

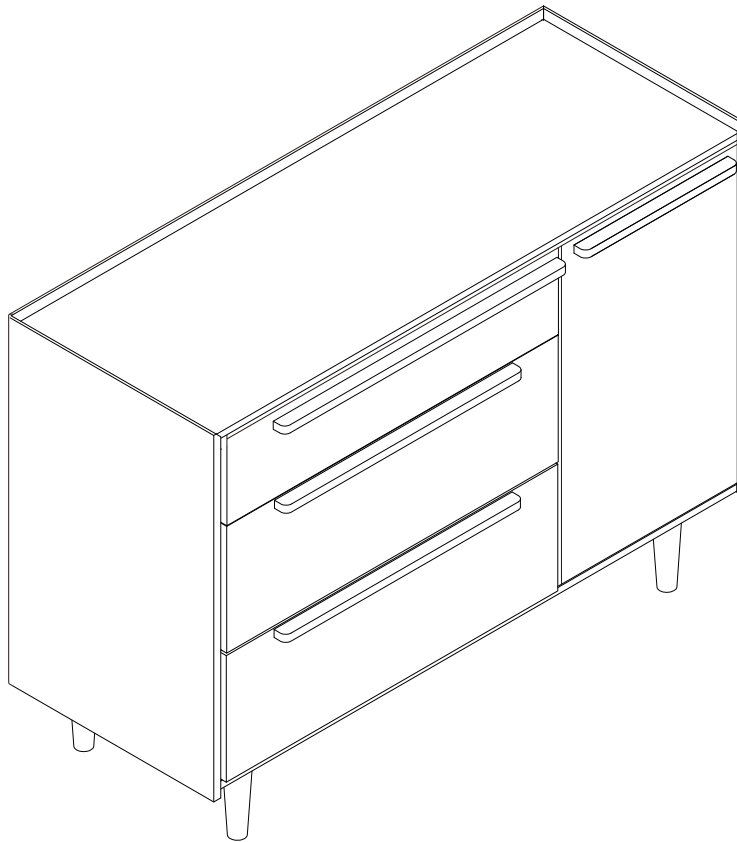

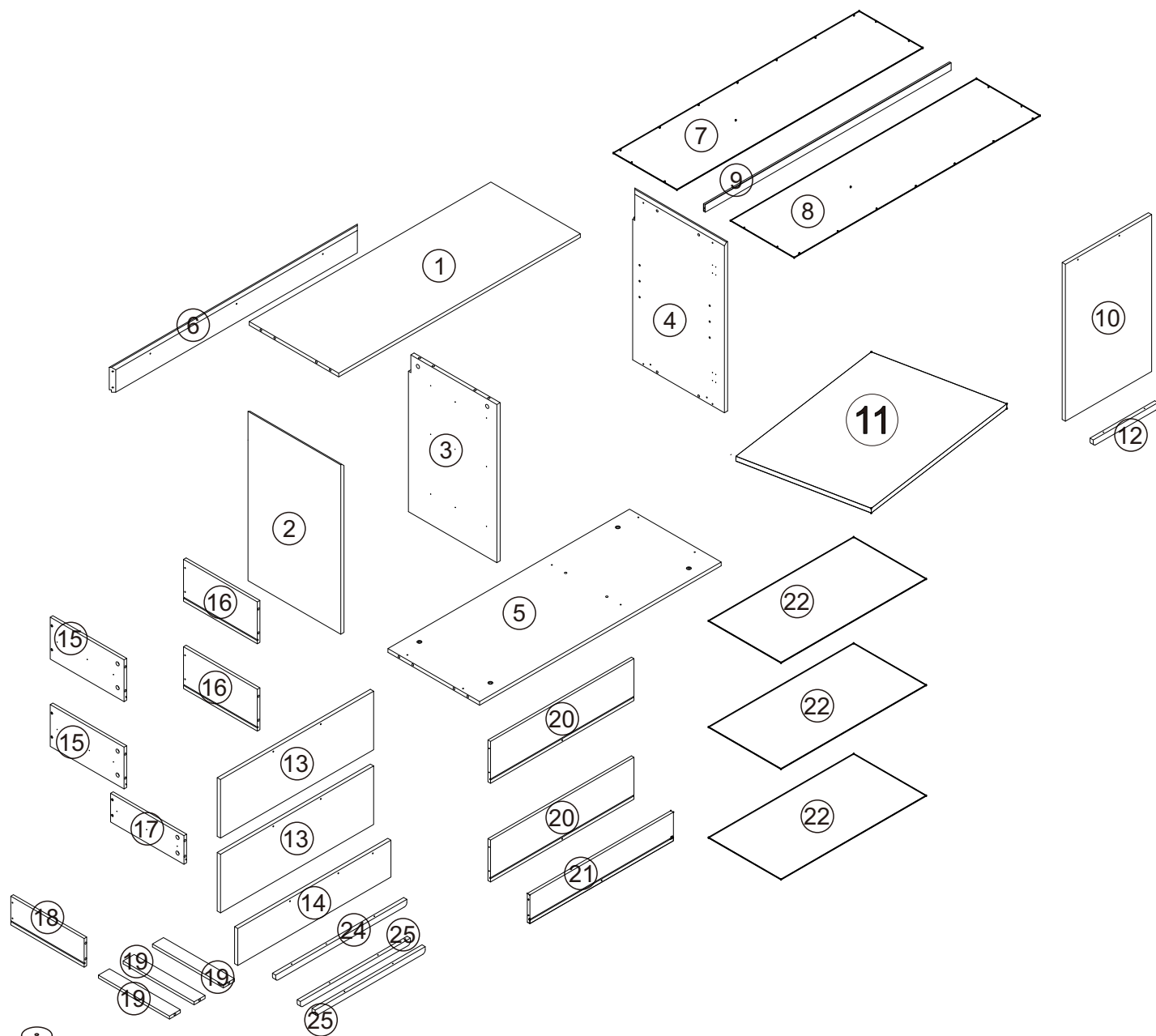









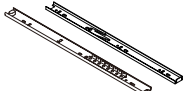

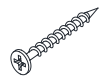



ASSEMBLY INSTRUCTION

Dresser WF298999AAG

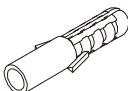







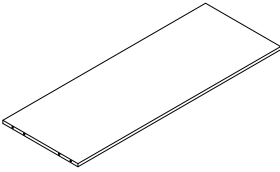
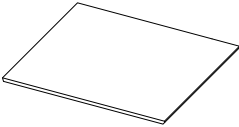
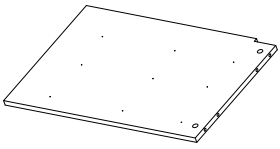
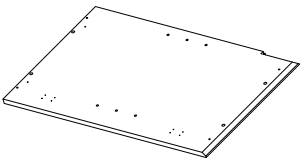
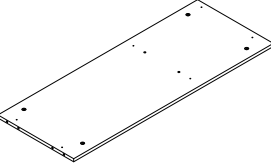
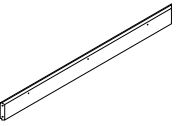
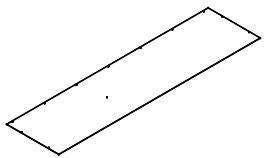
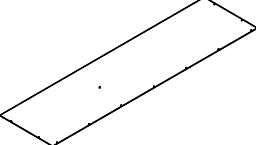
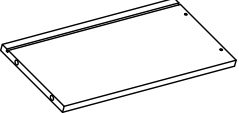
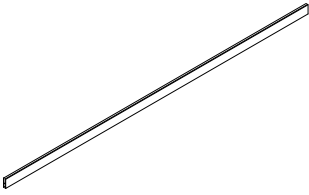
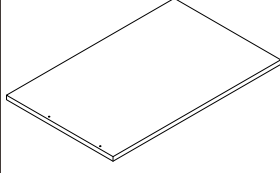
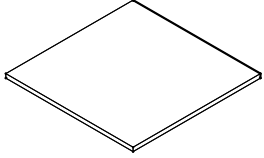
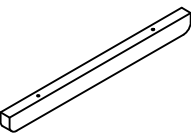

 23 x4

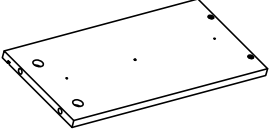
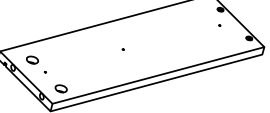
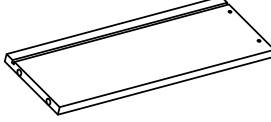
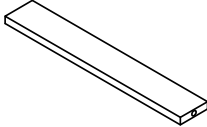
				
Ax25	Bx56	Cx6	Dx12	Ex25
				
Fx28	Gx4	Hx24	Ix2	Jx4
				
KX2	Lx2	Mx5	Nx2	Ox1
				
Px62	Qx4	Rx4	Sx2	Tx1

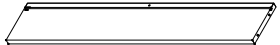
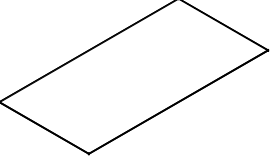
Box WF298999AAG

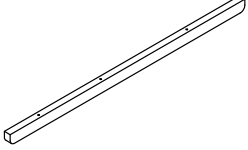
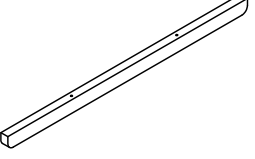
 <p>① X1</p>	 <p>② X1</p>	 <p>③ X1</p>	 <p>④ X1</p>	
 <p>⑤ X1</p>	 <p>⑥ X1</p>	 <p>⑦ X1</p>	 <p>⑧ X1</p>	 <p>⑯ X2</p>
 <p>⑨ X1</p>	 <p>⑩ X1</p>	 <p>⑪ X1</p>	 <p>⑫ X1</p>	
 <p>⑬ X2</p>	 <p>⑭ X1</p>	 <p>⑮ X2</p>	 <p>⑰ X1</p>	
 <p>⑱ X1</p>	 <p>⑲ X3</p>	 <p>⑳ X2</p>	 <p>㉑ X1</p>	
 <p>㉒ X3</p>	 <p>㉓ X4</p>	 <p>㉔ X1</p>	 <p>㉕ X2</p>	

step 1

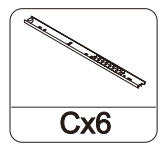
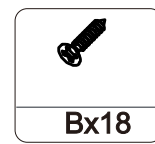
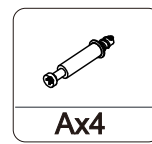
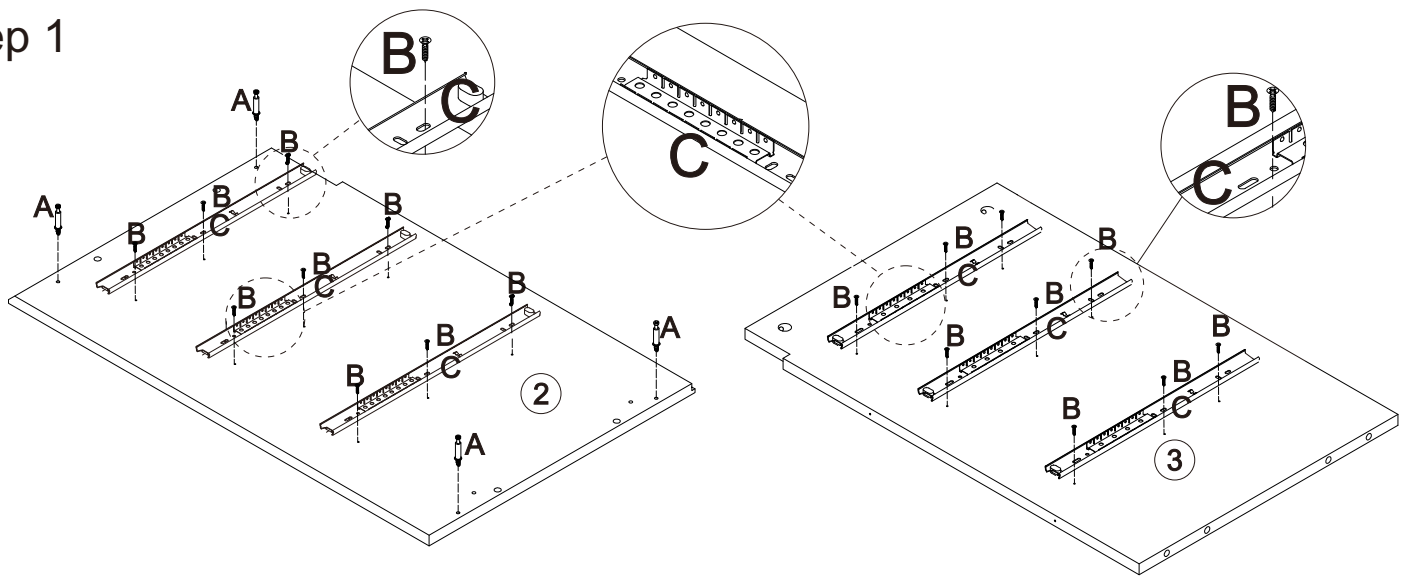

step 2

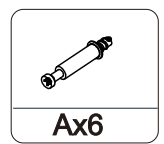
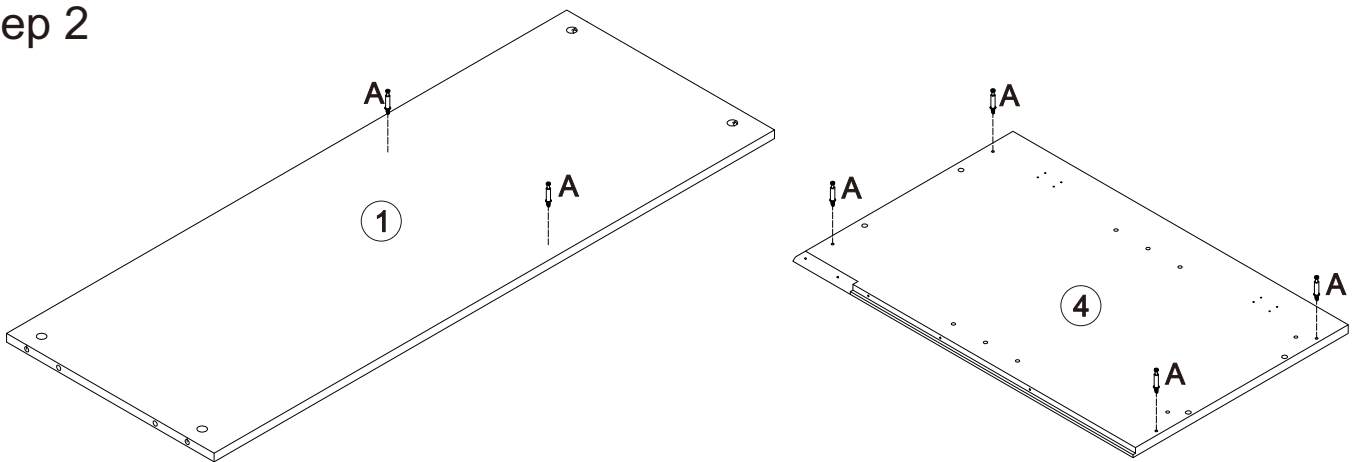

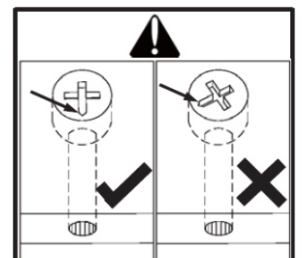
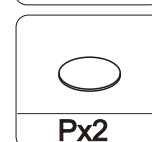
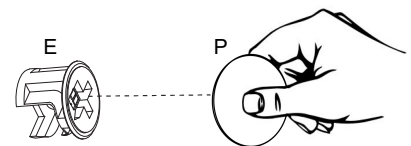
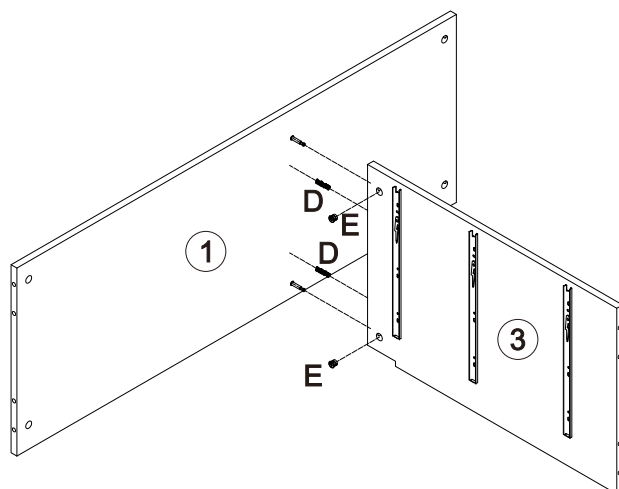

step 3



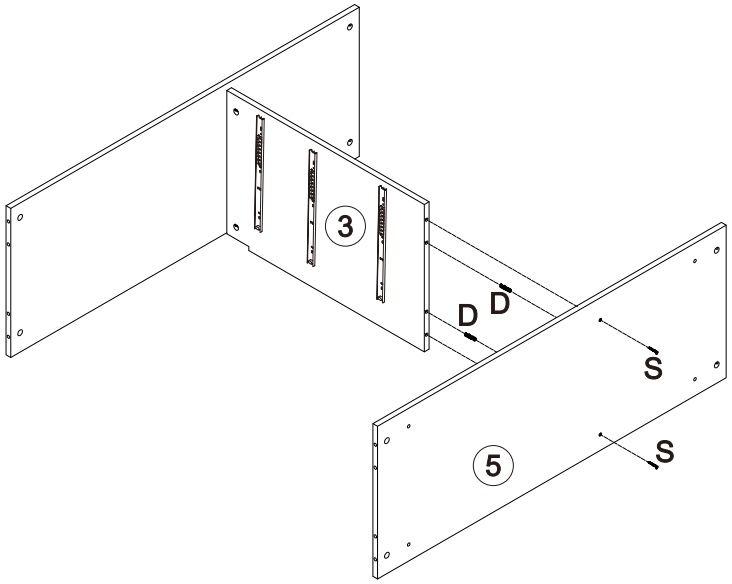

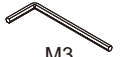

step 4

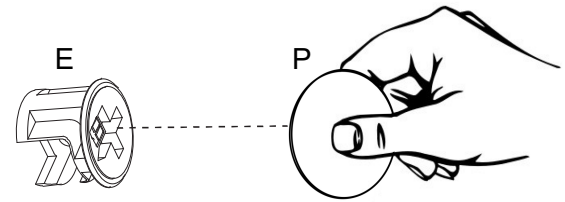
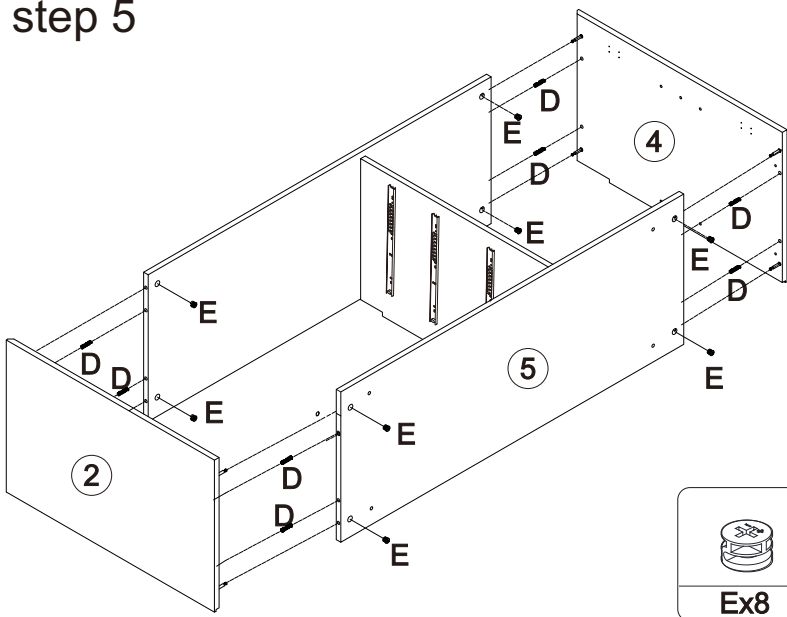

- 
Dx2
- 
Px2
- 
Sx4
- 
M3
Tx1



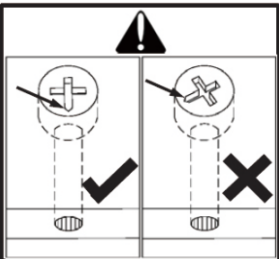

step 5

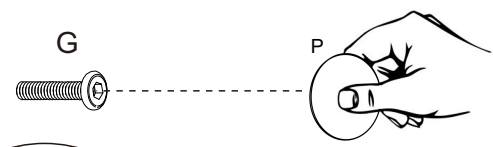
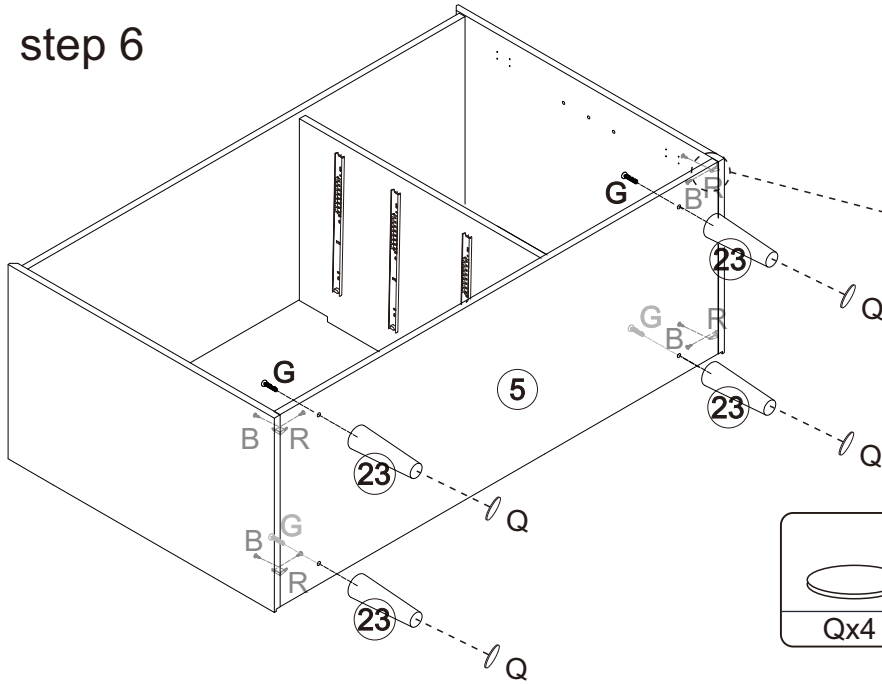

- 
Dx8
- 
Ex8
- 
Px8
- 

step 6

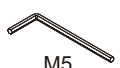

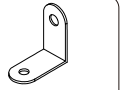
- 
Bx8
- 
Gx4
- 
Qx4
- 
M5
Ox1
- 
Px4
- 
Rx4

step 7

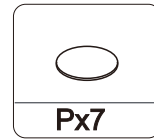
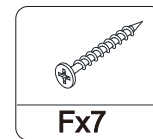
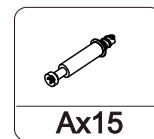
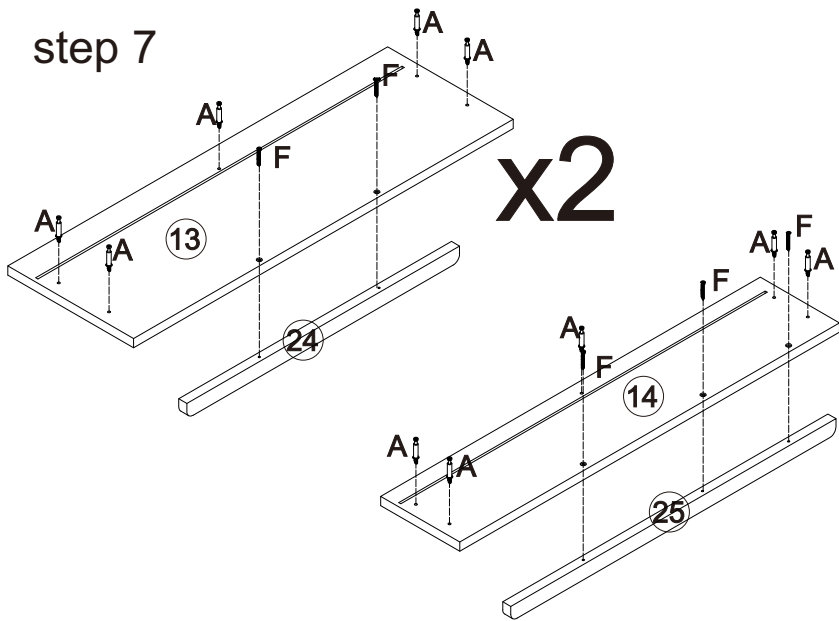

step 8

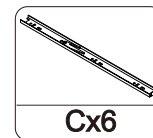
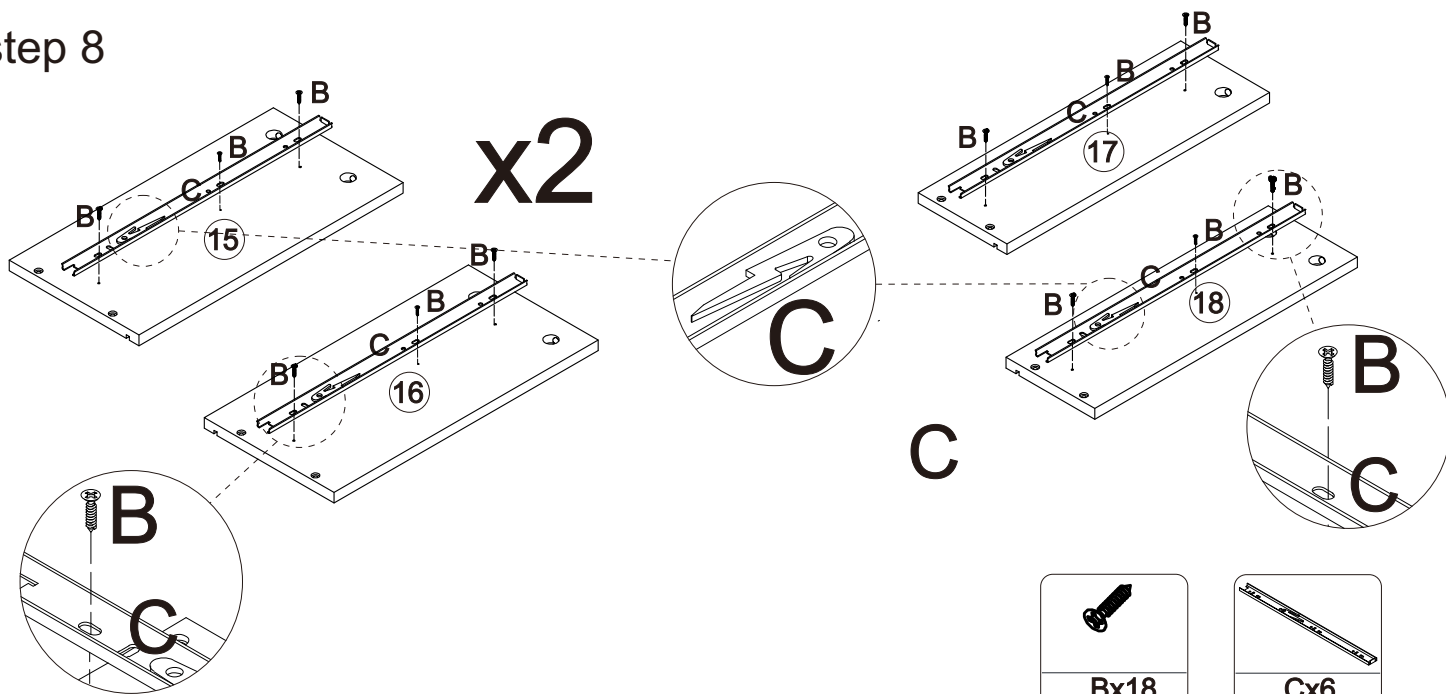

step 9

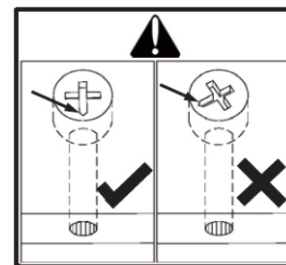
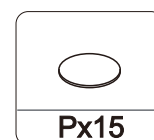
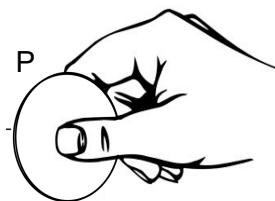
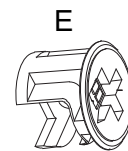
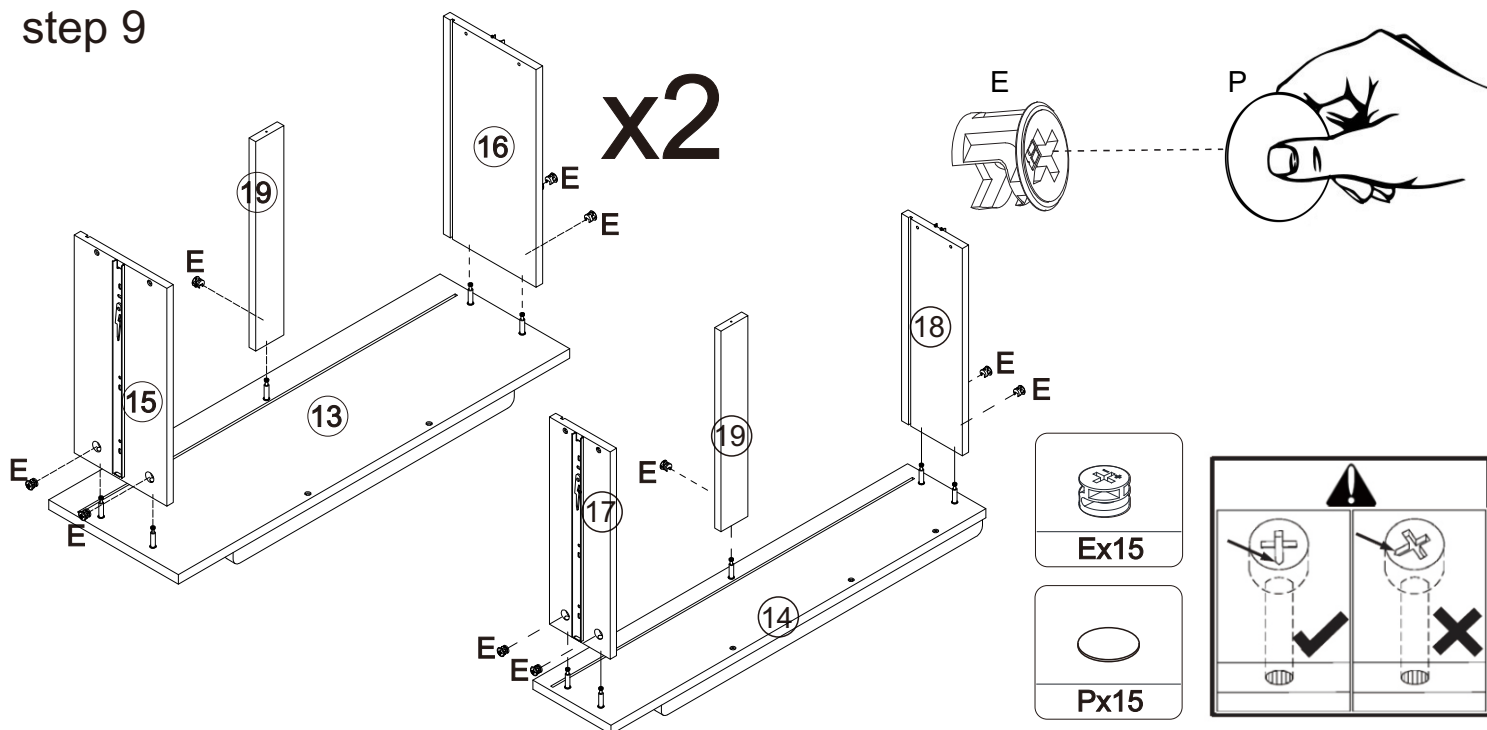

step 10

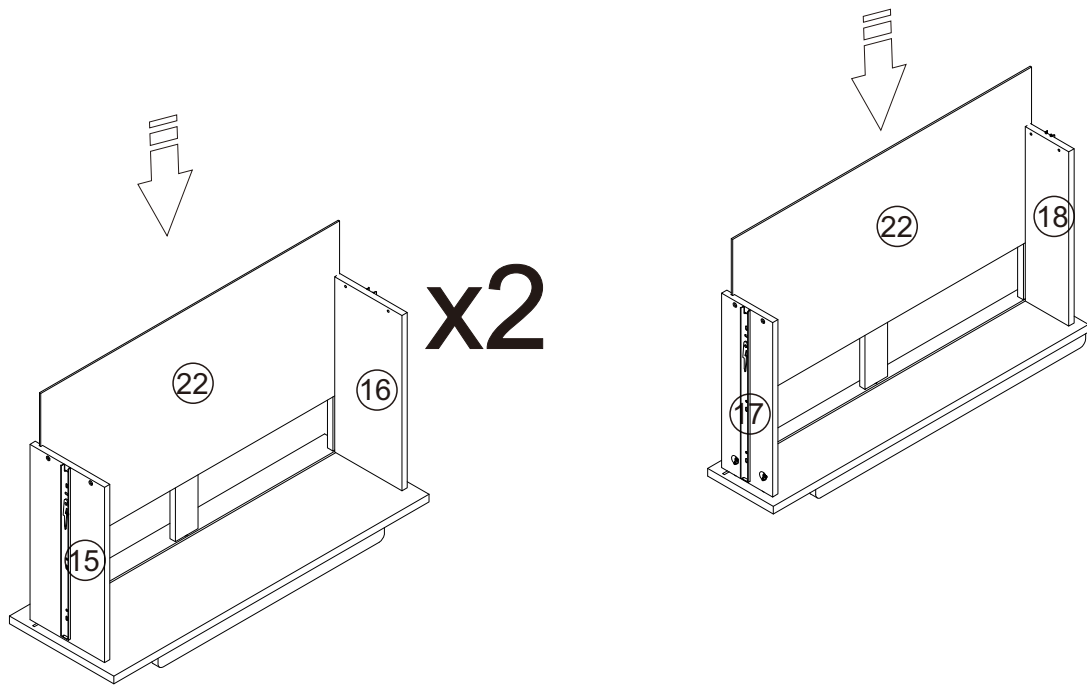

step 11

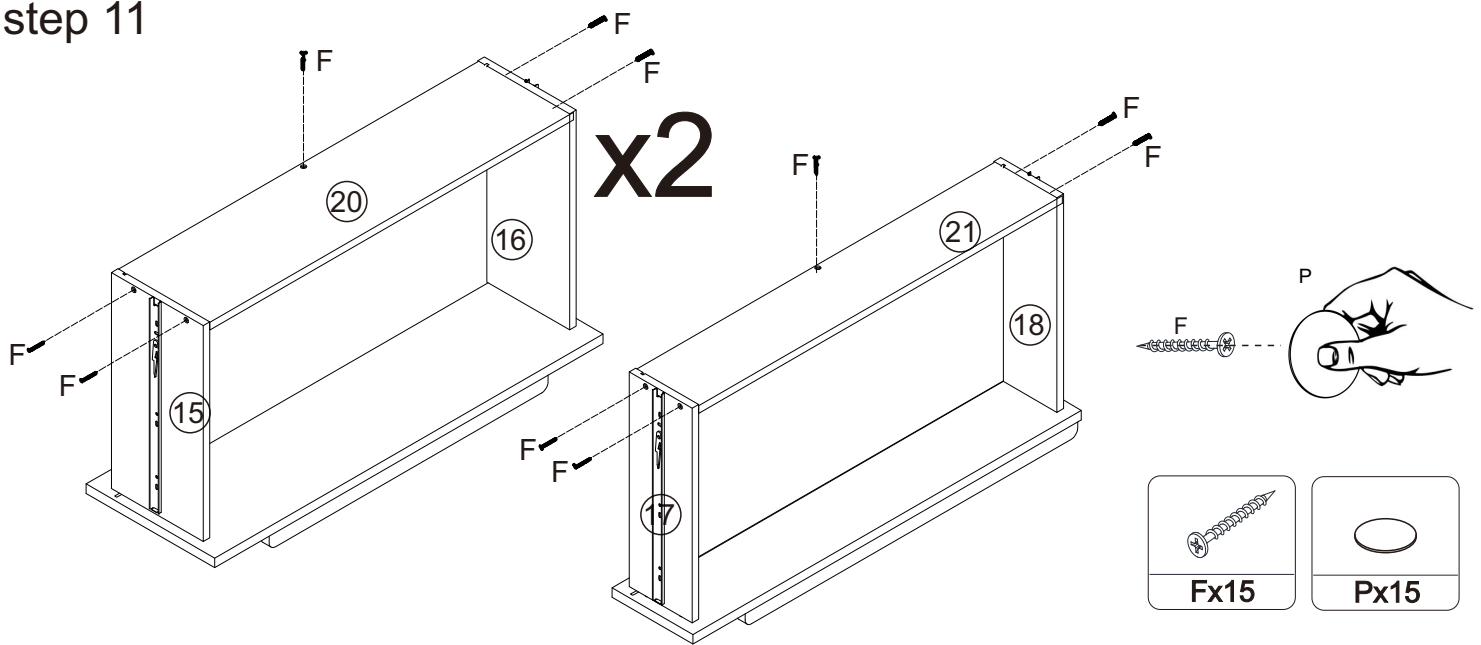

step 12

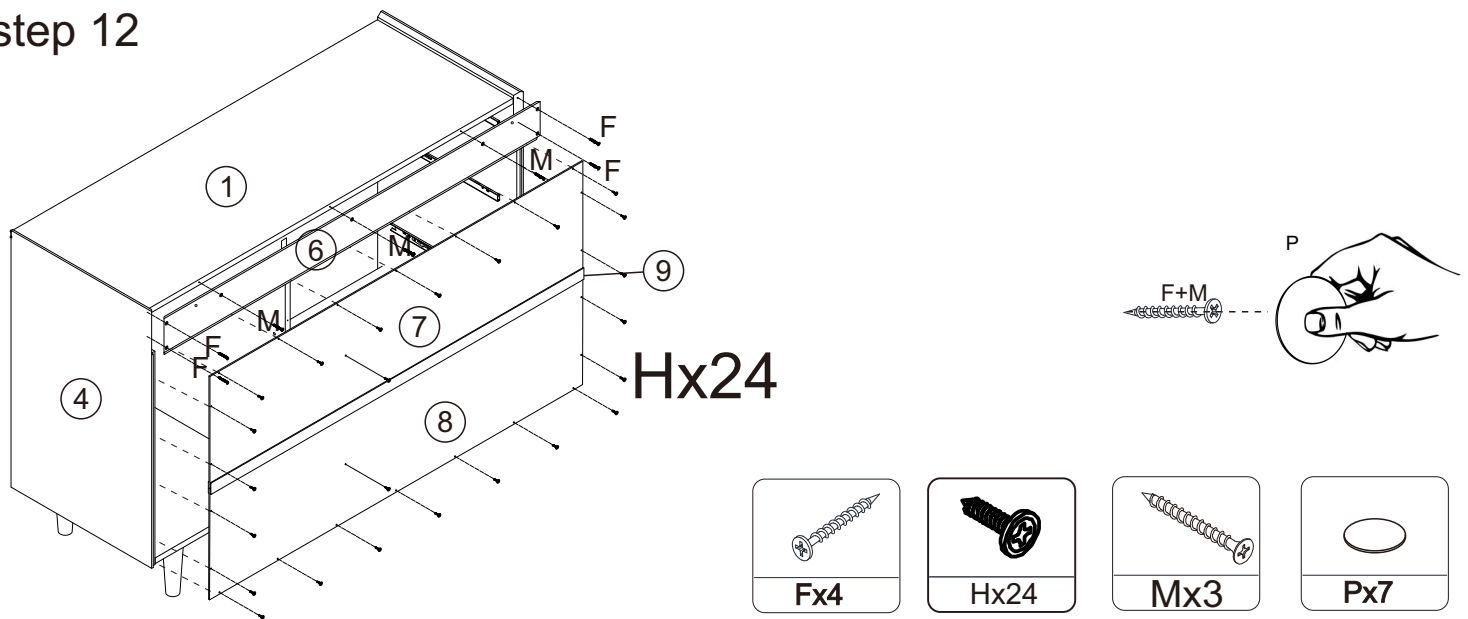

step 13

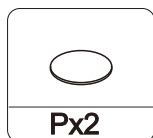
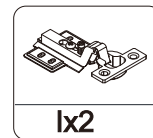
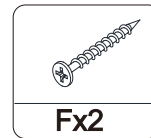
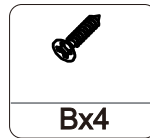
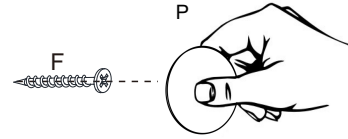
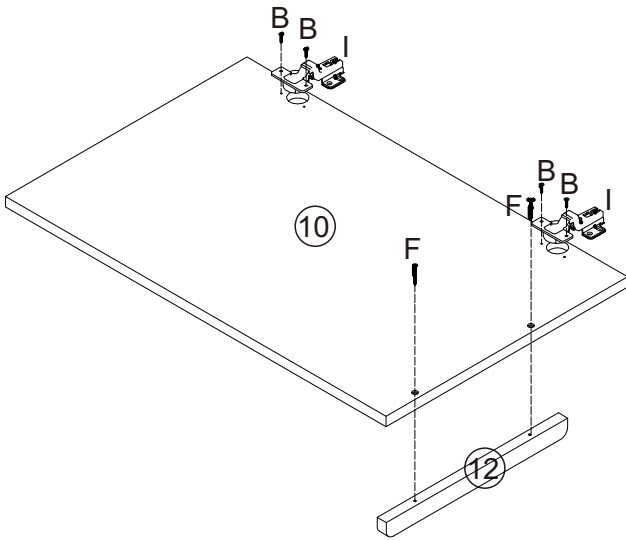

step 14

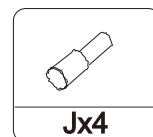
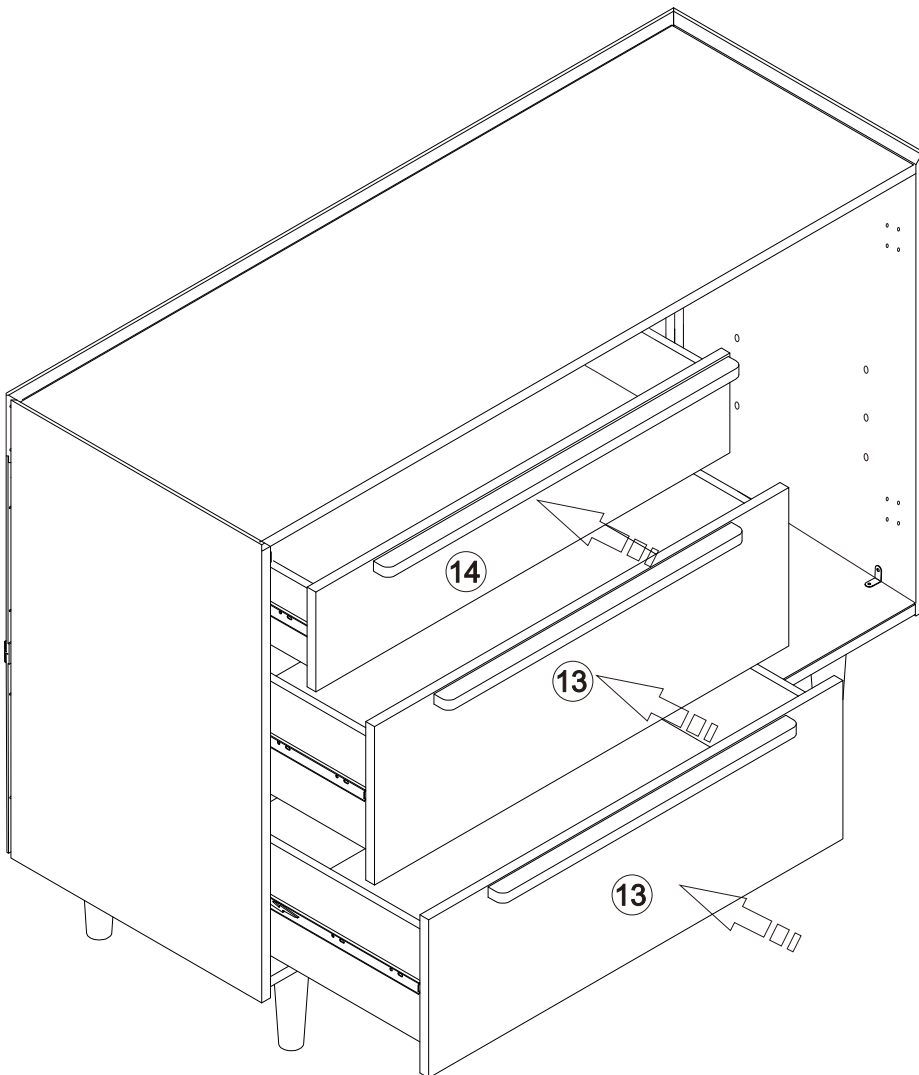

step 15

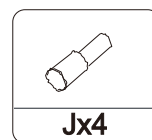
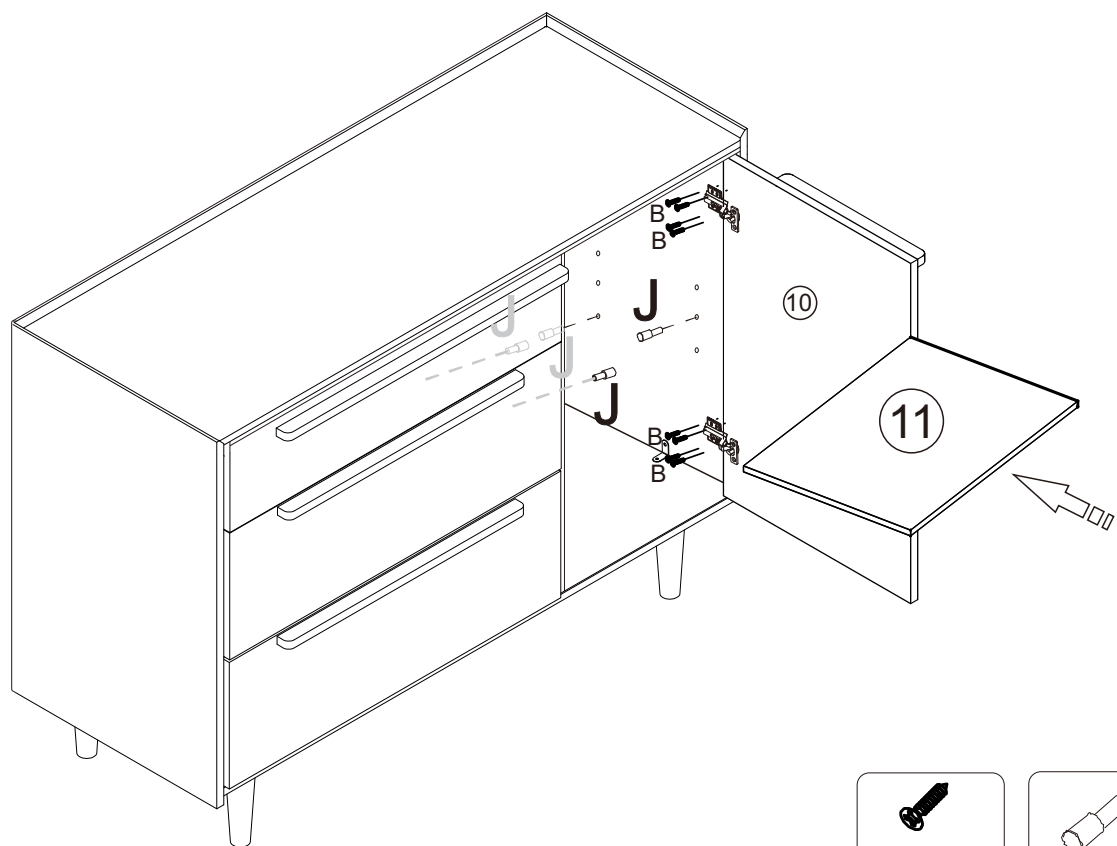

step 16

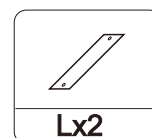
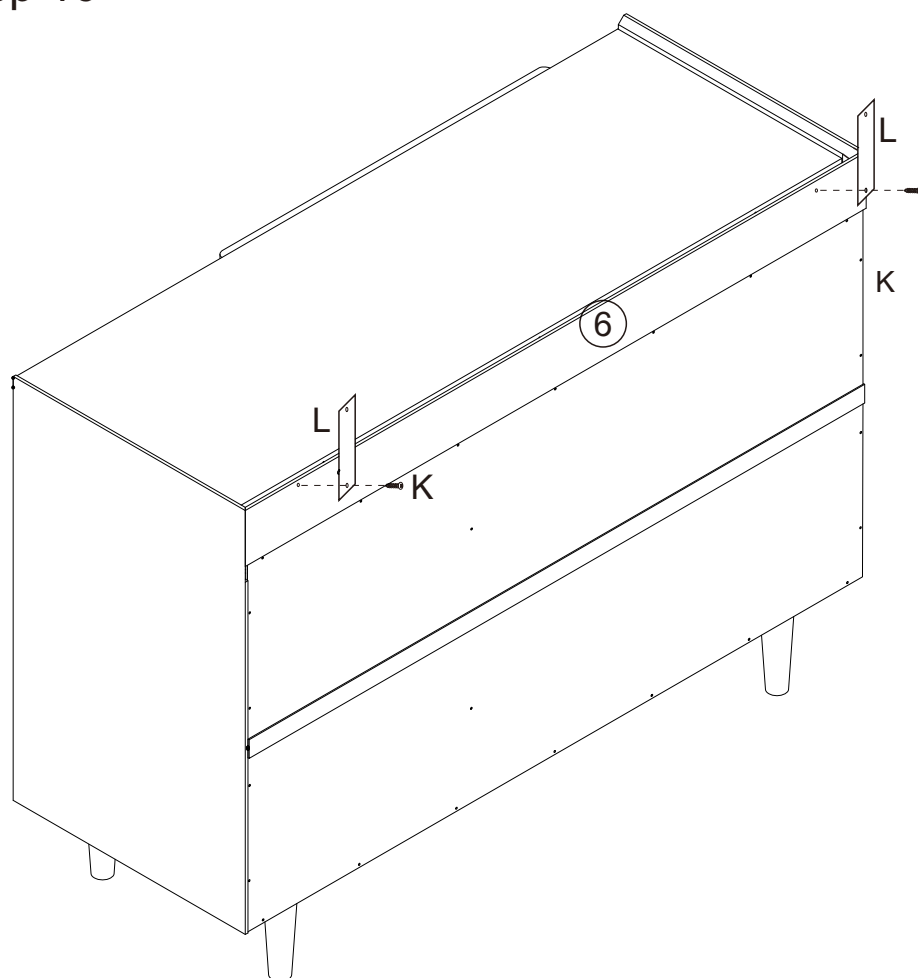

step 17

