

Assembly Instructions

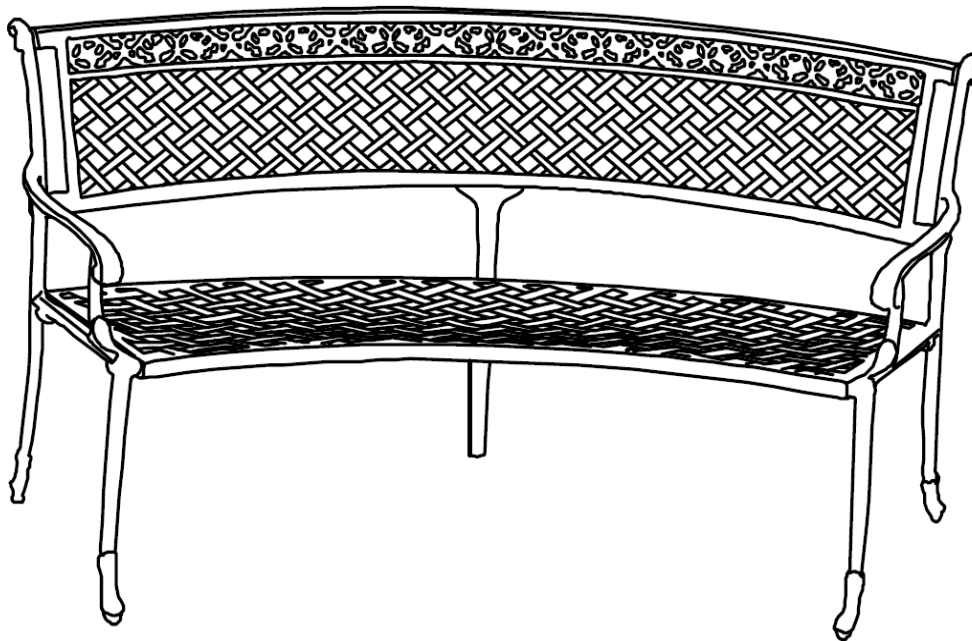

Caution: You must read this before you proceed.



BENCH



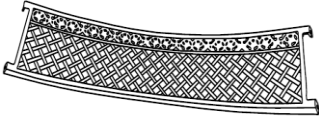
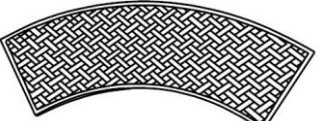



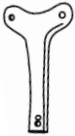





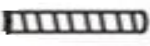

**CAUTION: This bench is NOT a TOY.
Keep your child/children at bay during the assembly process.**

Parts List

No.	Picture	Description	Qty
A		Backrest Panel	1
B		Seat Panel	1
C		Left Armrest (Labeled "Left")	1

D		Right Armrest(Labeled "Right")	1
E		Metal Connector Plate	1
F		Leg	1

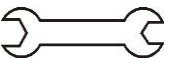
Hardware

No.	Picture	Description	Qty
①		Bolt(M6*25mm)	2
②		Bolt(M6*16mm)	3
③		Bolt(M8*35mm)	9
④		Washer(8mm)	9
⑤		Spring Washer(8mm)	9
⑥		Nut(8mm)	9
⑦		Bolt(M10*30mm)	3
⑧		Washer(10mm)	3
⑨		Spring Washer(10mm)	3
⑩		Nut(10mm)	3
⑪		Screwdriver	1
⑫		Spanner	1
⑬		Spanner	1
⑭		Plastic Nut Cap	5

Assembly Preparation

Before Beginning Assembly:

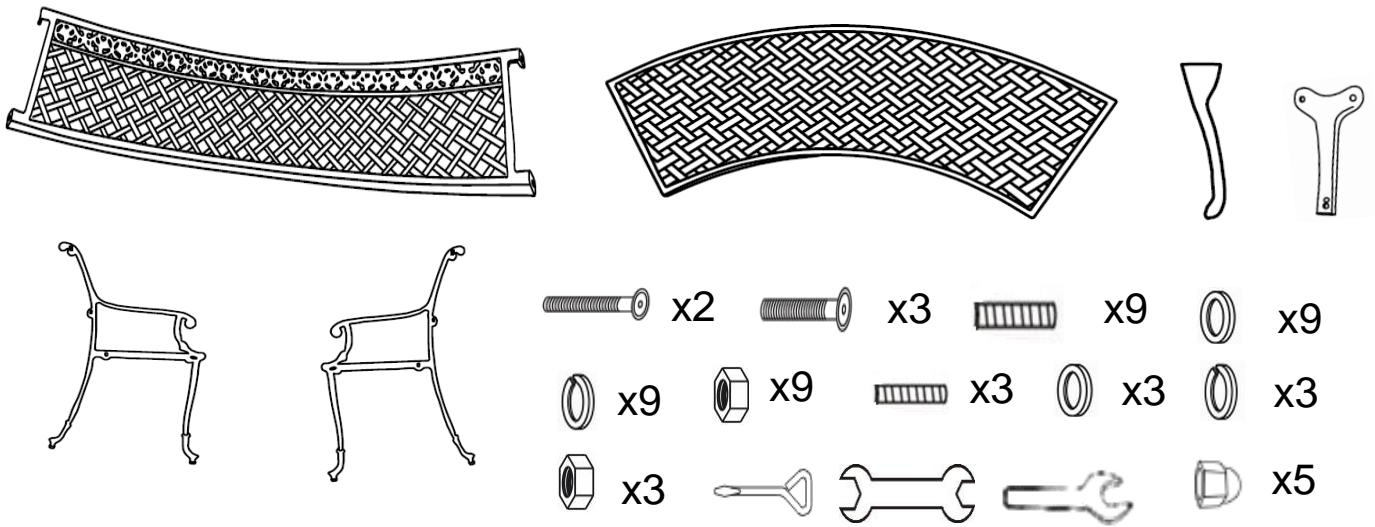

- Read instructions, cover to cover-
- Have 2 to 4 adults on hand for assembly-
- Do not assemble on flooring or carpet-
- Assemble on a clean non-marring surface (packing foam)-
- Save all packaging until finished-

Assembly Steps

Overview

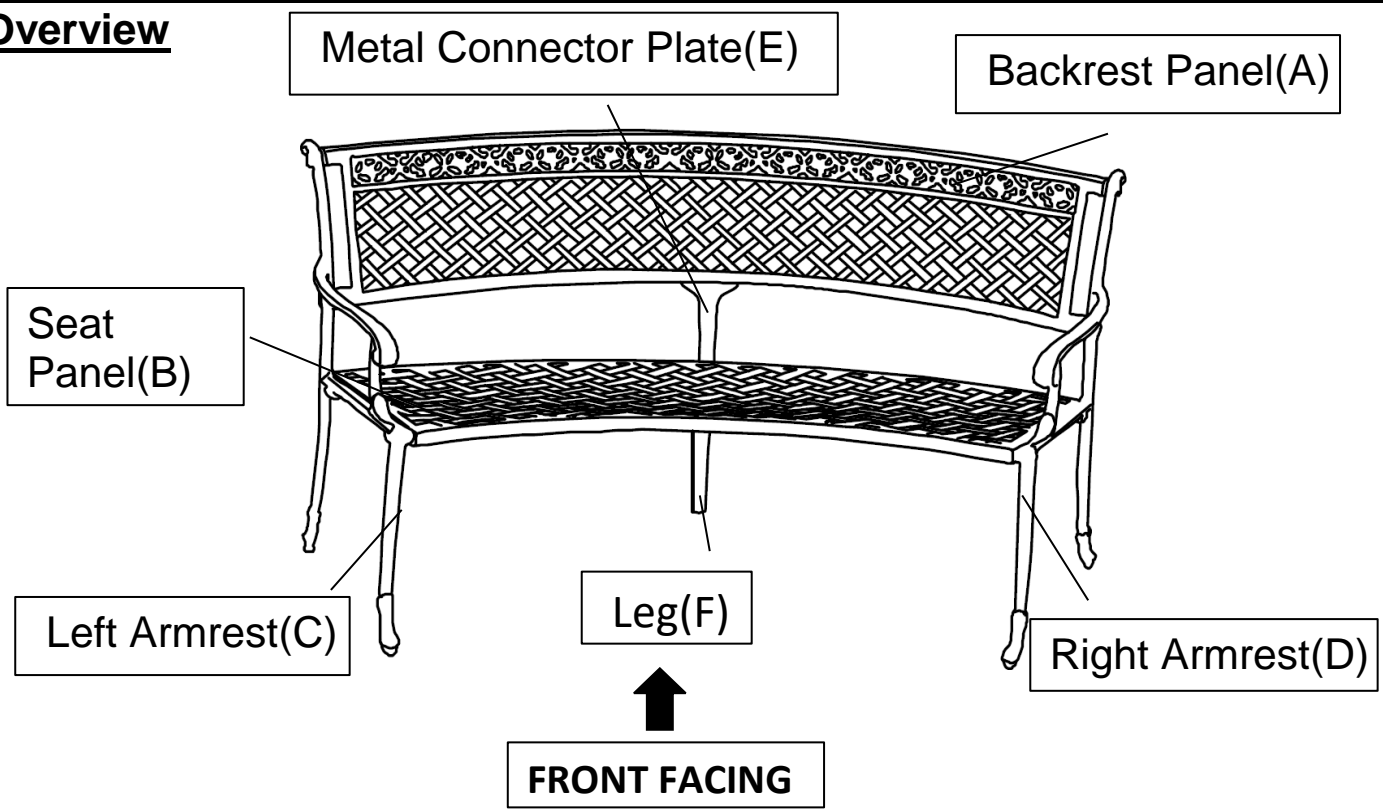

This Bench has multiple parts and may require up to some 30 minutes to assemble. To give you an overview of the Chair parts, the above picture is to help you put the various parts into perspective. Please read through the instructions here below to familiarise the parts and steps before assembly.

Step 1

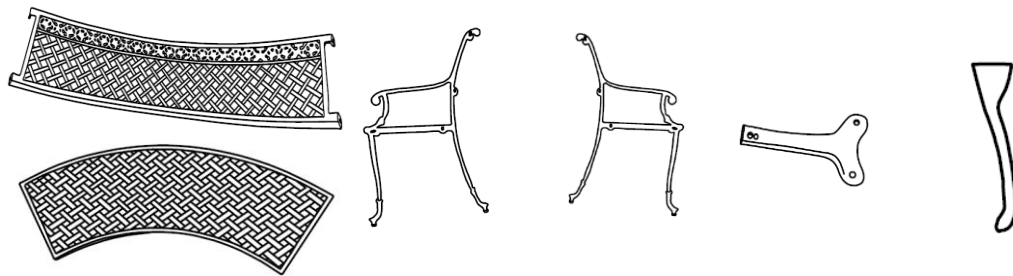

Unpack and place all parts on a clean non-marring surface.

Step 2

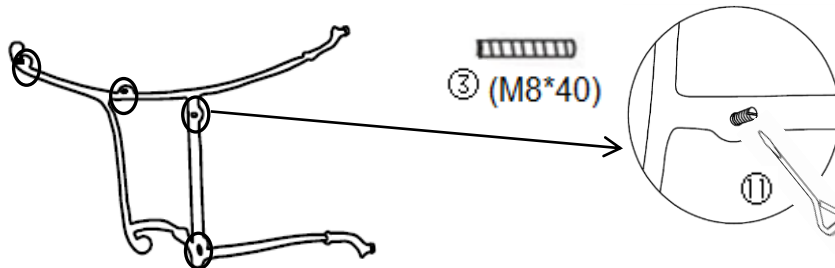

Place the Left Armrest (C) on the floor and lock four M8*35mm Bolts (3) to the mounting positions by using the Screwdriver (11).

Step 3

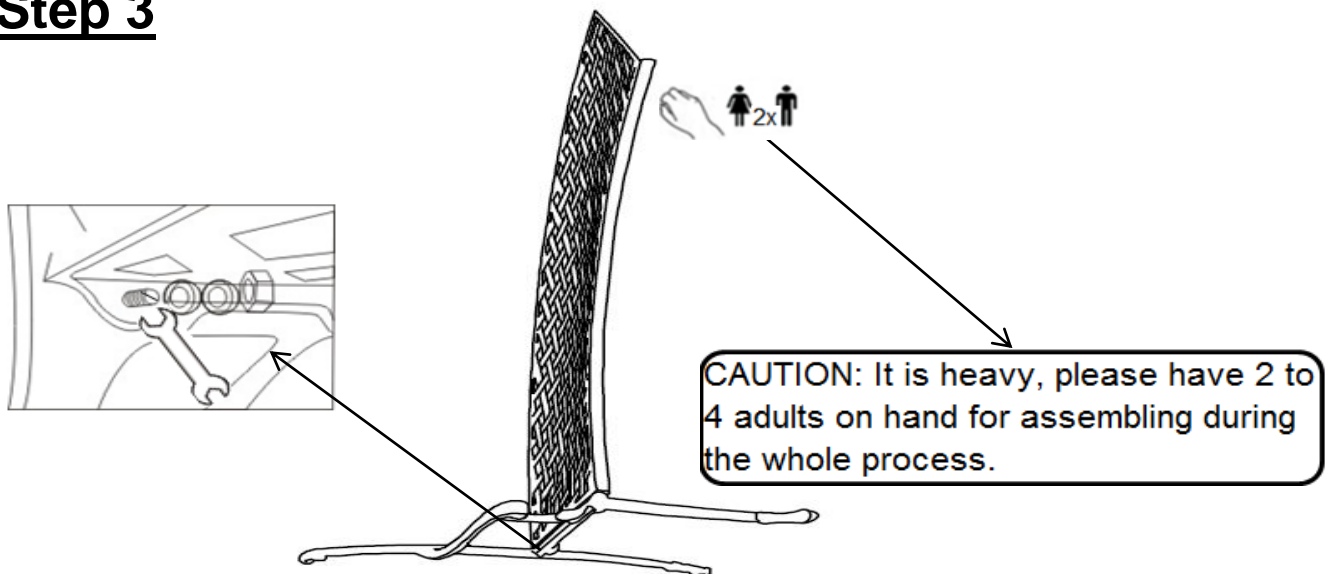

Hold the Seat Panel (B) up and align the mounting positions to the Bolts (3) on the Left Armrest (C).

Attach the Seat Panel (B) to the Left Armrest (C) at Bolts (3) using Washers (4), Spring Washers (5) and Nuts (6) with Spanner (12).
DO NOT OVERTIGHTEN.

Step 4

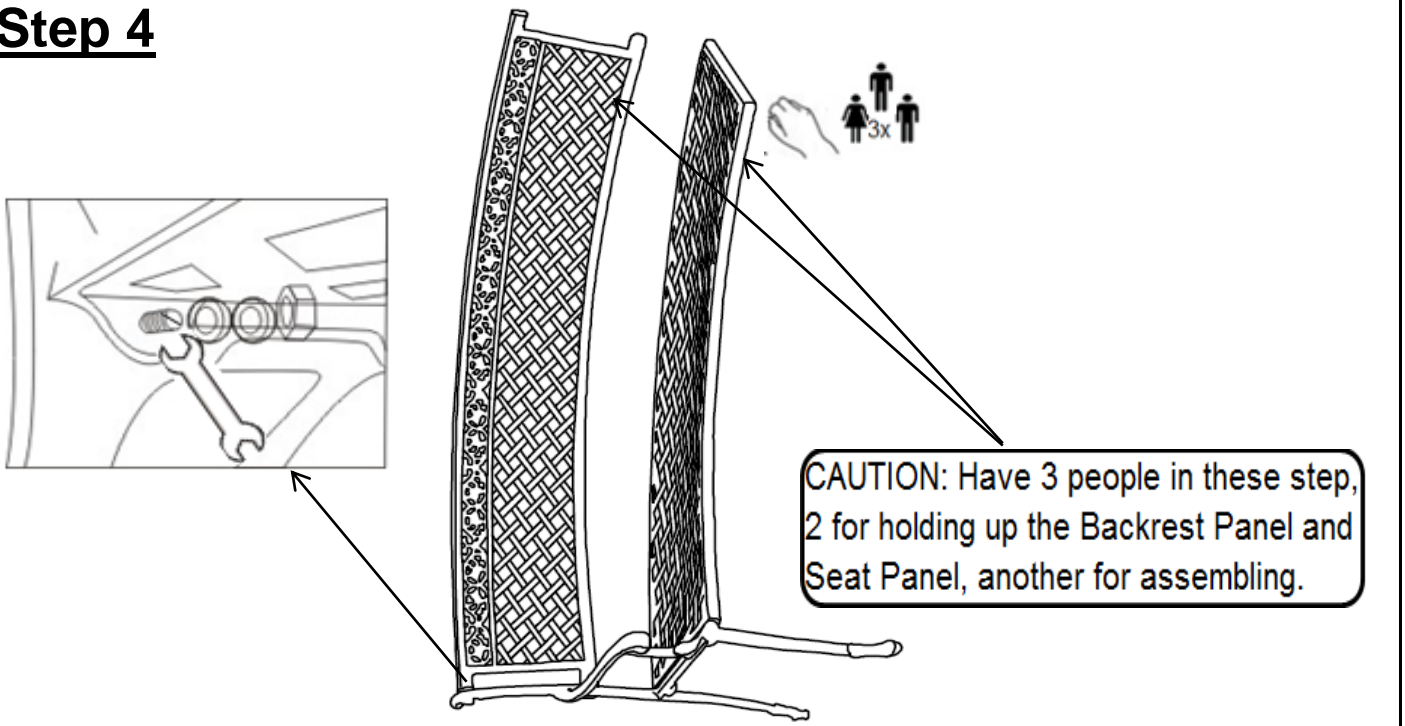

Hold the Backrest Panel(A) up and align the mounting positions to the two Bolts(③) on the Left Armrest(C).

Attach the Backrest Panel(A) to the Left Armrest(C) at Bolts(③) using Washers(④), Spring Washers(⑤) and Nuts(⑥) with Spanner(⑫).

DO NOT OVERTIGHTEN.

Step 5

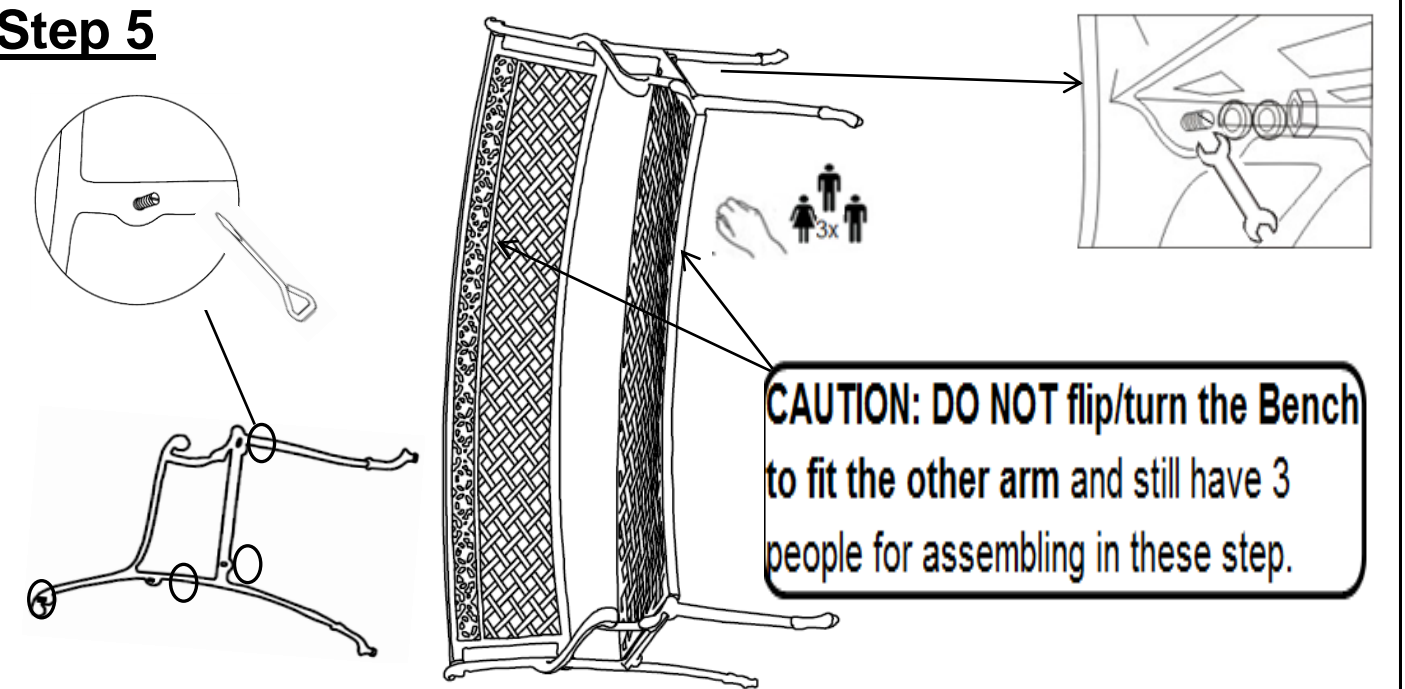

Lock four M8*40mm Bolts(③) into the mounting positions of the Right Armrest(D) the same as you did in Step 1.

Attach the Seat Panel(B) and Backrest Panel(A) to the Right Armrest(D) at Bolts(③) using Washers(④), Spring Washers(⑤) and Nuts(⑥) with Spanner(⑫).

DO NOT OVERTIGHTEN.

Step 6

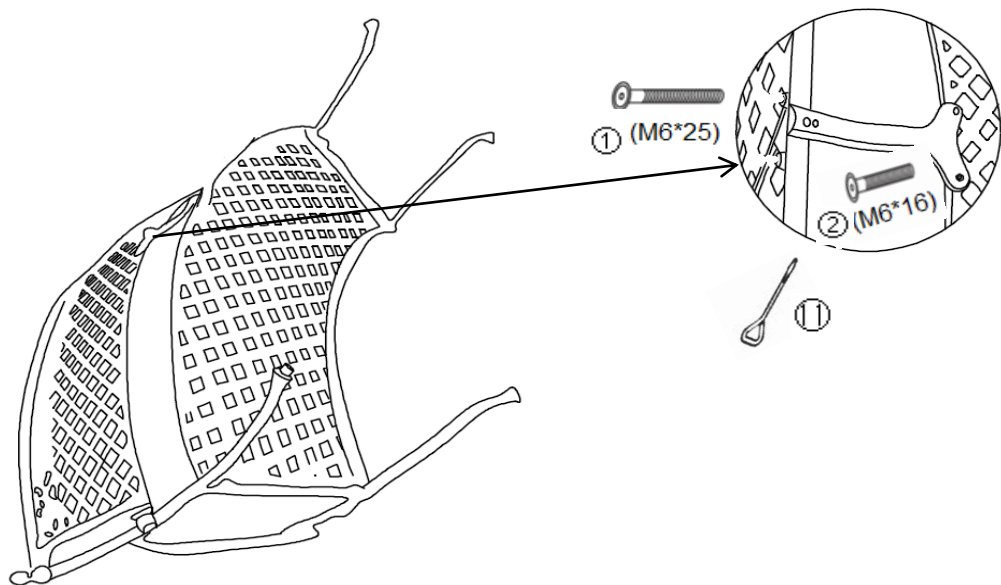

Position the Bench as shown in the picture.

Use the Metal Connector Plate(K) to connect the Backrest Panel(A) and Seat Panel(B) by using one M6*25mm Bolt(①) and two M6*16mm Bolts(②) with Allen Key(⑪).

DO NOT OVERTIGHTEN.

Step 7

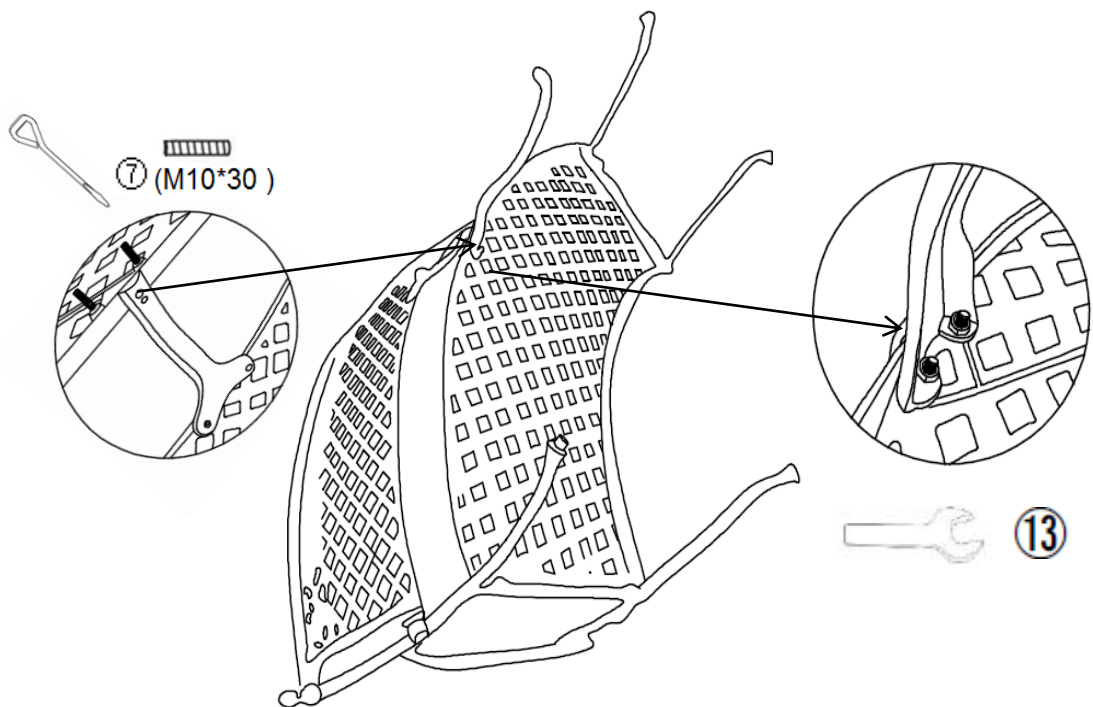

Lock two M10*30mm Bolts(⑦) to the underside of the Seat Panel(B) by using the Screwdriver(⑪).

Then align the mounting position on the Leg(F) to the two M10*30mm Bolts(①) and lock them into position by using the Washers(⑧), Spring Washers(⑨) and Nuts(⑩) with the Spanner(⑬).

Now, proceed to: fully and securely, tighten ALL bolts, at ALL joints.

Step 8

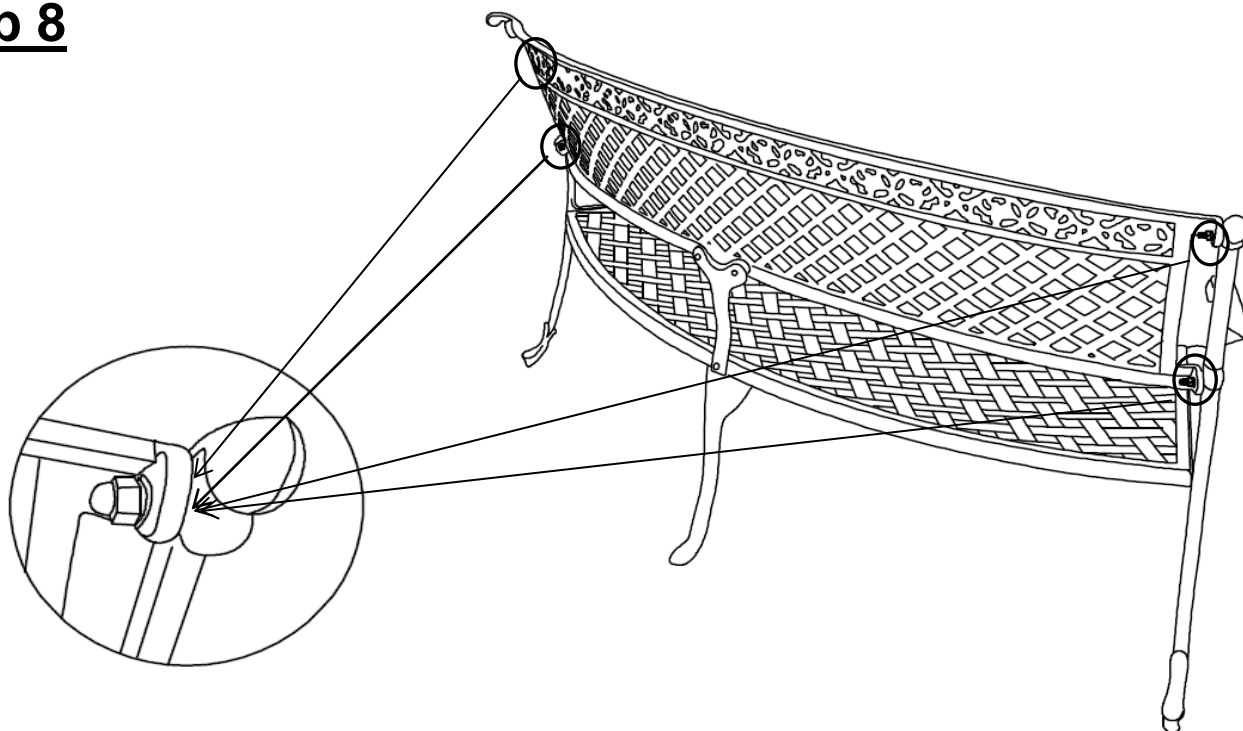

Turn the Bench rightside up.
Lock the Plastic Nut Cap(14) to the four bolts on the Backrest Pannel(A).

Step 9

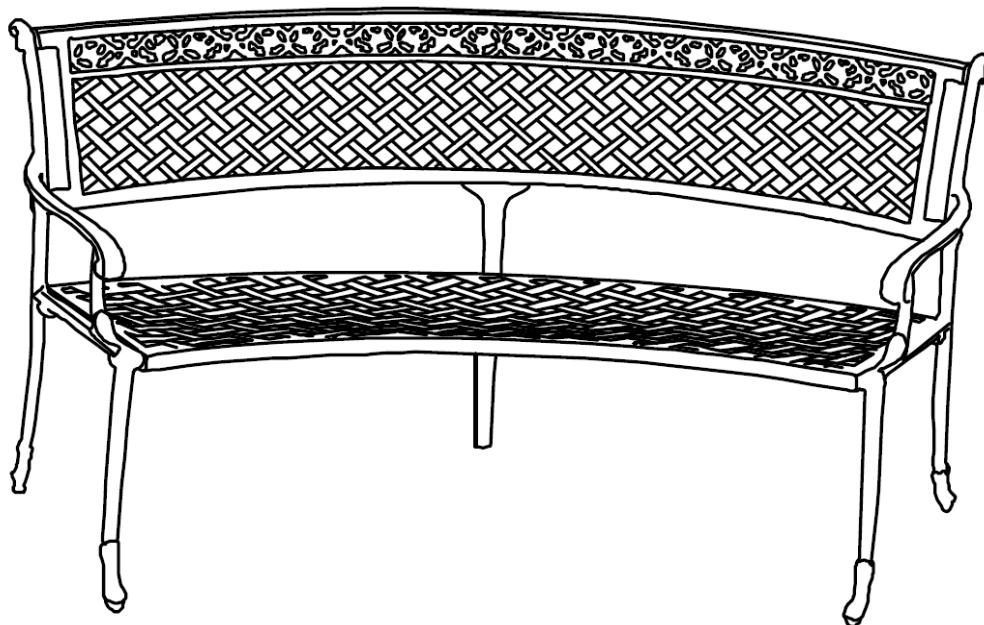









Adjust the Pre-installed Rubber Levelers on the Legs until the Bench is level to the ground.

This Bench is now fully assembled and ready for use.

Caution: This bench can only be used on a flat, level surface.

Care & Maintenance

-  Do not put hot items directly on furniture surface.
 -  Do not clean furniture with harsh cleansers or polish.
 -  To obtain the longest lifespan of your outdoor products, minimizing exposure to direct sunlight is recommended.
 -  Children should not climb or jump on the furniture.
 -  Do not write on furniture without a padded barrier to protect the surface.
 -  To obtain the longest lifespan of your outdoor products, avoid extended and lengthy exposure to rain, snow, and direct sunshine. Whenever possible cover the product and /or place under patio or awnings.
 -  Not for commercial use. For residential use only .
 -  Stains may be removed with mild soap solution and damp cloth.
-
-  Dust and pick-up spills using a clean, non-colored, lint-free cloth .