

To deodorize the leather

Leave your chair in the shade for 1-2 days.



For longer use

Re-tighten bolts every 6 months by using the enclosed allen-key.

*Using an electric drill can damage the chair. Please re-tighten bolts manually.

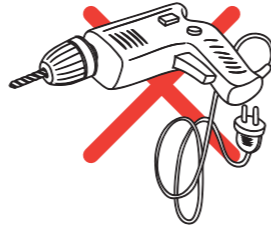
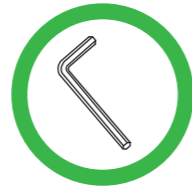

• Cautions

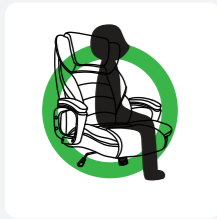

This product is for one person only.



DO NOT use the chair unless all bolts, screws, and knobs are fully tightened.



DO NOT use the chair if any of the parts is missing or damaged.



DO NOT stand on the chair to use as a step stool or ladder.

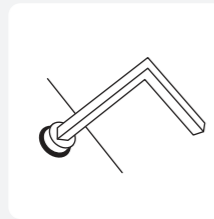

Regularly check if all bolts, screws, and knobs are fully tightened.



Please be careful. Some of the parts are sharp and heavy.

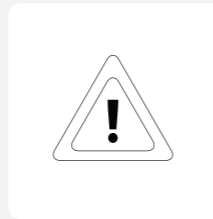

Failure to follow these warnings and instructions could result in serious injury.

Read the instructions carefully.

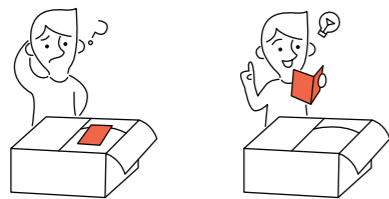

Follow the assembly steps.

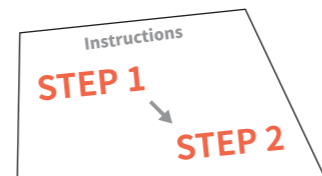

OFFICE CHAIR

ASSEMBLY INSTRUCTION

Contents

- Instructions
- Cautions



Please make sure all the parts are included.

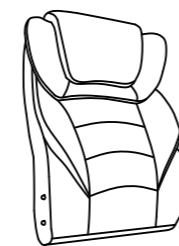

AX1



BX1

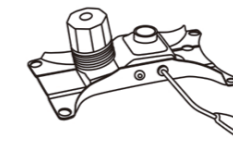

CX1

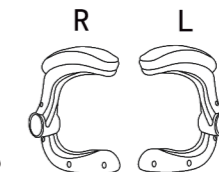

DX2



EX1



FX1

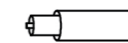

GX1



HX5

I*4 (M6*20mm)



J*8 (M6*25mm)



K*8



• Instructions

✘ NOTICE

Please use the allen key included instead of an electric drill.

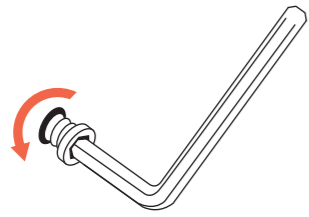

TIPS!

Use the box for an easier assembly.

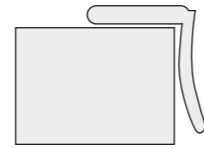

We recommend two people for the assembly process.

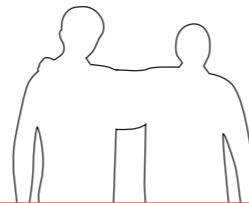

STEP 1

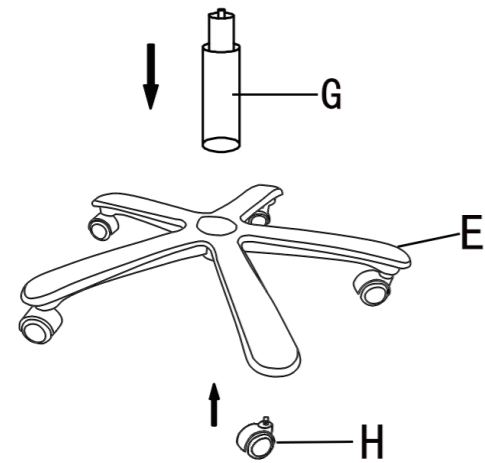

STEP 2

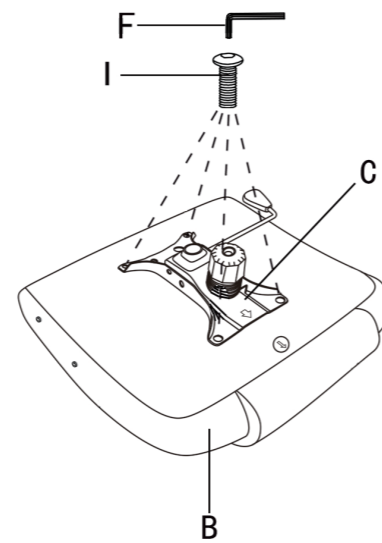

STEP 3

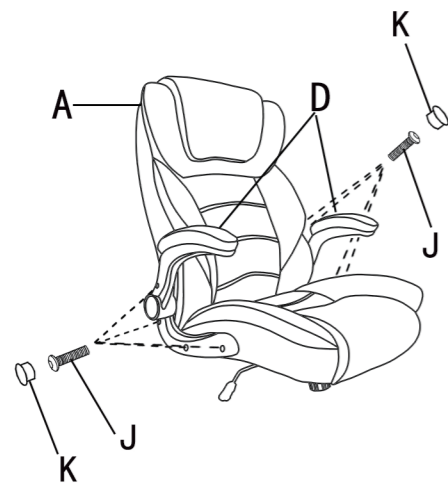

STEP 4

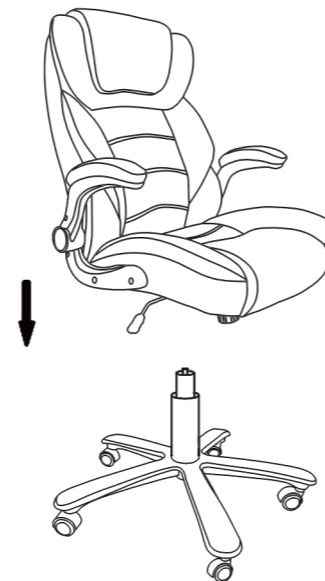

STEP 5



Enjoy your new favorite chair

Our goal is to create a perfect customer experience.

Let us know if you have any feedback.

Your comment motivates us to become a better team.