

(1) NAP-65

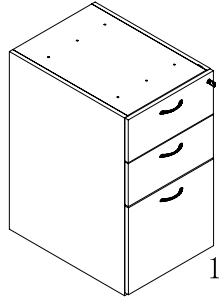

1PCS

(D) Leg Leveller

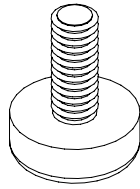

4PCS

(E7) Wood Screw

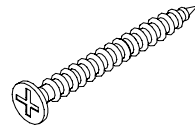

6PCS

STEP 2

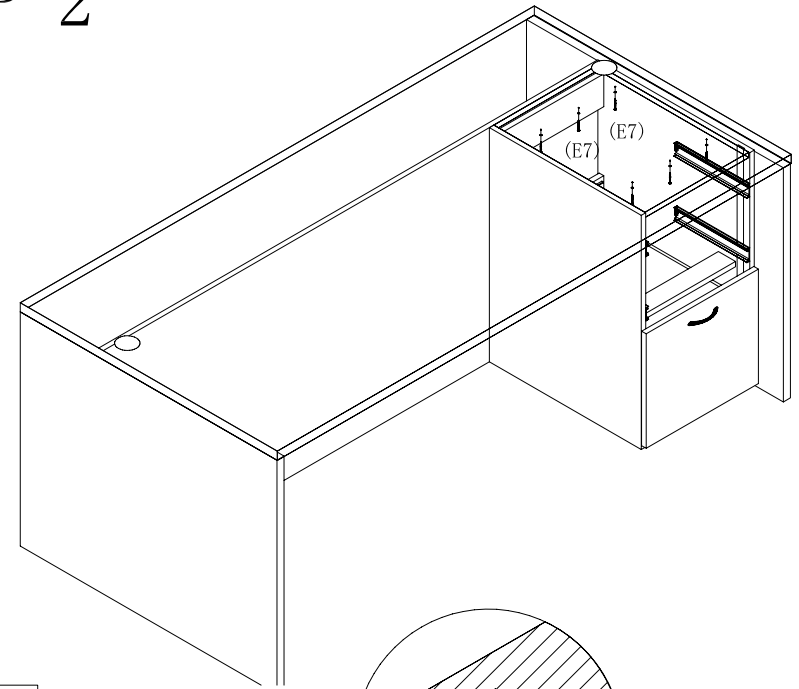

STEP 1

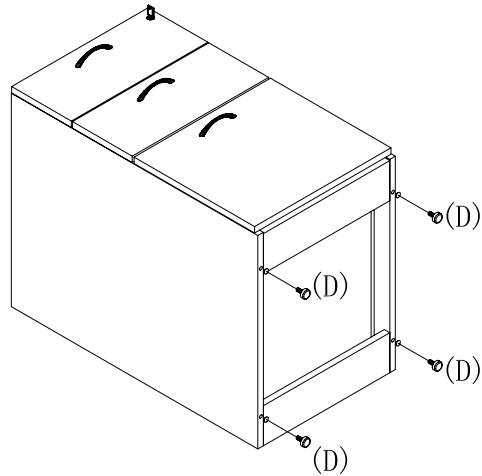

STEP 3

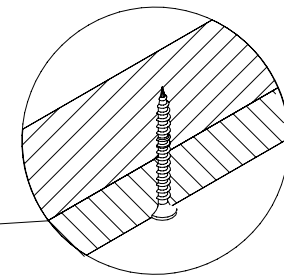
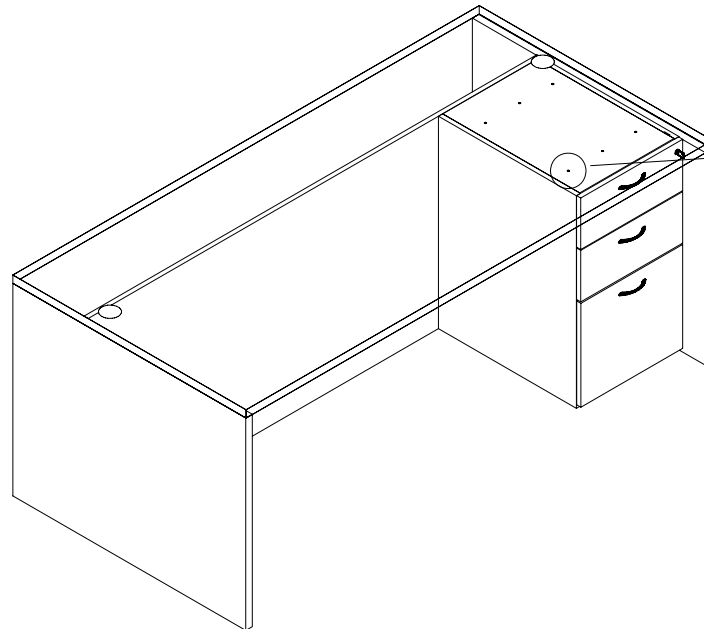

3 DRAWER PED

Always lay components on A clean, soft-cushioned surface during assembly.