

GLASS CHANDELLER

Product User Manual

DIRECTORY

1. Product Overview **1**

2. Product Parameters **2**

3. Product Installation **3**

4. After-sale Service **5**



Dear Customer,

Thank you for your order. We want to remind you to check the package. If you find anything damaged, don't panic right away because we included about 10% glass spare parts in the carton just in case.

Please follow our assembly instructions carefully or the video on this page to complete the partial assembly. If you're still confused, please send us a message on and we'll explain how to install.

If there is any problem, we will always be here to help you!

Hope you will enjoy!

1. PRODUCT OVERVIEW



A distinctively shaped acrylic glass element and a modern minimalist design will add style and a sense of space to your area. This gorgeous handmade discussion piece is suggested to decorate your house.

1.1 USE CASE

Color your space and mesmerize yourself and your guests with this stunning handmade conversation piece, recommend to decor your bedroom, living room, dining room, foyer, entryway, staircase, lobby, hallway, bathroom, office, bar, hotel, farmhouse etc.

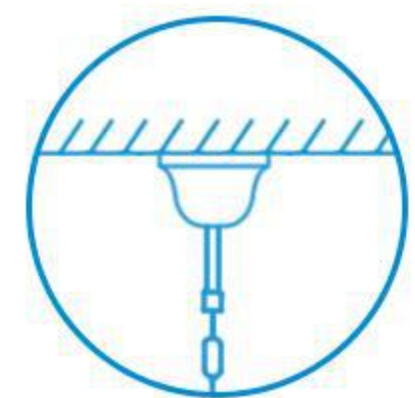

Flat Ceilings

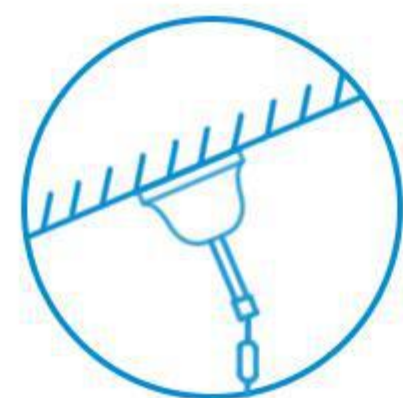

Sloped Ceilings

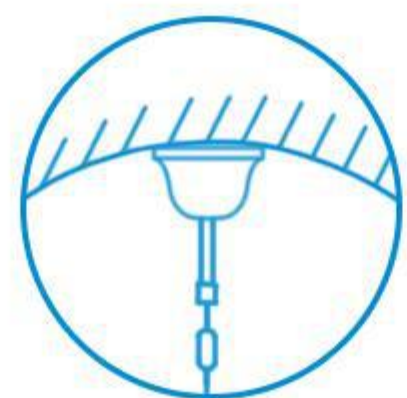

Vaulted Ceilings

2.PRODUCT PARAMETERS

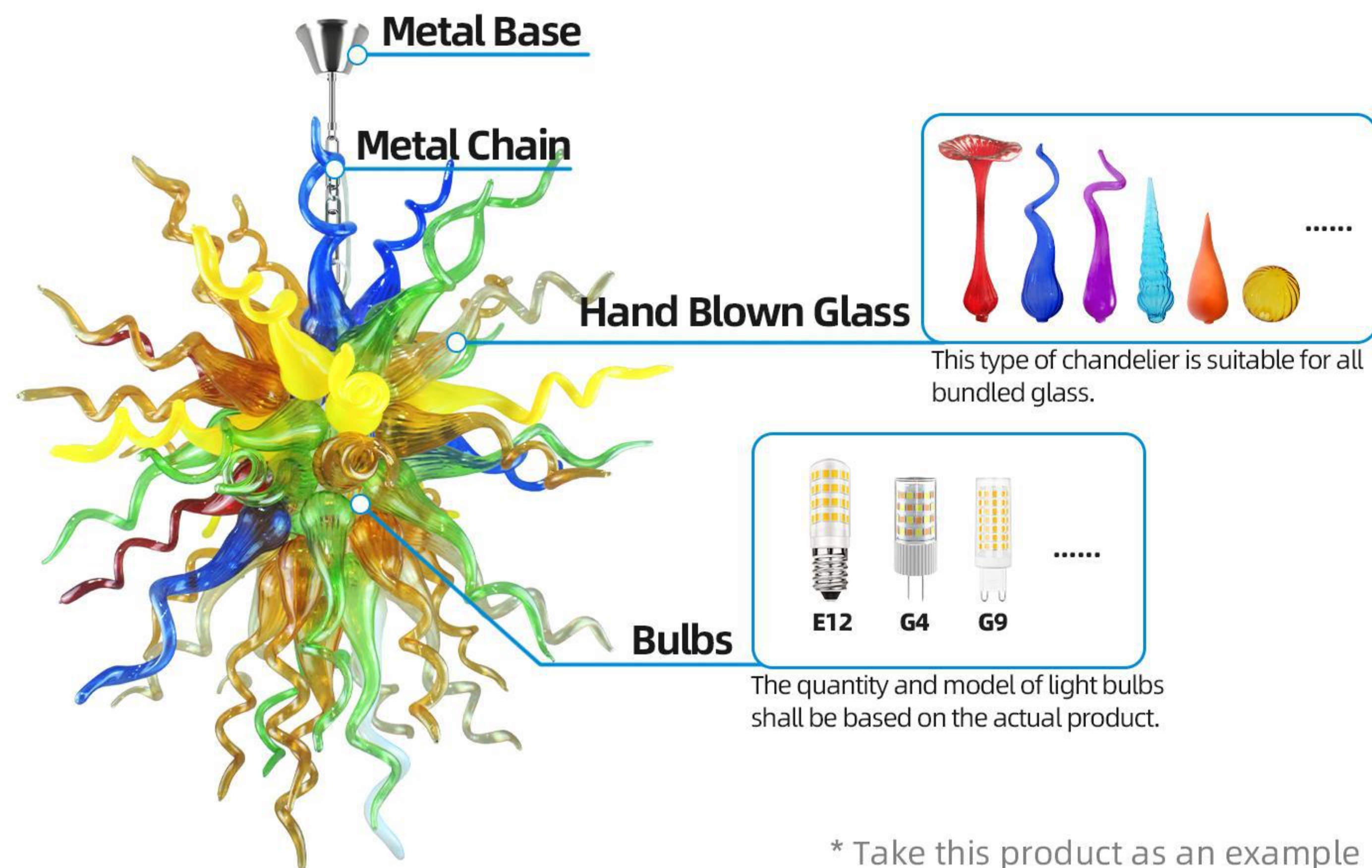

* Take this product as an example

Material	Glass, Metal
Room Type	Bedroom, Living Room, Dining Room, Foyer, Entryway, Staircase, Farmhouse, Hallway, Bathroom
Color Temperature	3000K~6500K
Luminous Flux	1000 Lumen
Light Source Type	LED
Power Source	AC/DC
Color Rendering Index (CRI)	80

3.PRODUCT INSTALLATION

3.1 PRE-INSTALLATION PREPARATION TOOLS



Gloves



Electric drill



Wrench



Ladder

For safer and more efficient installation of chandeliers, you can use additional tools to assist. Please confirm that the power supply is turned off before installation.

3.2 INSTALLATION STEPS

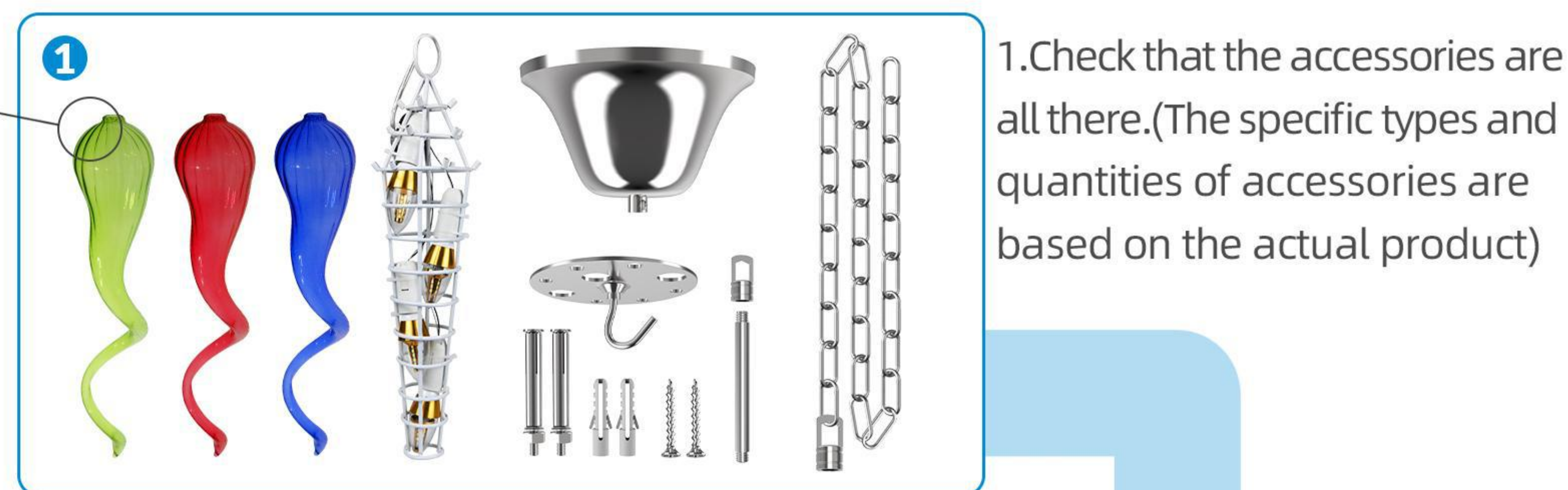

2. Drill holes and install expansion bolts or screws to fix the top plate to the cement ceiling or wooden ceiling.





3. Install glass from bottom to top. If you have more than two types or colors of glass, you can match them according to your preferences.

4. Insert the glass onto the metal frame from bottom to top. If you have more than two types or colors of glass, you can match them according to your preferences.

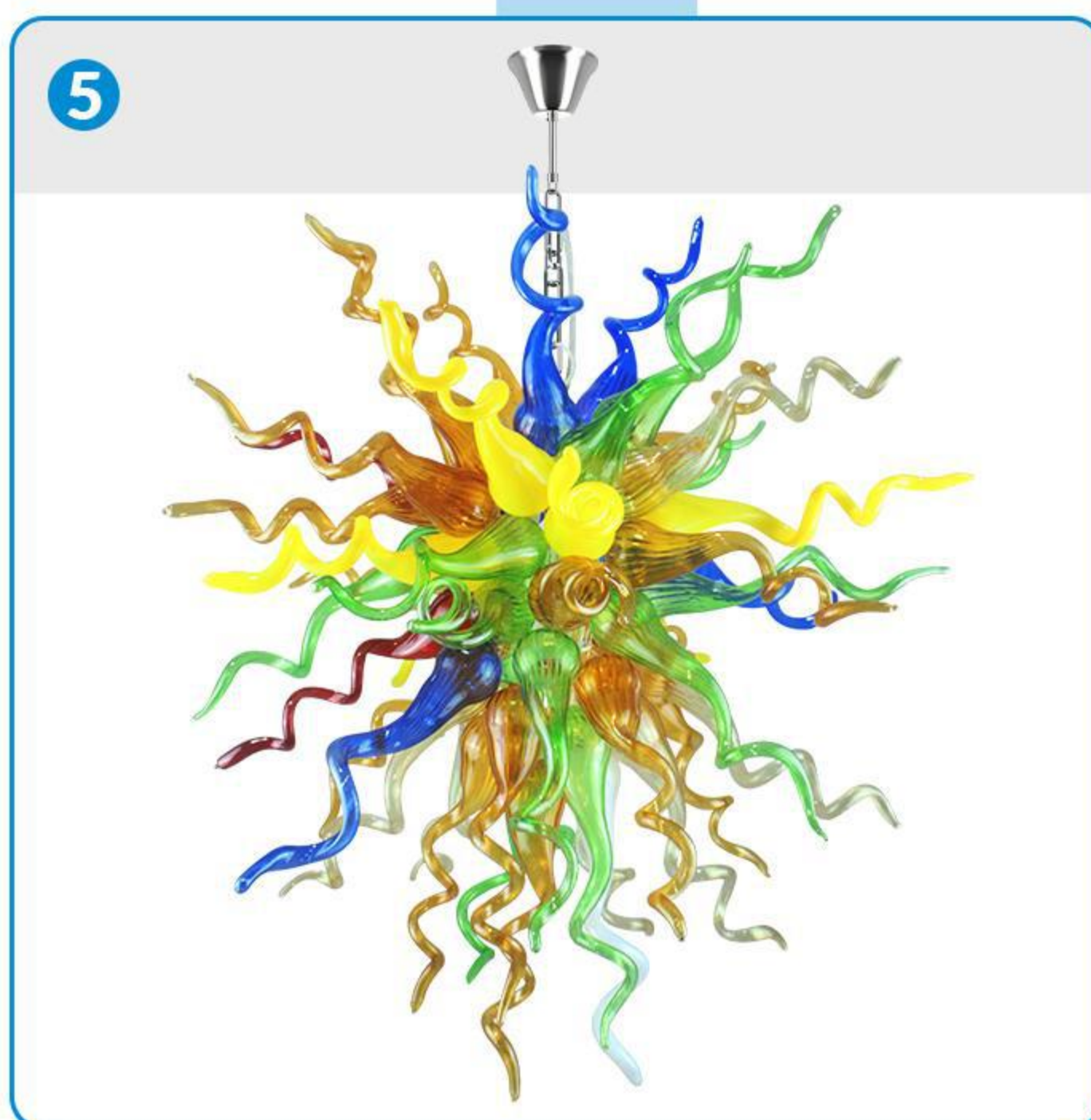



5. Install the remaining glass, complete! Now, turn on the power and enjoy the new light.

4. AFTER-SALE SERVICE

Thank you for purchasing our company's products. We highly value your trust and support in us, and are also delighted to provide you with high-quality products and services. We sincerely thank you again!

Here is some information about chandeliers:

 <p>ABOUT DELIVERY</p>	<p>The chandeliers you ordered comes in one or more packages. For the chandeliers with multiple packages, its light frame and glass rod are packaged and shipped separately. Sometimes due to different express batches, multiple packages cannot be shipped at the same time, so please stay patient. The rest of the packages will usually arrive within a few days of receiving your first package. If you still haven't received the shipment within 5 days, you can contact our customer service to check.</p>
 <p>ABOUT COLOR DIFFERENCE</p>	<p>Product pictures are all taken in kind. However, due to factors such as photography technology, light, and display parameters of electronic equipment, the color of the actual product you receive will be slightly different from the photos. Please refer to the actual product.</p>
 <p>ABOUT AFTER-SALES SERVICE</p>	<p>If you have any questions during receipt or installation, please feel free to contact us on the order details(click "problem with order"). We can provide professional guidance and reshipment of damaged parts due to logistics at any time.</p>

If you have any questions, please feel free to contact us. our customer service team is standby to help you with 24H/7D, we will be offering best solutions regarding any assemble and accessories issues at the very first time.