

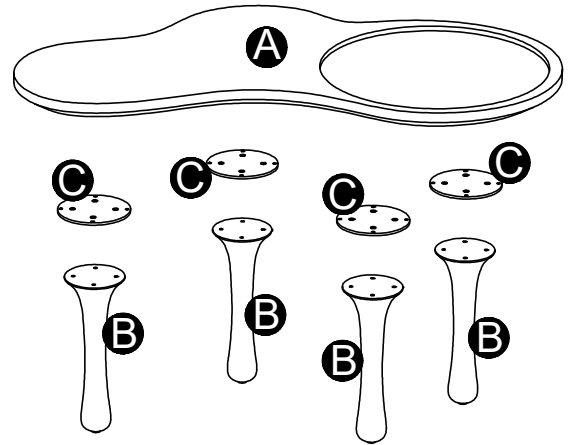

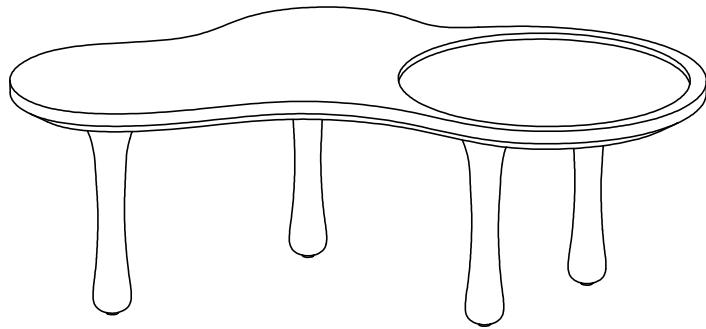

Assembly Instructions

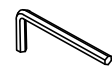

D x16  M6	E x1  M6	F x16  M8	G x1  M8
---	--	---	--

Step1

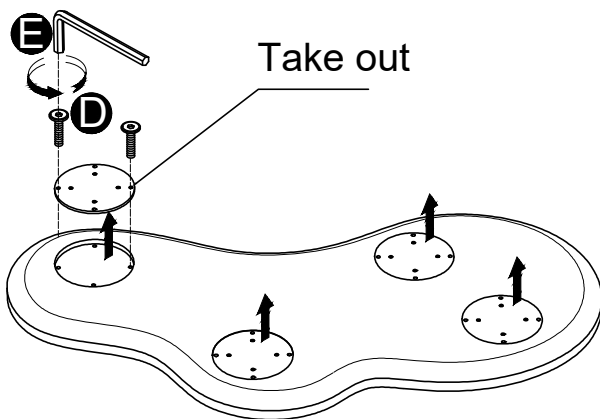

Step2

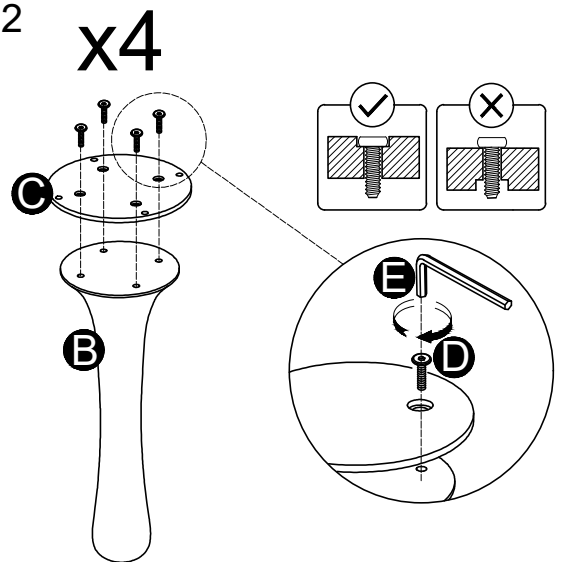

Step3

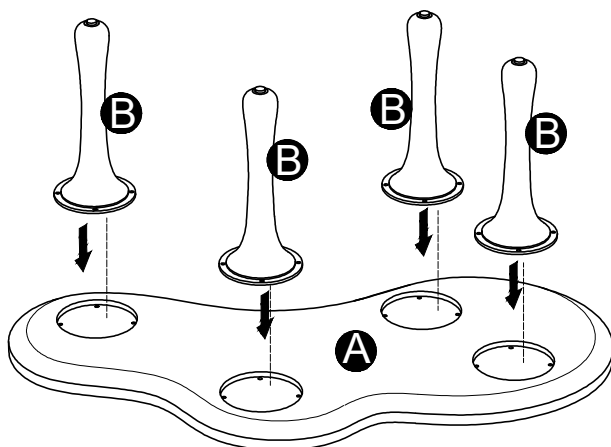

Step4

