

# ASSEMBLY INSTRUCTIONS

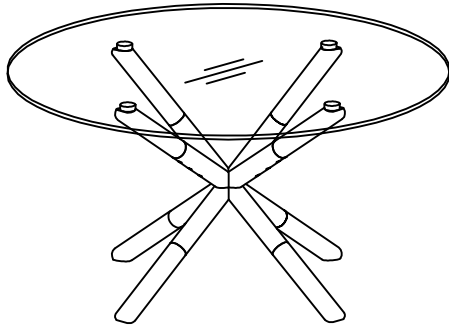

## + Do Not Use PowerTools



## + Suggested Adults

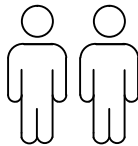

### NOTE:

- 1 Read instructions cover to cover.
- 2 Save all packaging until assembly is completed.

### 1 IMPORTANT SAFETY INFORMATION

**Do not** assemble the product if any of the following parts arrived damaged:

Part # -Table Top

**Tempered Glass Warning:** Should the tempered glass chip at ANY point throughout ownership, please immediately discontinue use of the table to avoid injury.

**CAUTION :** DO NOT place hot objects (100°F or more) directly on the glass surface.

### 2 IMPORTANT ASSEMBLY INFORMATION

**Assembly Step Use Bolt A and Bolt B to connect Part 1 to Part 4.**

## + Parts Included

- ① Lower Leg  
4PCS



- ② Upper Leg  
4PCS

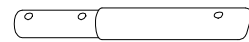

- ③ Connecting Rail  
1PC

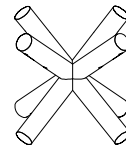

- ④ Glass Top  
1PC

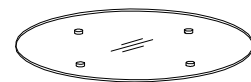

## + Hardware Included

- A Bolt(1/4"\*5/8")  
16 PCS



- B Bolt(1/4"\*1-1/2")  
4 PCS



- C Flat Washer(1/4")  
20 PCS



- D Hex nut(1/4")  
4 PCS



- E Allen wrench(4mm)  
1 PC



- F Socketspanner(10#)  
1 PC



# ASSEMBLY INSTRUCTIONS

①

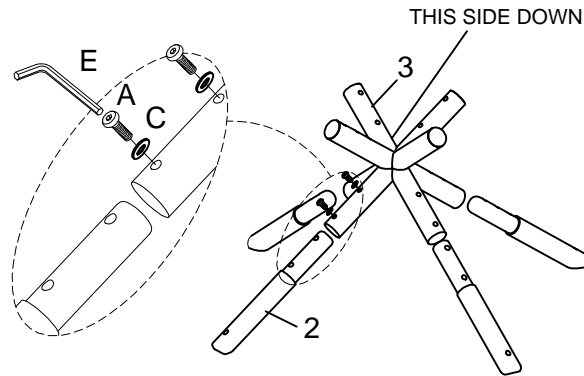

Note: Align the bolts with holes then tighten them at Step 5.

②

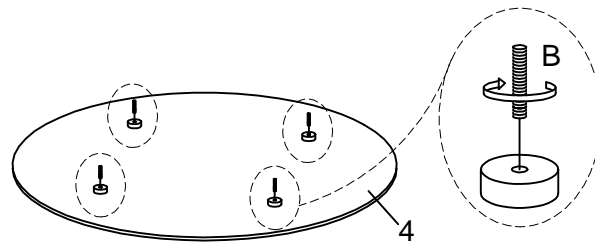

Note: At this stage, tighten all Bolts.

③

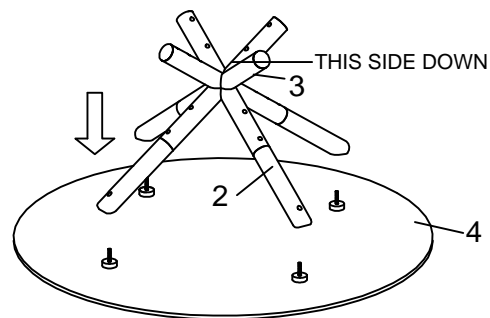

# ASSEMBLY INSTRUCTIONS

④

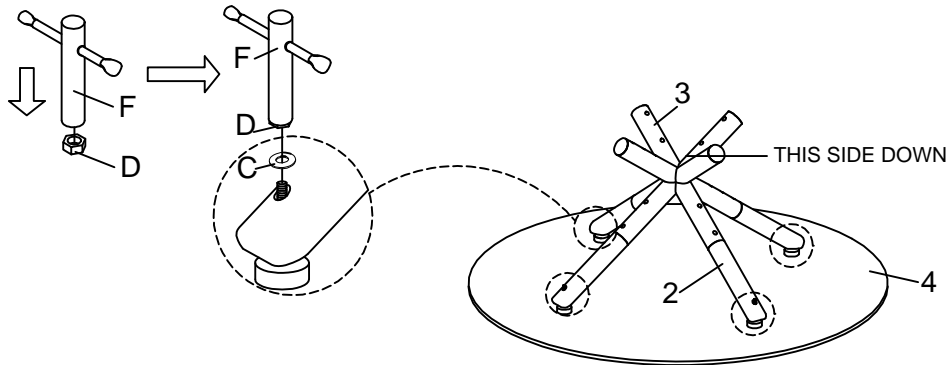

⑤

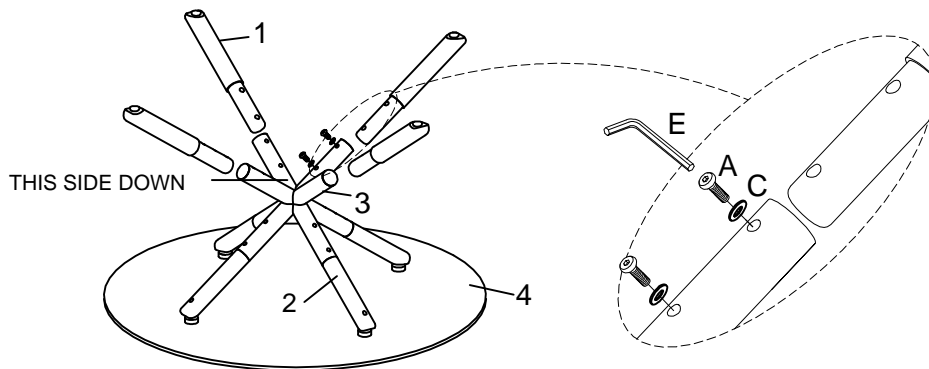

Note: At this stage, pls firstly tighten the screws at this step, then fully tighten all screws.

⑥

