

WOODEN PILLAR BASE
DINING TABLE
ASSEMBLY GUIDE

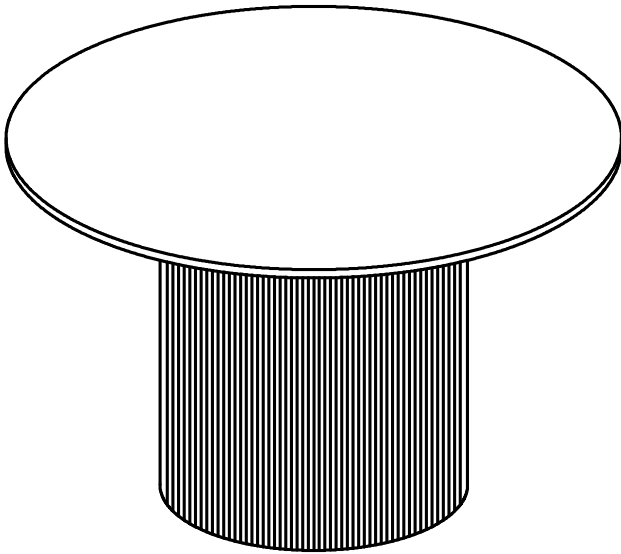

Important - Please read these instructions fully before starting assembly



**SAFETY AND
CARE ADVICE**



NO POWER TOOLS

SAFETY AND CARE ADVICE

- Check you have all the components and tools listed.
- Remove all fittings from the plastic bags and separate them into their groups.
- We do not recommend the use of power drills/drivers for inserting screws, as this could damage the unit. Only use hand screwdrivers and Allen keys.
- Keep children and animals away from the work area, small parts could cause choking if swallowed.
- Make sure you have enough space to lay out the parts before starting.
- Assemble the item as close to its final position (in the same room) as possible.
- Do not overtighten the nuts to avoid causing damage to the threads.
- Only clean using a damp cloth and mild detergent, do not use bleach or abrasive cleaners.
- From time to time check that there are no loose screws on this unit.
- This product should not be discarded with household waste. Take to your local authority waste disposal centre.

IMPORTANT INFORMATION



30 MINUTE
BUILD





TWO
PERSON







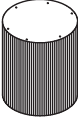

MAXIMUM
CAPACITY 80Kg

PLEASE CHECK CAREFULLY AND MAKE SURE YOU HAVE ALL FITTINGS AND TOOLS LISTED BELOW BEFORE YOU START.

PARTS LIST:

DESCRIPTION	PART NAME	Q'ty(PCS)
①		1
②		1
③		1

HARDWARE LIST:

						
M8x30	M8x40	M8	Ø8x18	8#		5#
A	B	C	D	E	F	G
6PCS	6PCS	6PCS	12PCS	1PC	12PCS	1PC

NOTE: The quantities above are the correct amount to complete the assembly. In some cases more fittings may be supplied than are required.

STEP 1

Use a clean, flat, soft surface to avoid any bumps or scratches. Unpack and place pillar [3] with its bottom facing up.

Peel off the backing of a felt pad [F] and paste it onto the bottom of pillar base [3]. Repeat this step with the remaining felt pads [E].

Note: Position the felt pads as close to the edge as possible.

With help, carefully turn the pillar base [3] upright.

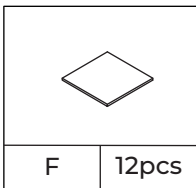
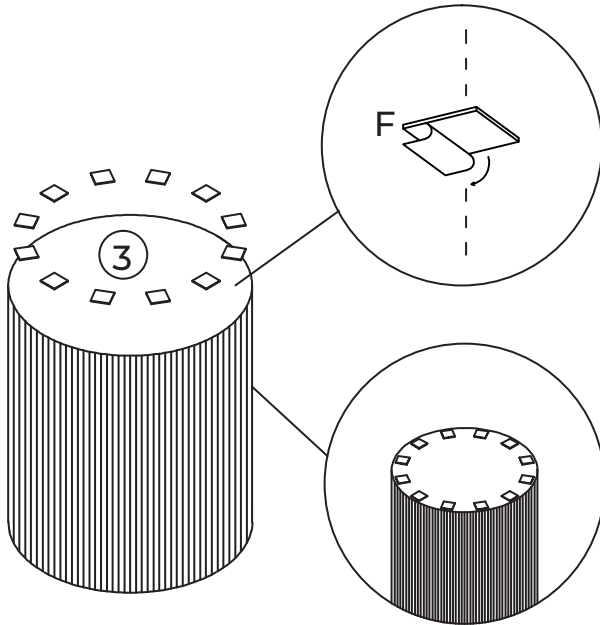

STEP 2

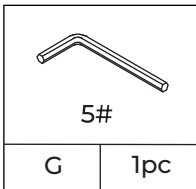
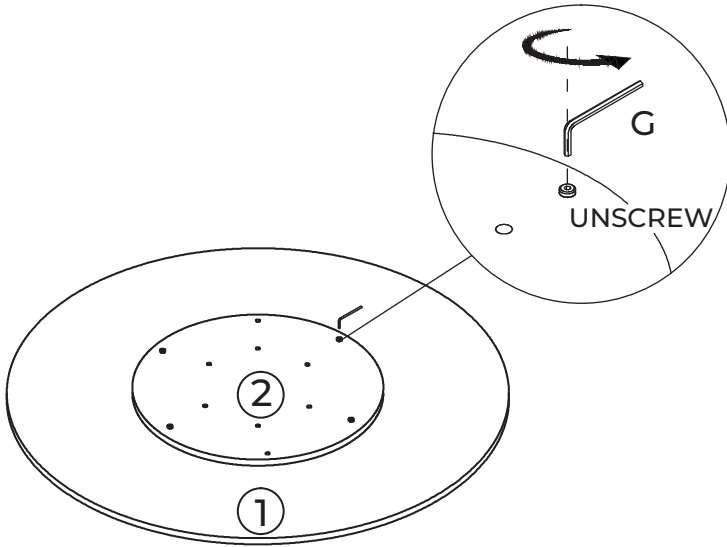

Carefully and with help, unpack the table top [1] and place the table top upside down on the soft surface. Use Allen Key [G] to unscrew the bolts on the base plate [2]. Separate base plate [2] from table top [1]. Discard the bolts, as these are only used to secure the parts for transporting and are no longer required.

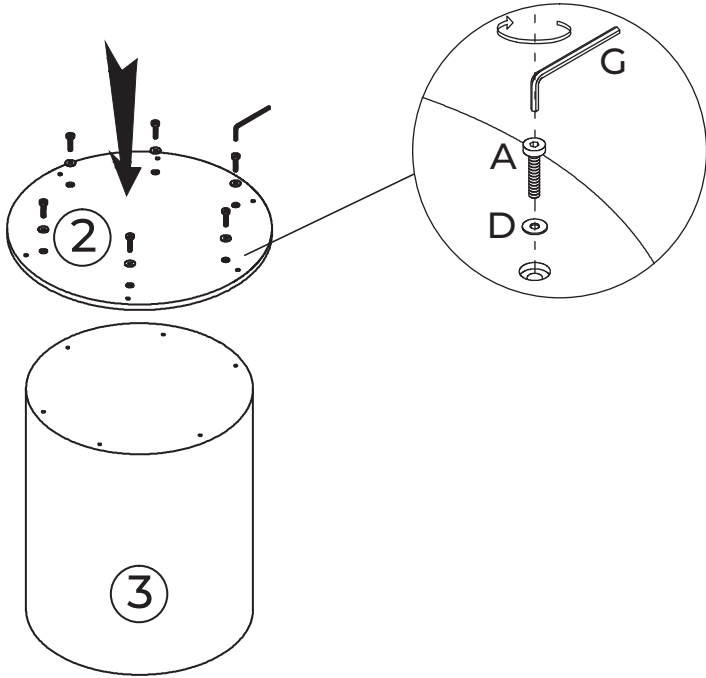

STEP 3

With help, carefully place base plate [2] onto pillar base [3], making sure the holes on base plate [2] and pillar base [3] are aligned. Attach the base plate [2] to pillar base [3] with 6 x bolts [A] and 6 x washers [D]. Fully tighten all bolts using Allen key [G].

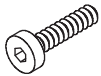

					
M8x30	Ø8x18	5#			
A	6pcs	D	6pcs	G	1pc

STEP 4

Screw 6 x Threaded Bolts [B] with thread into the Top [1].

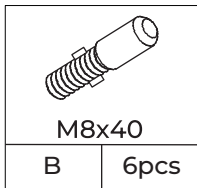
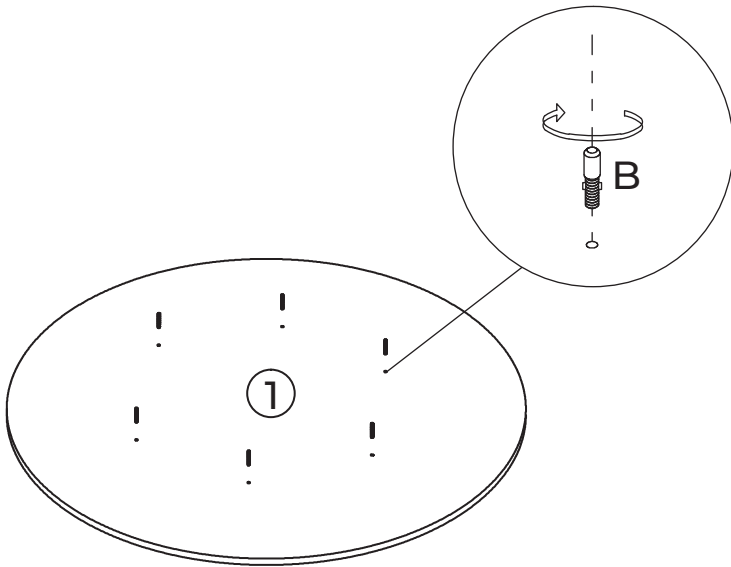

M8x40



B

6pcs

STEP 5

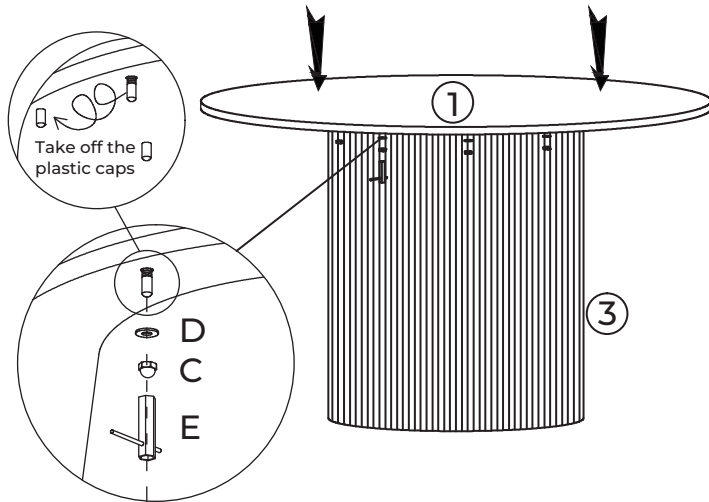
Carefully and with help, place table top [1] onto base plate [2], making sure bolts [B] are inserted into the holes on base plate [2]. Remove the plastic caps of Bolts [B]. Secure table top [1] to base plate [2] with 6 x nuts [C] and 6 x washers [D]. Fully tighten all nuts using spanner [E].

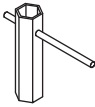

					
M8		Ø8x18		8#	
C	6pcs	D	6pcs	E	1pc

STEP 6

Your dining table is complete and ready to use.

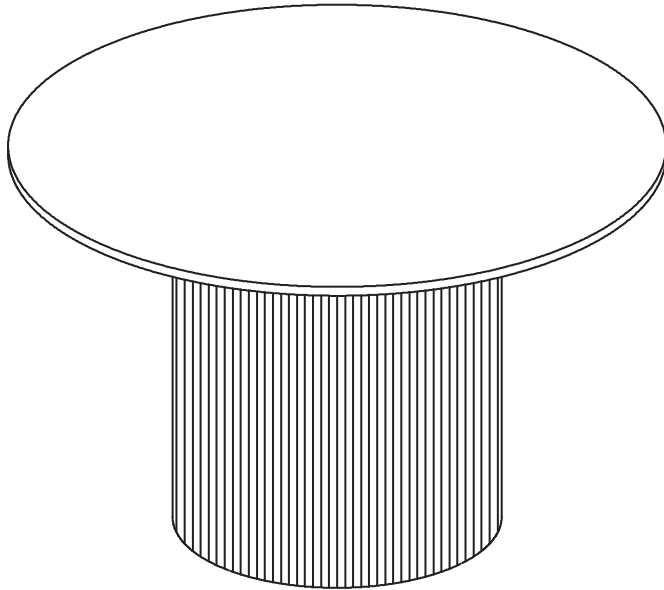



OUR 2 YEAR* GUARANTEE

our products come with a 2 year guarantee
to give you peace of mind shopping

*excludes some garden furniture items
which have a 1 year guarantee



WHAT THE GUARANTEE COVERS



PRE-INSERTED FIXINGS
e.g. lose metal threads



FAULTY JOINTS
e.g. legs bending



EXTERNAL FIXING FAULTS
e.g. bonding/glue



STRUCTURAL INTEGRITY
e.g. the frame of the
product