

N130P327074N

N1309327075N

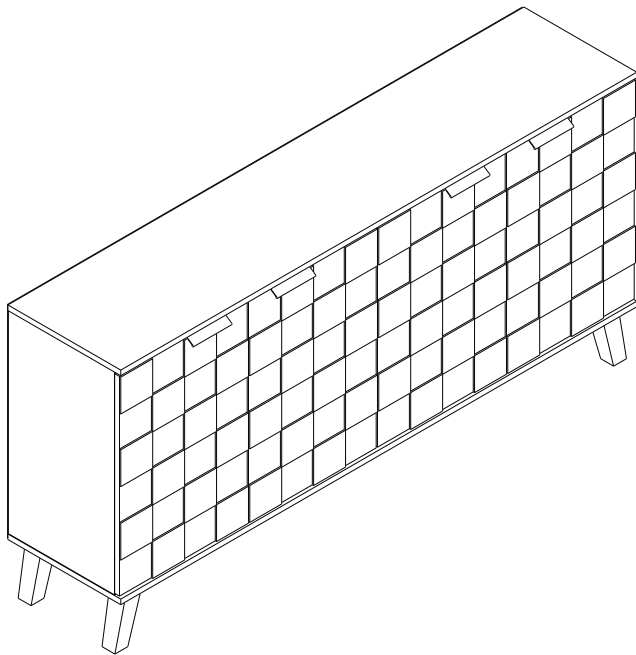

Please check that you have all the parts listed before you start assembling, if you do find that something is missing, do not continue assembly, please contact us immediately.

Note: Please do not fully tighten all the screws until the overall frame is built

**D** Gebrauchsanweisung

**NL** Gebruiksrichtlijnen

**IT** Istruzioni per l'uso

**CZ** Pokyny k použití

**HU** Használati útmutató

**PT** Instruções de utilização

**SK** Pokyny k použitiu

**GB** Instructions for use

**FR** Instructions d'utilisation

**PL** Instrukcja obsługi

**ES** Instrucciones de empleo

**RO** Instrucțiuni de folosire

**RU** Инструкция по монтажу

**TR** Kullanım talimatları

This set will be shipped by 2 boxes and they may arrive on different days. If both packages arrived but parts missing, please contact customer service.

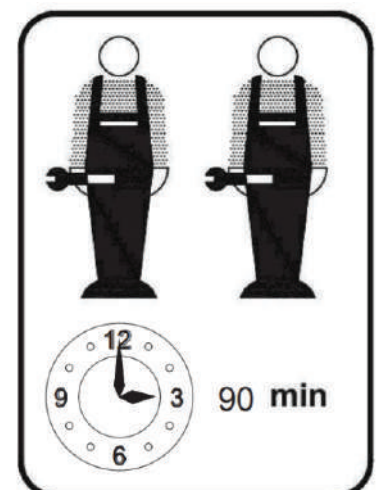

REV1, 25/06/2025



**EN**

**Warning:** The maximum load-bearing capacity of this furniture is:  
50 kg, please do not overload!



[DE]

**Warnung:** Lesen Sie die Anleitung vor dem Zusammenbau bitte vollständig durch. Überprüfen Sie, ob Sie alle auf den Seiten aufgeführten Komponenten und Werkzeuge haben.

**Warnung:** Legen Sie alle Teile auf eine ebene Fläche. Legen Sie eine weiche Decke oder Ähnliches darunter, um sie vor Kratzern oder Flecken zu schützen. Vermeiden Sie es, Komponenten über den Boden zu ziehen oder zu schieben.

**Warnung:** Überprüfen Sie regelmäßig alle Beschläge und Befestigungen, um sicherzustellen, dass sie sicher sind und um Unfälle zu vermeiden. Wenn Teile fehlen, kaputt, beschädigt oder abgenutzt sind, verwenden Sie das Produkt nicht weiter, bis es mit vom Hersteller autorisierten Teilen repariert wurde.

**Warnung:** Lassen Sie Kinder nicht auf die Möbel klettern, da dies zum Umkippen und zu schweren Verletzungen führen kann. Bauen Sie die Möbel außerhalb der Reichweite von Kindern zusammen.

**Warnung:** Stellen Sie die Möbel nicht in die Nähe von Feuerquellen oder heißen Gegenständen, um Brandgefahr zu vermeiden.

**Warnung:** Reinigen Sie die Möbel mit einem feuchten Tuch oder Alkohol. Verwenden Sie keine Reinigungsmittel mit ätzenden Chemikalien.

**Warnung:** Dieses Produkt ist mit einer Kippschutzvorrichtung ausgestattet. Bitte installieren Sie diese Vorrichtung unbedingt, um unnötige Verletzungen durch Umkippen zu vermeiden.

[EN]

**Warning:** Please read instructions fully before starting assembly. Check you have all the components and tools listed on pages.

**Warning:** Please place all parts on a flat surface. Place a soft blanket or similar underneath to protect against scratches or stains. Avoid dragging or sliding components across the floor.

**Warning:** Regularly check all fittings and fastenings to ensure they are secure and to prevent accidents. If any parts are missing, broken, damaged, or worn, discontinue use of the product until repairs have been made using factory authorized parts.

**Warning:** Do not allow children to climb on the furniture as this may result in tipping and serious personal injury. Assemble the furniture away from the reach of children.

**Warning:** Do not place furniture close to fire sources or high-temperature objects to avoid the risk of fire.

**Warning:** Clean furniture with a damp cloth or alcohol, avoid using cleaning agents containing corrosive chemicals.

**Warning:** This product is equipped with an anti-tilt device. Please be sure to install this device to prevent unnecessary injuries caused by tipping.

[FR]

**Avertissement :** Veuillez lire entièrement les instructions avant de commencer l'assemblage. Vérifiez que vous disposez de tous les composants et outils répertoriés sur les pages.

**Avertissement :** Veuillez placer toutes les pièces sur une surface plane. Placez une couverture douce ou similaire en dessous pour les protéger des rayures ou des taches. Évitez de faire glisser les composants sur le sol.

**Avertissement :** Vérifiez régulièrement tous les raccords et fixations pour vous assurer qu'ils sont bien fixés et pour éviter les accidents. Si des pièces manquent, sont cassées, endommagées ou usées, cessez d'utiliser le produit jusqu'à ce que des réparations aient été effectuées à l'aide de pièces autorisées par l'usine.

**Avertissement :** Ne laissez pas les enfants grimper sur les meubles car cela pourrait entraîner un basculement et des blessures graves. Assemblez les meubles hors de portée des enfants.

**Avertissement :** Ne placez pas les meubles à proximité de sources de feu ou d'objets à haute température pour éviter tout risque d'incendie.



**Avertissement** : Nettoyez les meubles avec un chiffon humide ou de l'alcool, évitez d'utiliser des produits de nettoyage contenant des produits chimiques corrosifs.

**Avertissement** : Ce produit est équipé d'un dispositif anti-basculement. Assurez-vous d'installer ce dispositif pour éviter les blessures inutiles causées par un basculement.

[IT]

**Attenzione**: leggere attentamente le istruzioni prima di iniziare il montaggio. Verificare di avere tutti i componenti e gli strumenti elencati nelle pagine.

**Attenzione**: posizionare tutte le parti su una superficie piana. Posizionare una coperta morbida o simile sotto per proteggere da graffi o macchie. Evitare di trascinare o far scivolare i componenti sul pavimento.

**Attenzione**: controllare regolarmente tutti i raccordi e i dispositivi di fissaggio per assicurarsi che siano sicuri e per prevenire incidenti. Se alcune parti sono mancanti, rotte, danneggiate o usurate, interrompere l'uso del prodotto fino a quando non siano state eseguite le riparazioni utilizzando parti autorizzate dalla fabbrica.

**Attenzione**: non consentire ai bambini di arrampicarsi sui mobili poiché ciò potrebbe causare ribaltamenti e gravi lesioni personali. Montare i mobili lontano dalla portata dei bambini.

**Attenzione**: non posizionare i mobili vicino a fonti di fuoco o oggetti ad alta temperatura per evitare il rischio di incendio.

**Attenzione**: pulire i mobili con un panno umido o alcol, evitare di utilizzare detergenti contenenti sostanze chimiche corrosive.

**Attenzione**: questo prodotto è dotato di un dispositivo antiribaltamento. Assicurarsi di installare questo dispositivo per prevenire lesioni inutili causate dal ribaltamento.

[ES]

**Advertencia**: Lea las instrucciones completamente antes de comenzar el montaje. Compruebe que tiene todos los componentes y herramientas que se enumeran en las páginas.

**Advertencia**: Coloque todas las piezas sobre una superficie plana. Coloque una manta suave o algo similar debajo para protegerlas de rayones o manchas. Evite arrastrar o deslizar los componentes por el piso.

**Advertencia**: Verifique regularmente todos los accesorios y fijaciones para asegurarse de que estén seguros y evitar accidentes. Si falta alguna pieza, está rota, dañada o desgastada, deje de usar el producto hasta que se hayan realizado las reparaciones con piezas autorizadas de fábrica.

**Advertencia**: No permita que los niños se suban a los muebles, ya que esto puede provocar que se vuelquen y lesiones personales graves. Monte los muebles fuera del alcance de los niños.

**Advertencia**: No coloque los muebles cerca de fuentes de fuego u objetos de alta temperatura para evitar el riesgo de incendio.

**Advertencia**: Limpie los muebles con un paño húmedo o alcohol, evite usar agentes de limpieza que contengan químicos corrosivos.

**Advertencia**: Este producto está equipado con un dispositivo antivuelco. Asegúrese de instalar este dispositivo para evitar lesiones innecesarias causadas por vuelcos.

<b>Importer</b>	COMHARBOR LIMITED
<b>Adresse</b>	Unit C, Swift Point, Cosford Lane, Rugby, CV21 1PY, GB
<b>Email/URL</b>	harborcomhar@gmail.com
<b>Manufacturer</b>	Delano Furniture Industries (M) Sdn Bhd
<b>Adresse</b>	Furniture Village, 1406, Lorong Bakap 5, Jalan Sungai Baong, Sungai Bakap, 14200, Penang
<b>Email/URL</b>	<a href="https://www.delanofurnitures.com.my">https://www.delanofurnitures.com.my</a>
<b>Product Identification</b>	N130P327074N / N130P327075N
<b>Made in</b>	MALAYSIA



COMHARBOR LIMITED  
Unit C, Swift Point, Cosford Lane,  
Rugby, CV21 1PY, GB  
harborcomhar@gmail.com

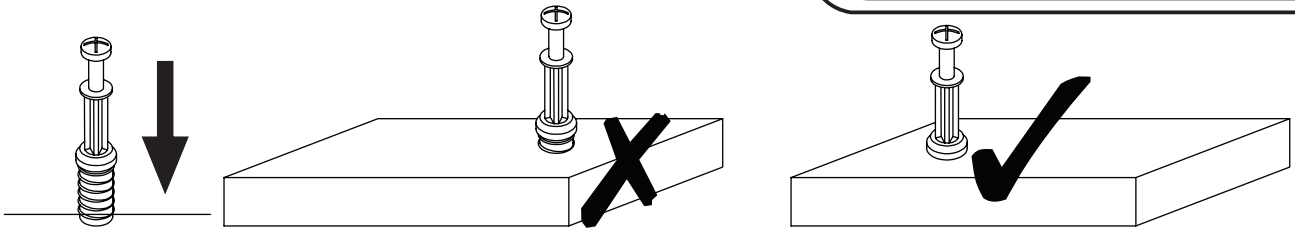

**EN\_QUICKFIT:** Tighten quickfit until shoulder is flush with panel. Do not overtighten or undertighten.

**FR\_RACCORD RAPIDE:** Faites serrer le raccord rapide jusqu'à ce que l'épaulement soit parfaitement encastré dans le panneau. Il ne faut ni trop serrer ni insuffisamment serrer.

**ES\_QUICKFIT:** Apriete quickfit hasta que el hombro se descargue con el panel. NO lo sobreapriete ni lo apriete poco.

**DE\_QUICKFIT:** Ziehen Sie den Quickfit fest, bis die Schulter mit der Platte bündig ist. Bitte nicht zu fest oder zu schwach anziehen.

**IT\_MONTAGGIO RAPIDO:** Stringere il montaggio rapido fino a quando la spalla è a filo con il pannello, non stringere troppo o troppo poco.

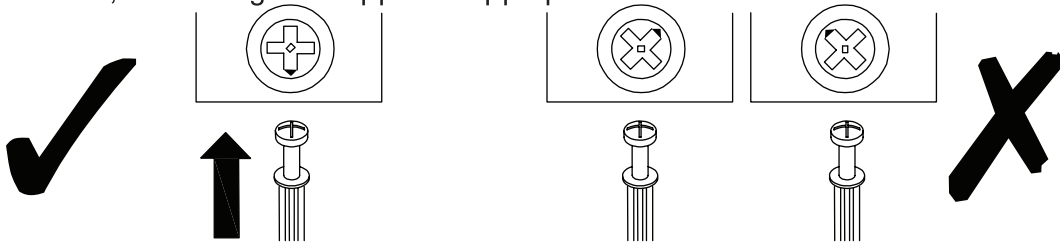

**EN\_CAM LOCK:** When fitting cam lock, ensure starting position is correct before you insert connecting quickfit.

**FR\_SERRURE BATTEUSE:** Avant d'insérer la serrure batteuse, veillez à la bonne orientation avant d'insérer le raccord rapide.

**ES\_CIERRE DE LA CÁMARA:** Cuando instale el cierre de la cámara, asegúrese de que la posición de inicio es correcta antes de que inserte el quickfit conector.

**DE\_CAM-LOCK:** Achten Sie bei der Montage des Cam-Locks auf die richtige Ausgangsposition, bevor Sie den Quickfit einsetzen.

**IT\_BLOCCAGGIO A CAMMA:** Quando si monta il bloccaggio a camma, assicurarsi che la posizione iniziale sia corretta prima di inserire il montaggio rapido di collegamento.

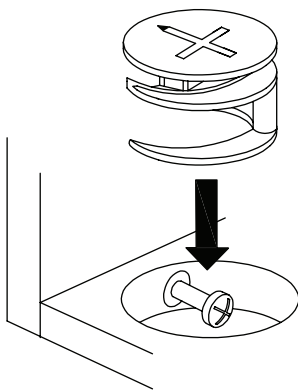

**EN\_Quickfit head** should be in the centre of the cam lock when the two panels are joined.

Cam lock should be inserted before quickfit.

**FR\_**Lorsque les deux panneaux sont assemblés, la tête du raccord rapide doit reposer au centre de la serrure batteuse. Il faut insérer la serrure batteuse avant le raccord rapide.

**ES\_**El cabezal del quickfit debe estar en el centro del cierre de la cámara cuando se unan los dos paneles.

Se debe insertar el cierre de la cámara antes que el quickfit.

**DE\_**Der Quickfit-Kopf sollte sich in der Mitte des Cam-Locks befinden, wenn die beiden Platten zusammengefügt sind. Der Cam-Lock sollte vor dem Quickfit eingesetzt werden.

**IT\_**La testa del montaggio rapido deve trovarsi al centro del bloccaggio a camma quando i due pannelli sono uniti.

Il Bloccaggio a Camma deve essere inserito prima del montaggio rapido.

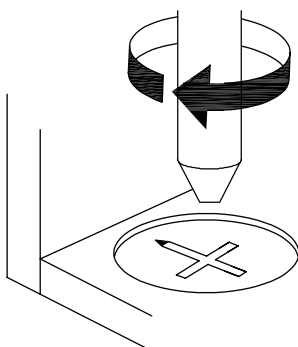

**EN\_**Turn cam lock clockwise to tighten.

**FR\_**Faites tourner la serrure batteuse dans le sens des aiguilles d'une montre pour la resserrer.

**ES\_**Gire el cierre de la cámara en sentido horario para apretarlo.

**DE\_**Drehen Sie den Cam-Lock im Uhrzeigersinn, um ihn festzuziehen.

**IT\_**Ruotare il bloccaggio a camma in senso orario per stringere.

**EN** It may be necessary to adjust the hinges so that the doors align. Use the instructions below as a guide.

**FR** Il est parfois nécessaire d'ajuster les charnières pour un meilleur alignement des portes. Servez-vous des instructions ci-dessous comme guide.

**ES** Puede que sea necesario ajustar los quicios de forma que se alineen las puertas. Use las instrucciones que aparecen debajo como guía.

**DE** Möglicherweise müssen Sie die Scharniere so einstellen, dass die Türen ausgerichtet sind. Verwenden Sie die nachstehenden Anweisungen als Leitfaden.

**IT** Potrebbe essere necessario regolare le cerniere in modo che le porte siano allineate. Per fare ciò attenersi alle istruzioni sottostanti.

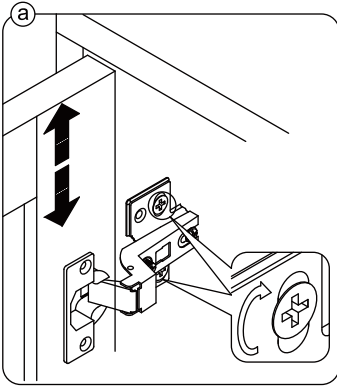

**EN** To adjust the door vertically loosen the screw as shown and move up and down as needed.

**FR** Si vous souhaitez régler la porte **verticalement**, desserrez la vis comme indiqué et déplacez la porte de haut en bas selon les besoins.

**ES** Para ajustar la puerta **verticalmente** afloje el tornillo tal y como se muestra y muévalo hacia arriba o hacia abajo según sea necesario.

**DE** Um die Tür **vertikal** auszurichten, lösen Sie die Schraube wie abgebildet und bewegen Sie sie nach Bedarf nach oben oder nach unten.

**IT** Per allineare la porta **verticalmente** allentare la vite come mostrato e spostarla in alto o in basso secondo necessità.

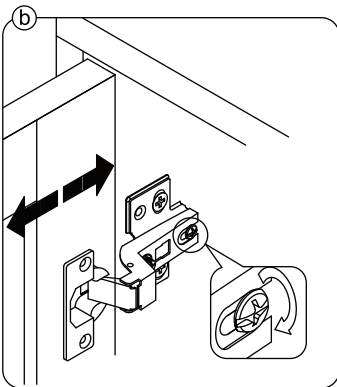

**EN** To adjust the gap from the door to the main frame turn the screw clockwise or anti-clockwise as needed.

**FR** Si vous souhaitez ajuster l'**écart** entre la porte et le cadre principal, tournez la vis dans le sens des aiguilles d'une montre ou dans le sens inverse, si nécessaire.

**ES** Para ajustar el **espacio** desde la puerta al marco principal, gire el tornillo en sentido horario o antihorario, según se necesite.

**DE** Um den **Abstand** von der Tür zum Hauptrahmen auszurichten, drehen Sie die Schraube je nach Bedarf im oder gegen den Uhrzeigersinn.

**IT** Per regolare lo **spazio** tra la porta e il telaio principale, avvitare o svitare la vite secondo necessità.

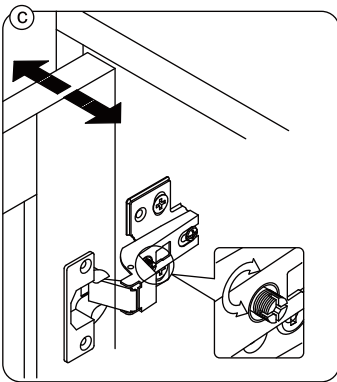

**EN** To adjust the door laterally adjust the screw as shown by turning clockwise or anti-clockwise.

**FR** Si vous souhaitez ajuster la porte **latéralement**, ajustez la vis comme indiqué en tournant dans le sens des aiguilles d'une montre ou dans le sens inverse des aiguilles d'une montre.

**ES** Para ajustar la puerta **lateralmente** ajuste el tornillo tal y como se muestra girándolo en sentido horario y antihorario.

**DE** Um die Tür **seitlich** auszurichten, stellen Sie bitte die Schraube wie abgebildet durch Drehen im oder gegen den Uhrzeigersinn ein.

**IT** Per allineare la porta **lateralmente** regolare la vite come mostrato, avvitandola o svitandola.

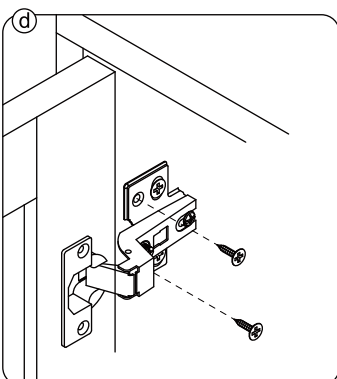

**EN** Please fix other screws

**FR** Merci de serrer les autres vis.

**ES** Fije los demás tornillos

**DE** Befestigen Sie bitte die anderen Schrauben

**IT** Fissare le altre viti

## Part List N130P327074N

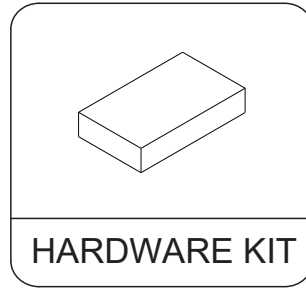
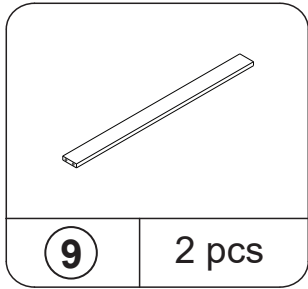
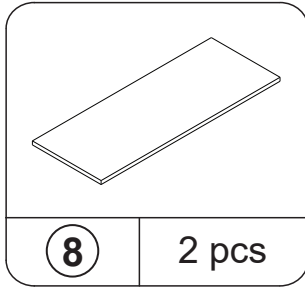
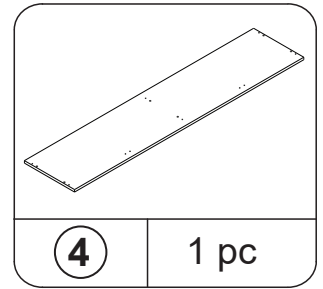
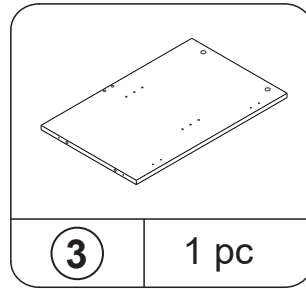
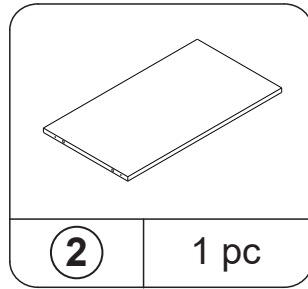
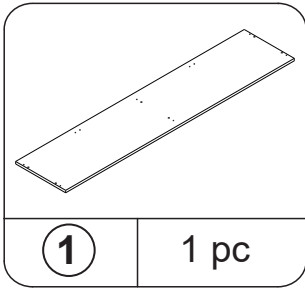



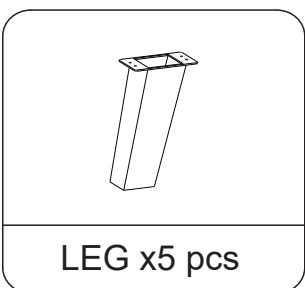
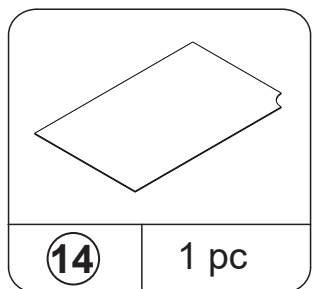
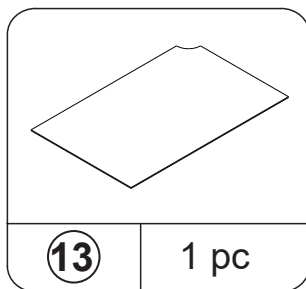
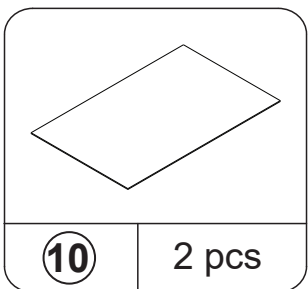
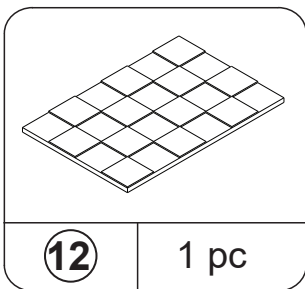
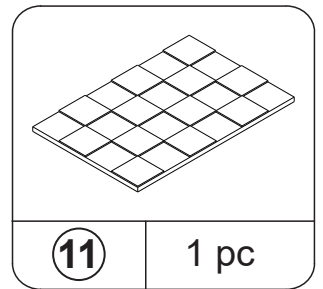
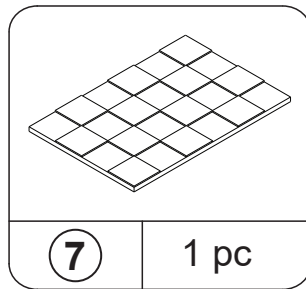
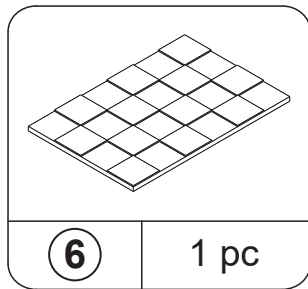
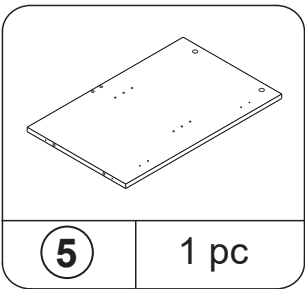



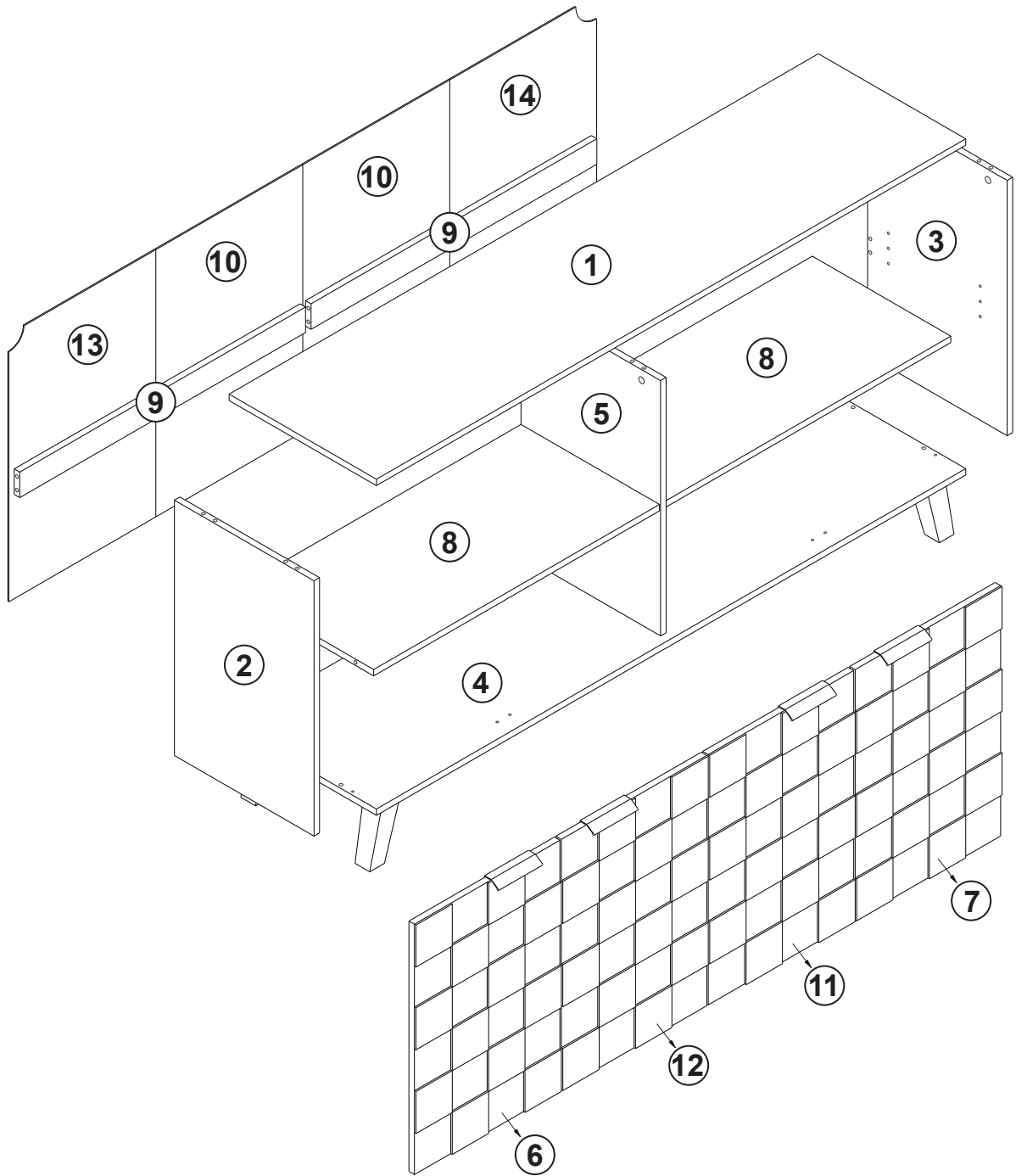

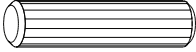
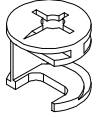
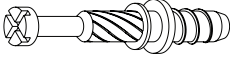
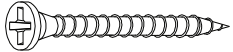
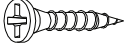
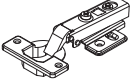

## Part List N1309327075N

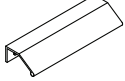

# Exploded View

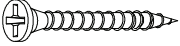

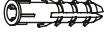
# Hardware List N130P327074N

<p>Dowels M8 x 30mm</p>  <p><b>A</b> 16 pcs</p>	 <p><b>B</b> 6 pcs</p>	<p>M5 x 9mm</p>  <p><b>C</b> 6 pcs</p>	<p>Screw M4 x 45mm</p>  <p><b>D</b> 6 pcs</p>
<p>Screw M3.5 x 16mm</p>  <p><b>E</b> 86 pcs</p>	 <p><b>F</b> 4 pcs</p>	 <p><b>G</b> 4 pcs</p>	<p>Nails 3/4"</p>  <p><b>H</b> 50 pcs</p>
 <p><b>J</b> 4 pcs</p>	<p>5mm x 15mm</p>  <p><b>K</b> 8 pcs</p>	 <p><b>L</b> 4 pcs</p>	<p>Dowels M8 x 50mm</p>  <p><b>M</b> 2 pcs</p>
<p>Screw M4 x 38mm</p>  <p><b>N</b> 2 pcs</p>	 <p><b>O</b> 2 pcs</p>	 <p><b>P</b> 2 pcs</p>	<p>Washer M4</p>  <p><b>Q</b> 2 pcs</p>

## Tools Required (Not Included)

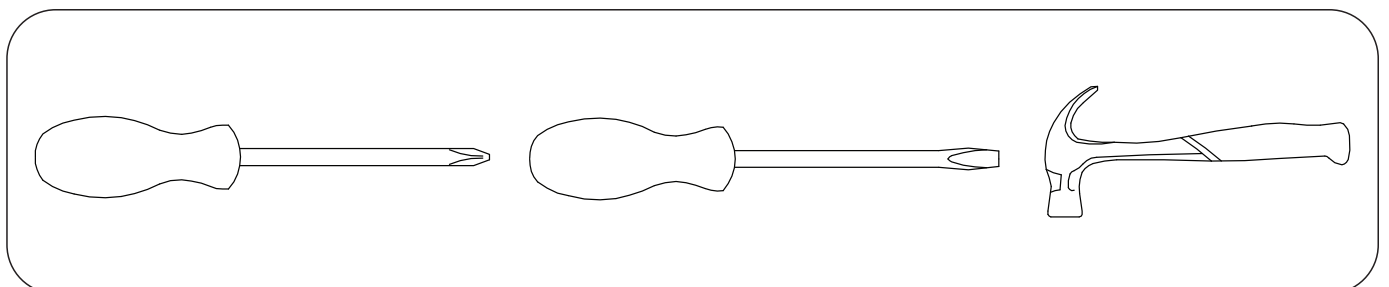

# Hardware List

## N1309327075N

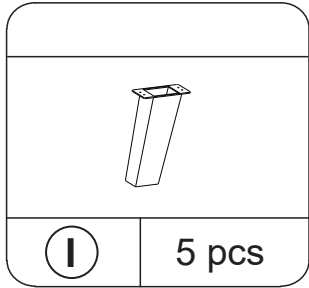

### Tools Required (Not Included)

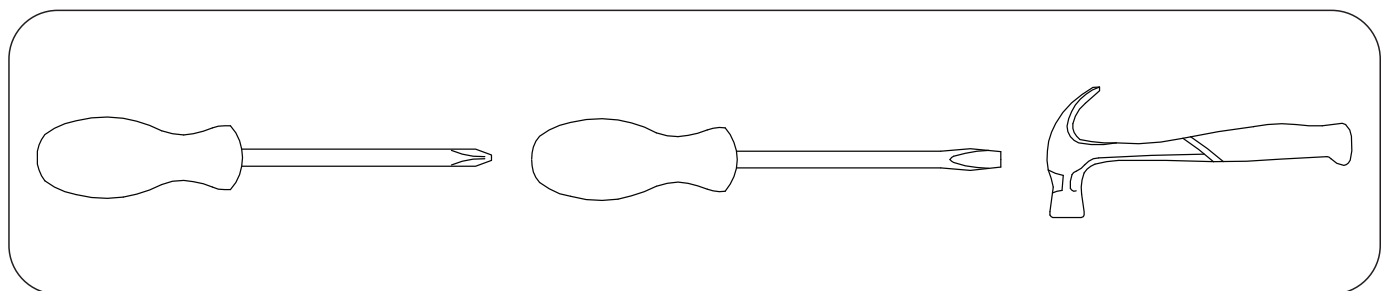

1

A 16 pcs

C 6 pcs

E 4 pcs

L 4 pcs

M 2 pcs

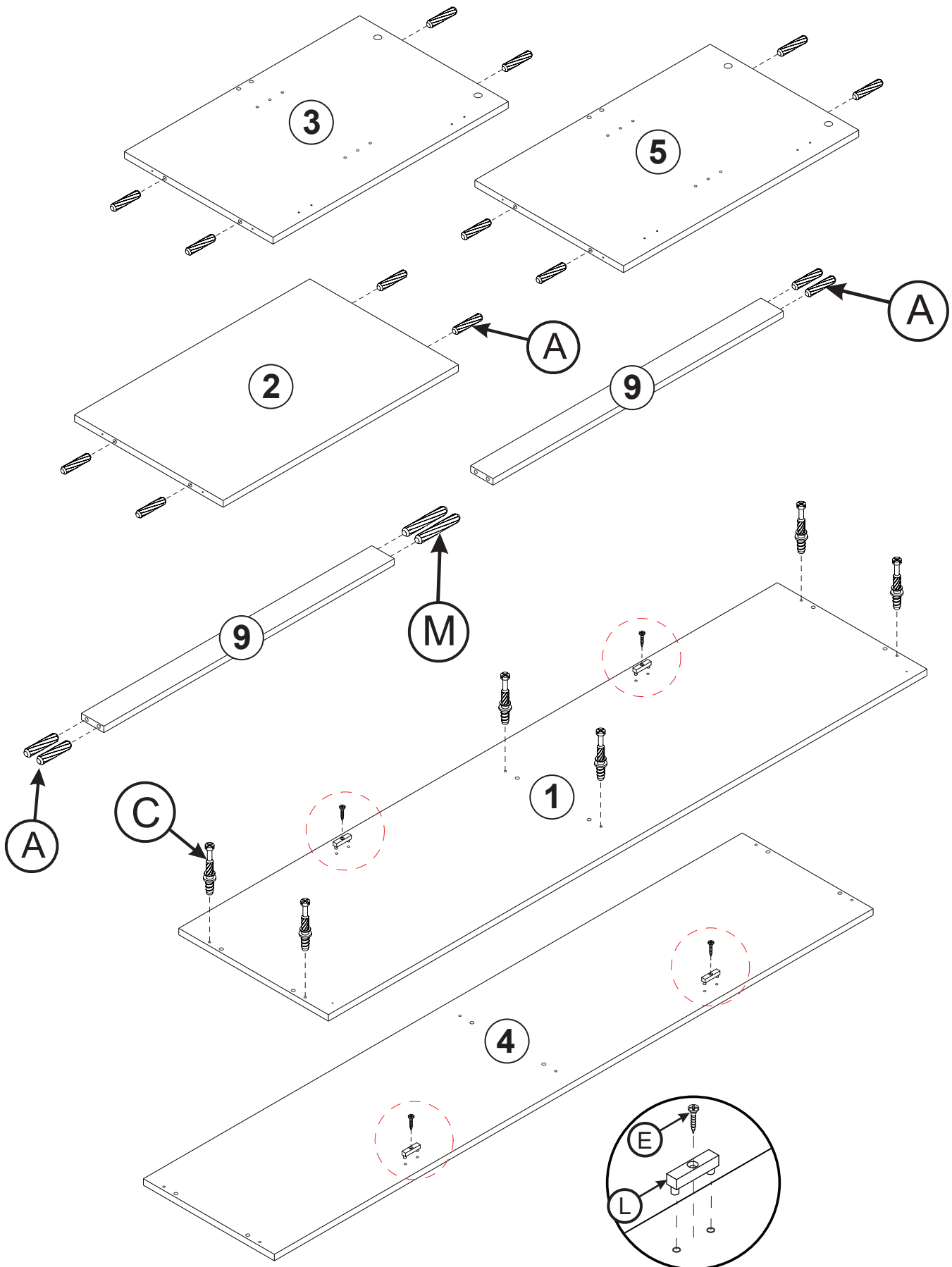

2

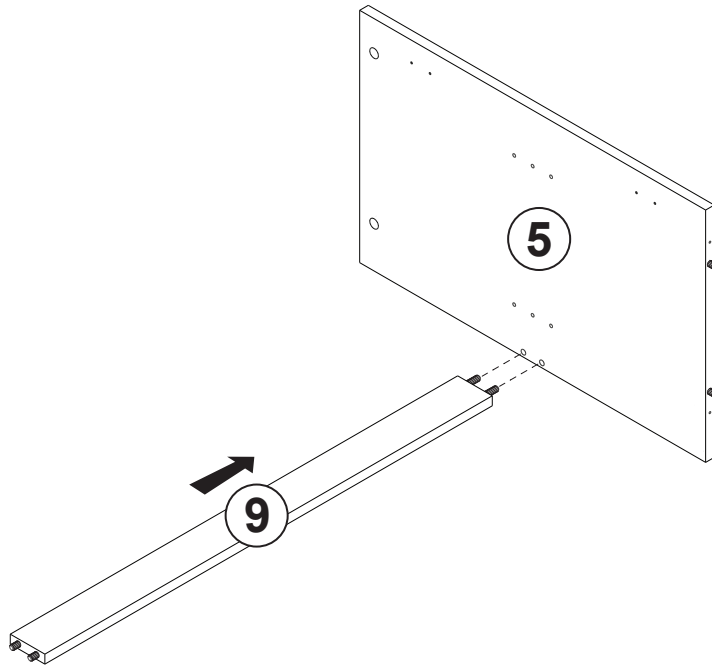

3

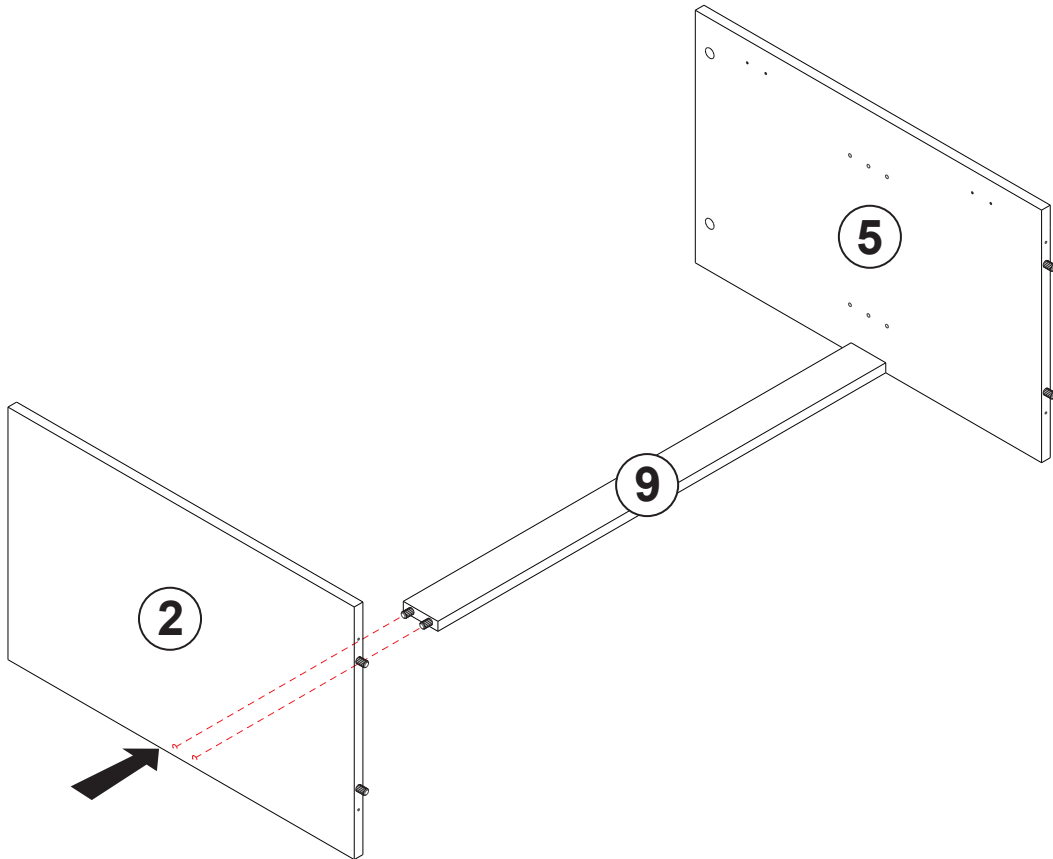

4

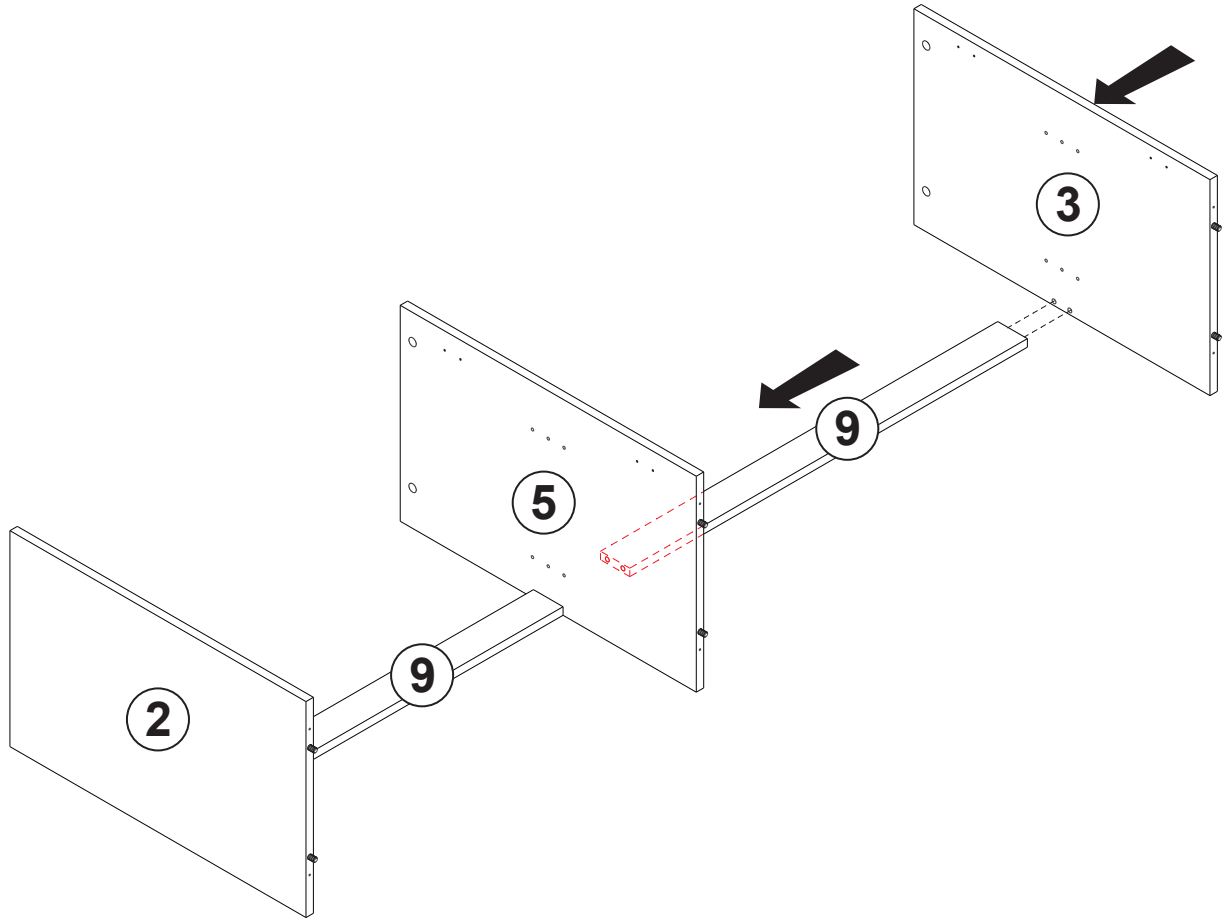

5

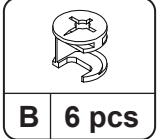
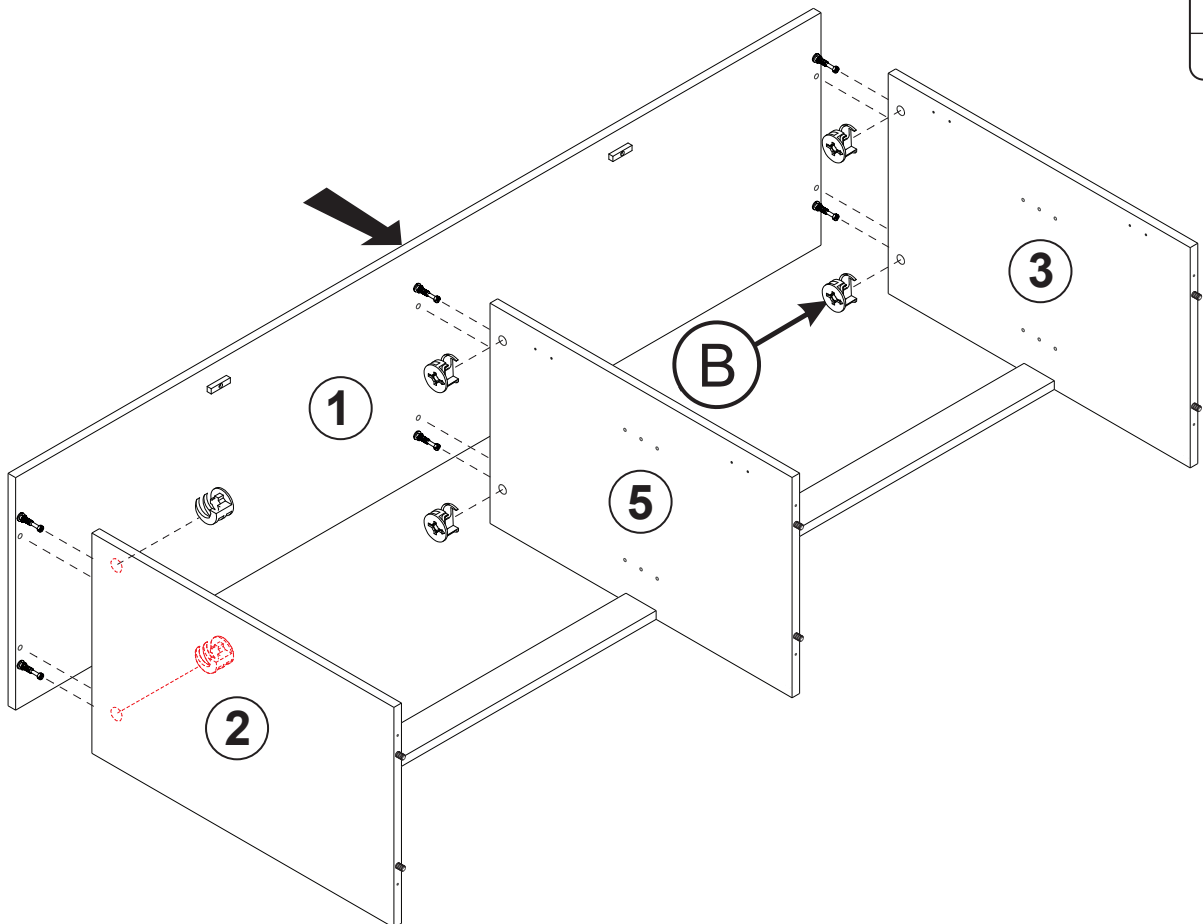

6

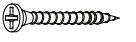

D 6 pcs

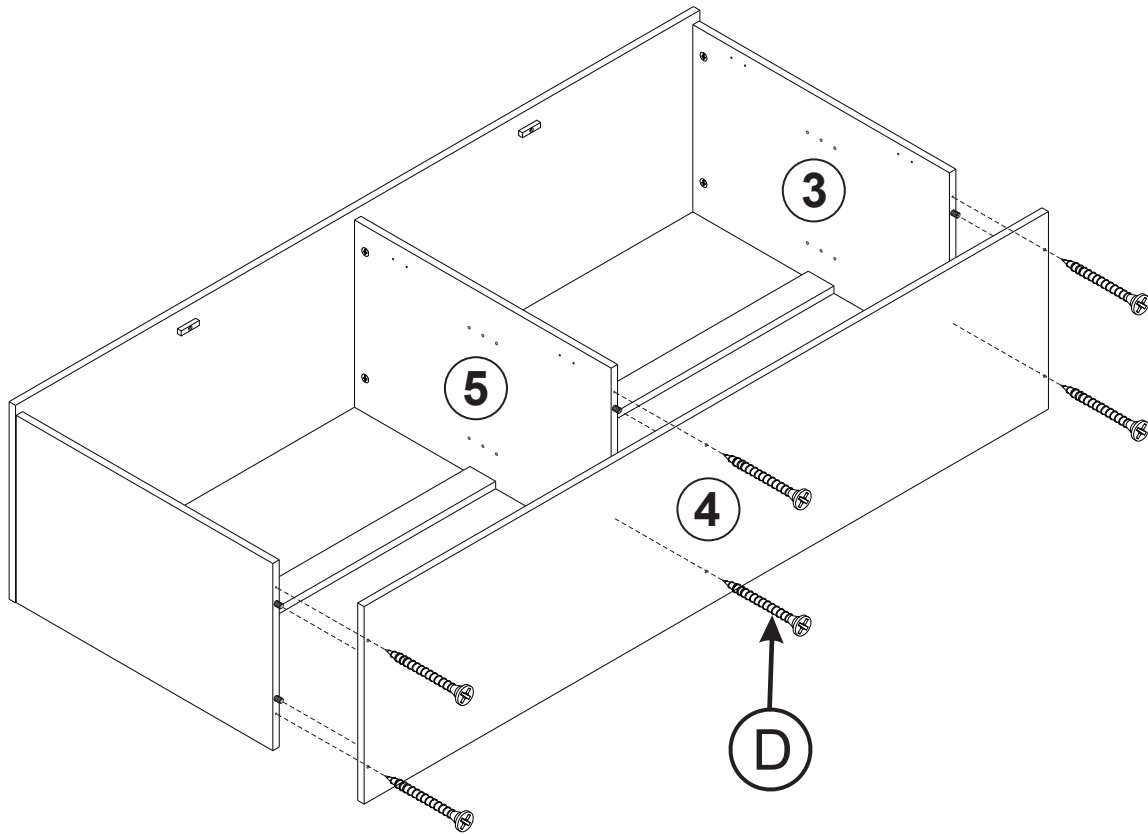

7



E 20 pcs



I 5 pcs

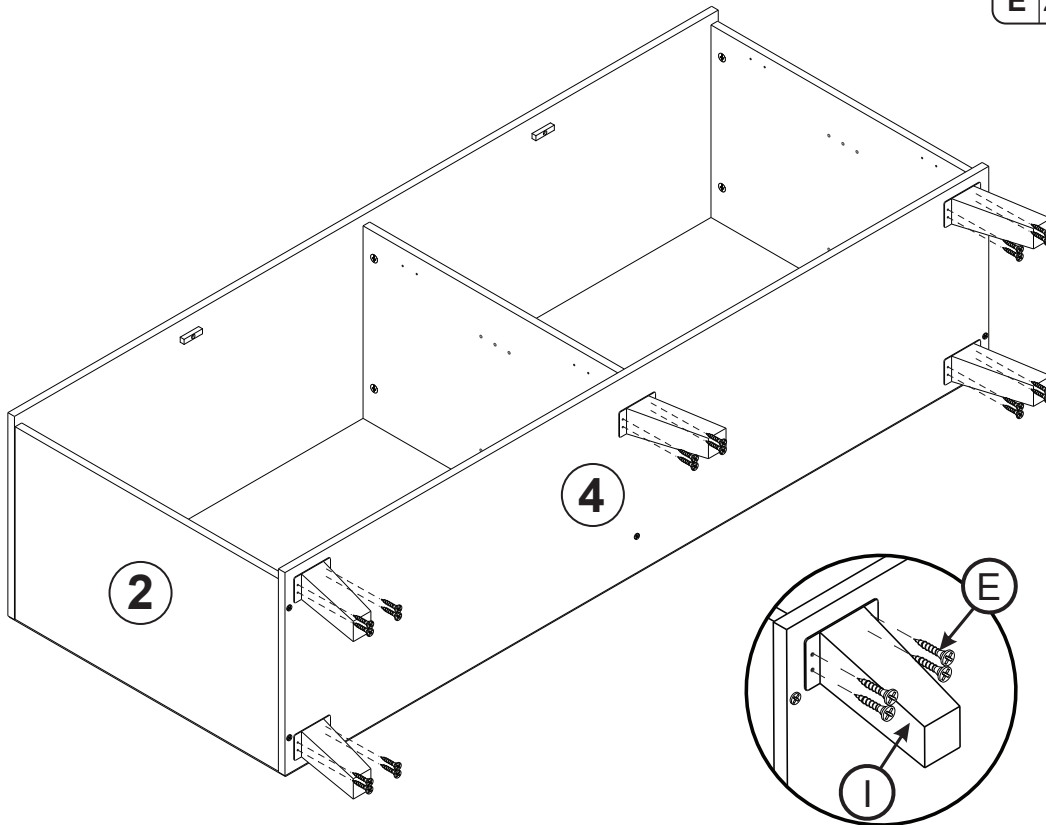

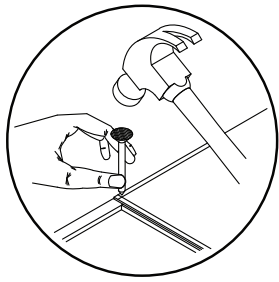

8



TURN BACK

H

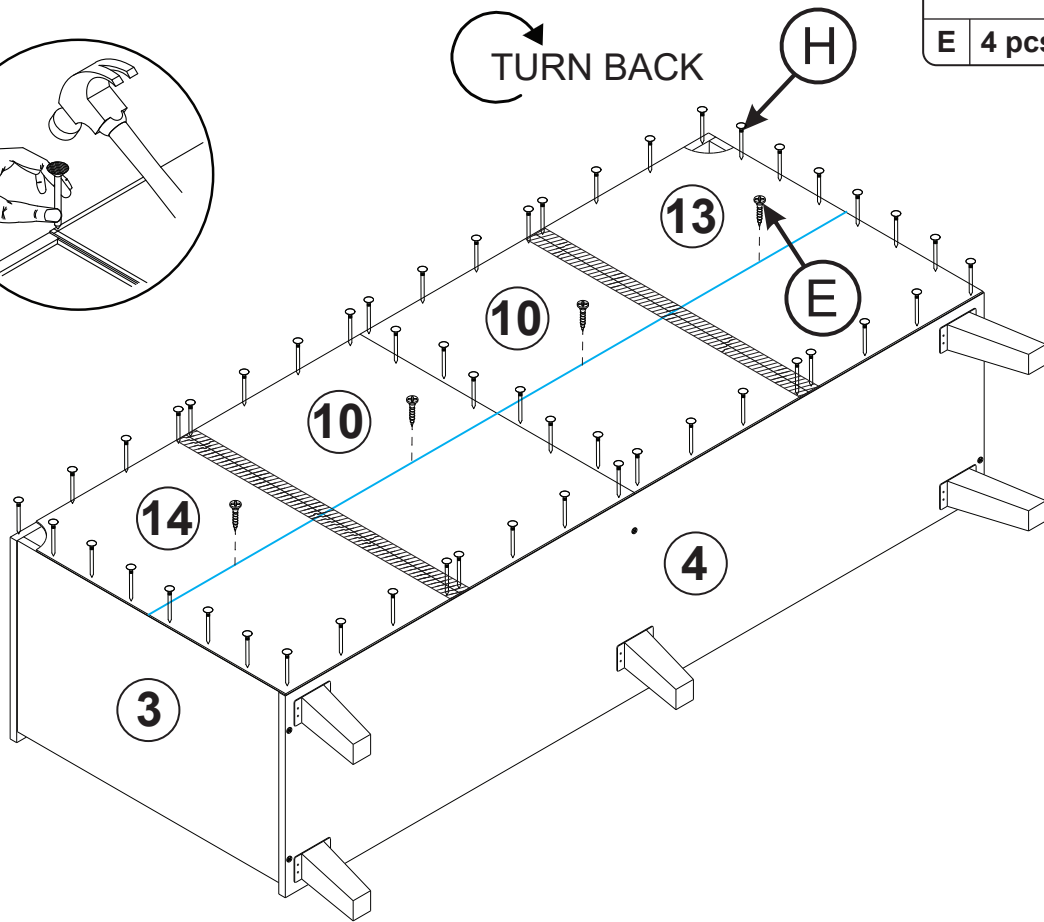

E 4 pcs

H 50 pcs



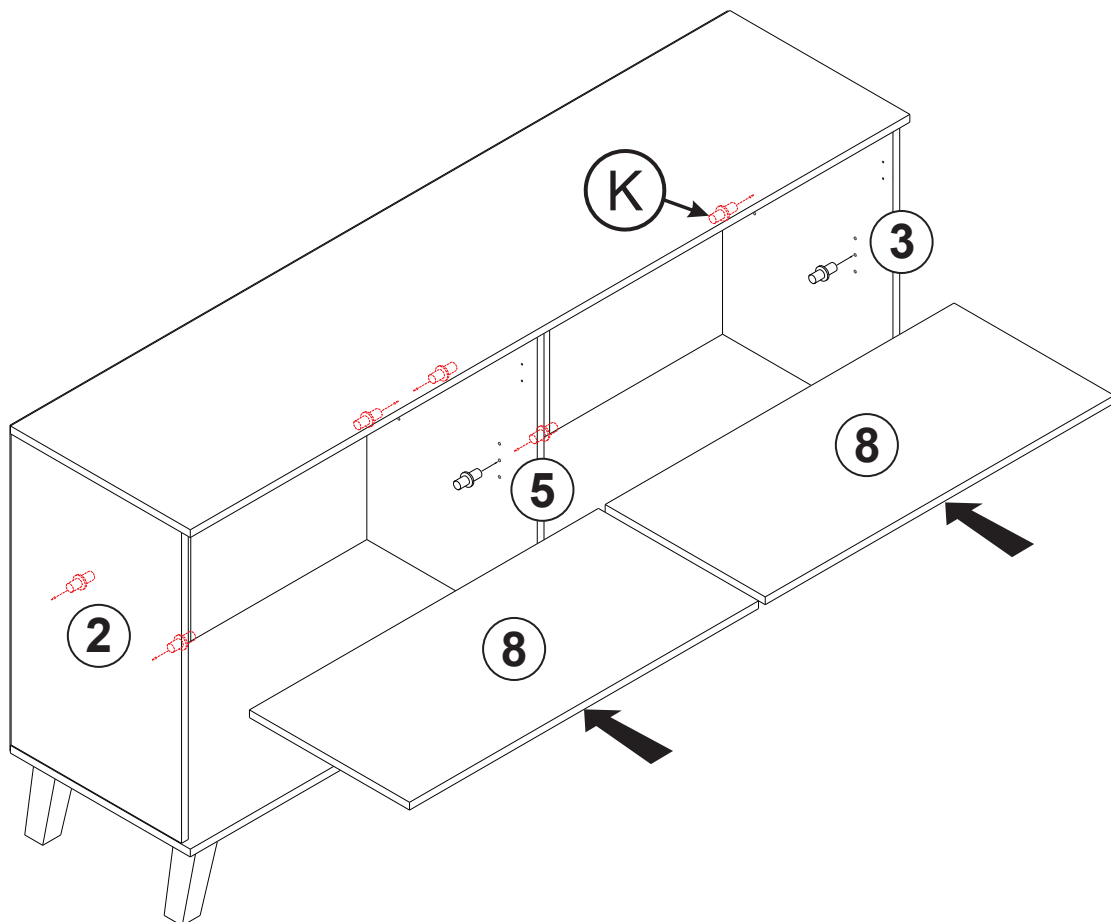

9

K 8 pcs



11

	
E 20 pcs	J 2 pcs

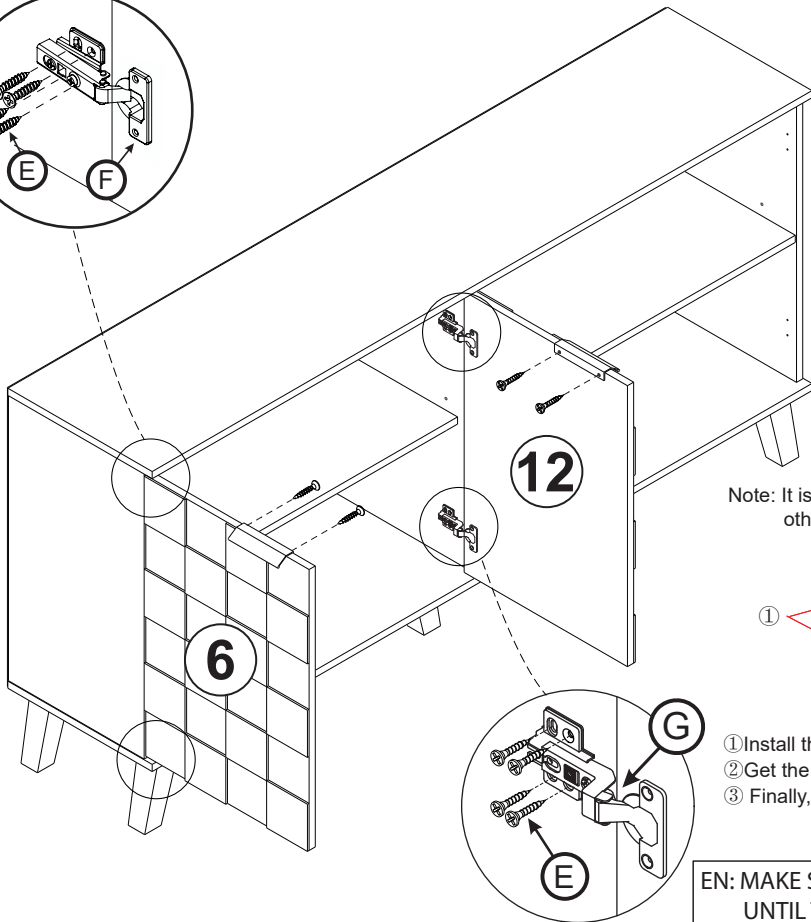
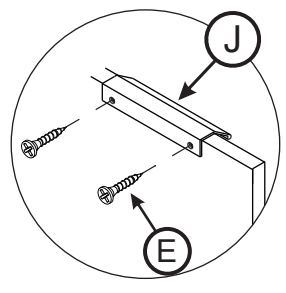
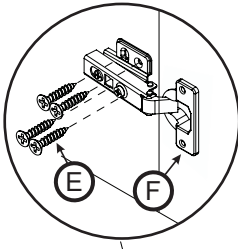

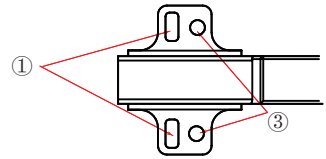

Note: It is forbidden to install the fixing hole screws first, otherwise it will lead to installation failure!



- ① Install the adjustment hole screws first
- ② Get the door in the right position
- ③ Finally, install the fixing hole screws

EN: MAKE SURE ADJUST THE HINGES UNTIL THE DOOR FITS INTO PLACE.

12

	
E 20 pcs	J 2 pcs

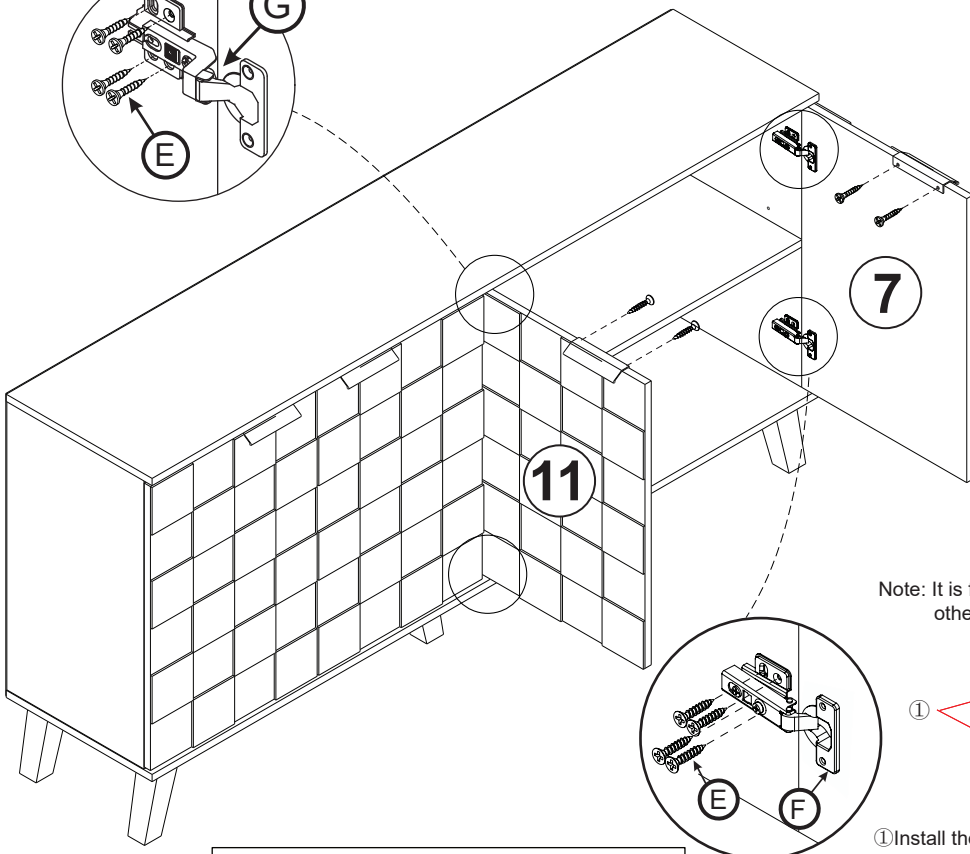
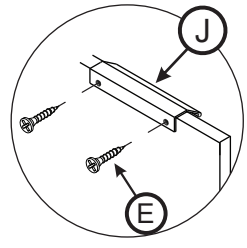
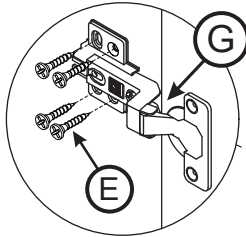

Note: It is forbidden to install the fixing hole screws first, otherwise it will lead to installation failure!

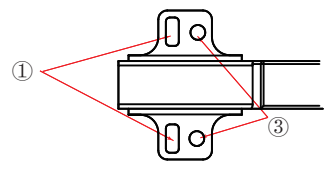

- ① Install the adjustment hole screws first
- ② Get the door in the right position
- ③ Finally, install the fixing hole screws

EN: MAKE SURE ADJUST THE HINGES UNTIL THE DOOR FITS INTO PLACE.

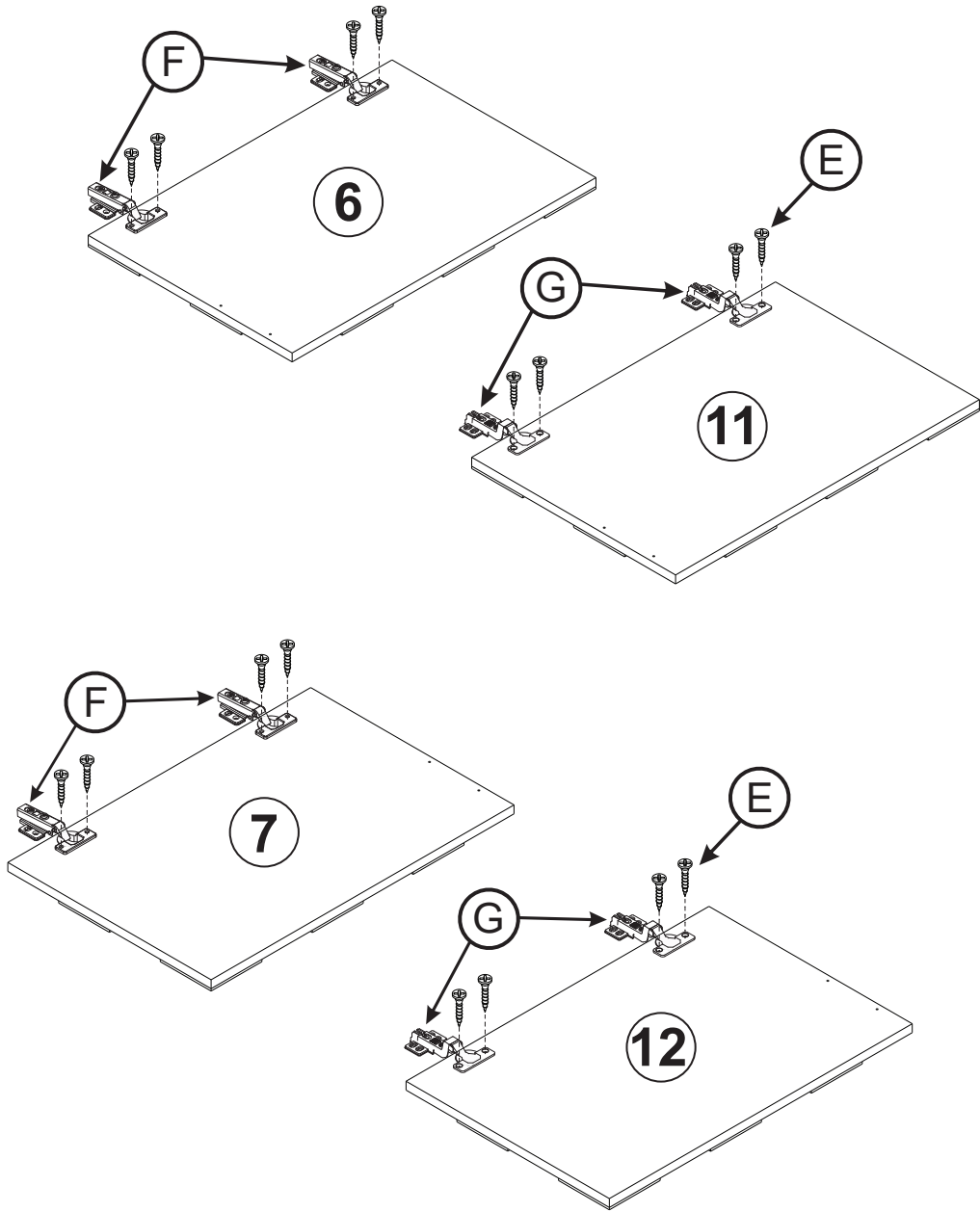
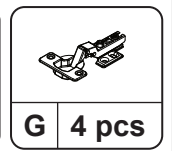
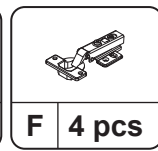
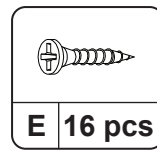

13

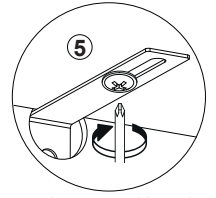
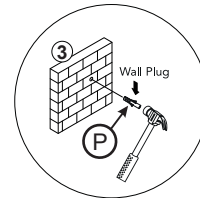
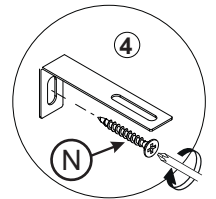
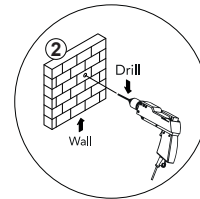
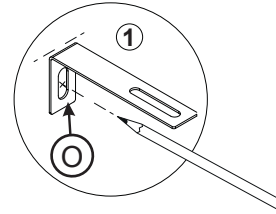
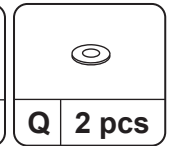
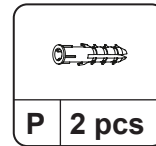
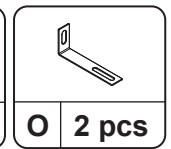
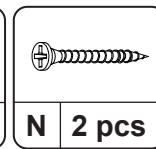
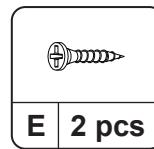
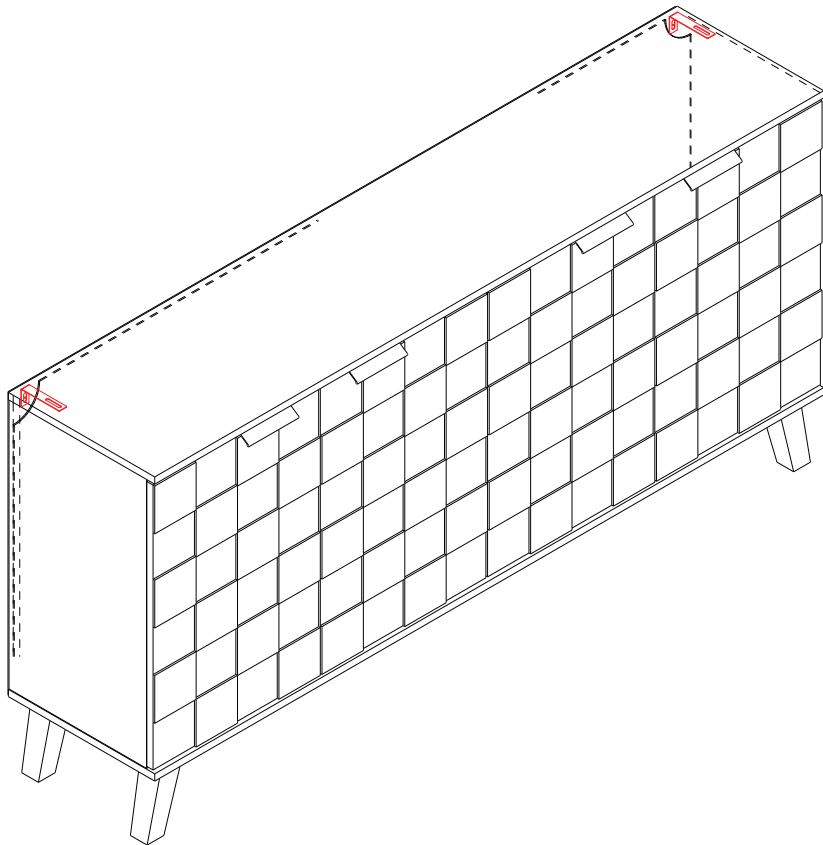

TIGHTEN THE SCREWS

14

