

# 86065 Stuhl Hojas Blau

EAN: 4025621860655



Email: [info@kare.de](mailto:info@kare.de)

**KARE Design GmbH** Zeppelinstraße 16, 85748 Garching-Hochbrück Germany

Geschäftsführende Gesellschafter: Jürgen Reiter, Peter Schönhofen

KARE Design GmbH HRB 164 249 Amtsgericht München Sitz: München Steuernummer: Finanzamt München für Körperschaften, 143/153/40064 USt-ID: DE 250 622 249

[www.kare.de](http://www.kare.de) [www.kare-design.de](http://www.kare-design.de)

# RISK OF TIPPING

## SAFETY INSTRUCTION



**D: Kippgefahr !** Bitte mit dem Stuhl nicht schaukeln! Nicht auf dem Stuhl stehen!

**GB: Risk of tipping !** Please do not swing the stool! Do not stand on the stool!

**FR: Risque de basculement !** S'il vous plaît ne pas se balancer sur le tabouret ! Ne pas monter sur le tabouret !

**NL : Kantelgavaar !** Gelieve niet te schommelen op de kruk ! Ga niet op de kruk staan !

**IT: Rischio di ribaltamento !** Non dondolare con lo sgabello ! Non montare sullo sgabello !

**RU: Опасность опрокидывания !** Пожалуйста на стуле не качаться, на стул ногами не вставать!

**PL: Ryzyko wywrocenia.** Proszę nie chustac się na krzesle. Nie stawac na krzesle.

**TR: Devrilme tehlikesi var!** Sandelye üzerinde sallanmayınız! Sandelyenin üzerinde ayakta durmayınız!

**RO: Risc de răsturnare !** Vă rugăm să nu vă balansați pe scaun! Nu stați în picioare pe scaun !

**SK: Varovanie, možnosť úrazu!** Prosíme, aby ste sa nehojdali na stoličke! Nestojte na stoličke!

**CZ: Riziko převrácení!** Nehoupejte se na stoličce! Nestoupejte na stoličku!

**HU: Vigyázz!** Borulekony! Räälni tilos!

**BG: Опасност от преобръщане!** Моля, не клатете стола! Не стойте върху стола!

**DK: Fare for at vælte!** Lad være med at vippe med stolen! Stå ikke på stolen!

**EST: Kukkumisoht!** Palun ärge kiigutage tooli! Ärge seiske tooli peal!

**FN: Kaatumisvaara!** Älä keinuta tuolia! Älä seiso tuolin päällä!

**GR: Κίνδυνος ανατροπής!** Μην κουνάτε την καρέκλα! Μην στέκεστε πάνω στην καρέκλα!

**LV: Apgāšanās bīstamība!** Lūdzu, nešūpojiet krēslu! Nestāviet uz krēsla!

**LTU: Apvirtimo pavojus!** Prašome nejudinti kėdės! Nestovėkite ant kėdės!



**PRT: Perigo de queda!** Não balançar a cadeira! Não se apoie na cadeira!

**SWE: Risk för tippning!** Vänligen gunga inte stolen! Stå inte på stolen!

**SVN: Nevarnost prevrnitve!** Stola ne zibajte! Ne stojte na stolu!

**ESP: ¡Peligro de vuelco!** No balancee la silla. No se suba a la silla.

# 86064: Chair Hojas Blue

A		x4
B		x4

Finish

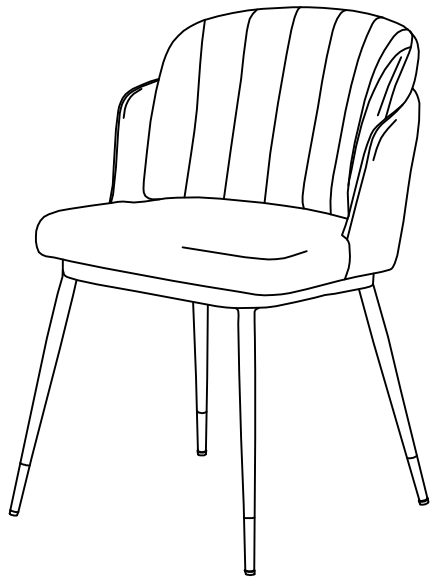

0138054

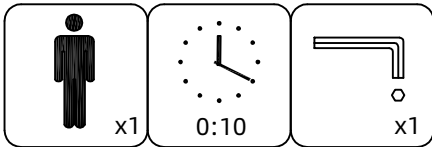



Step:1

# KARE

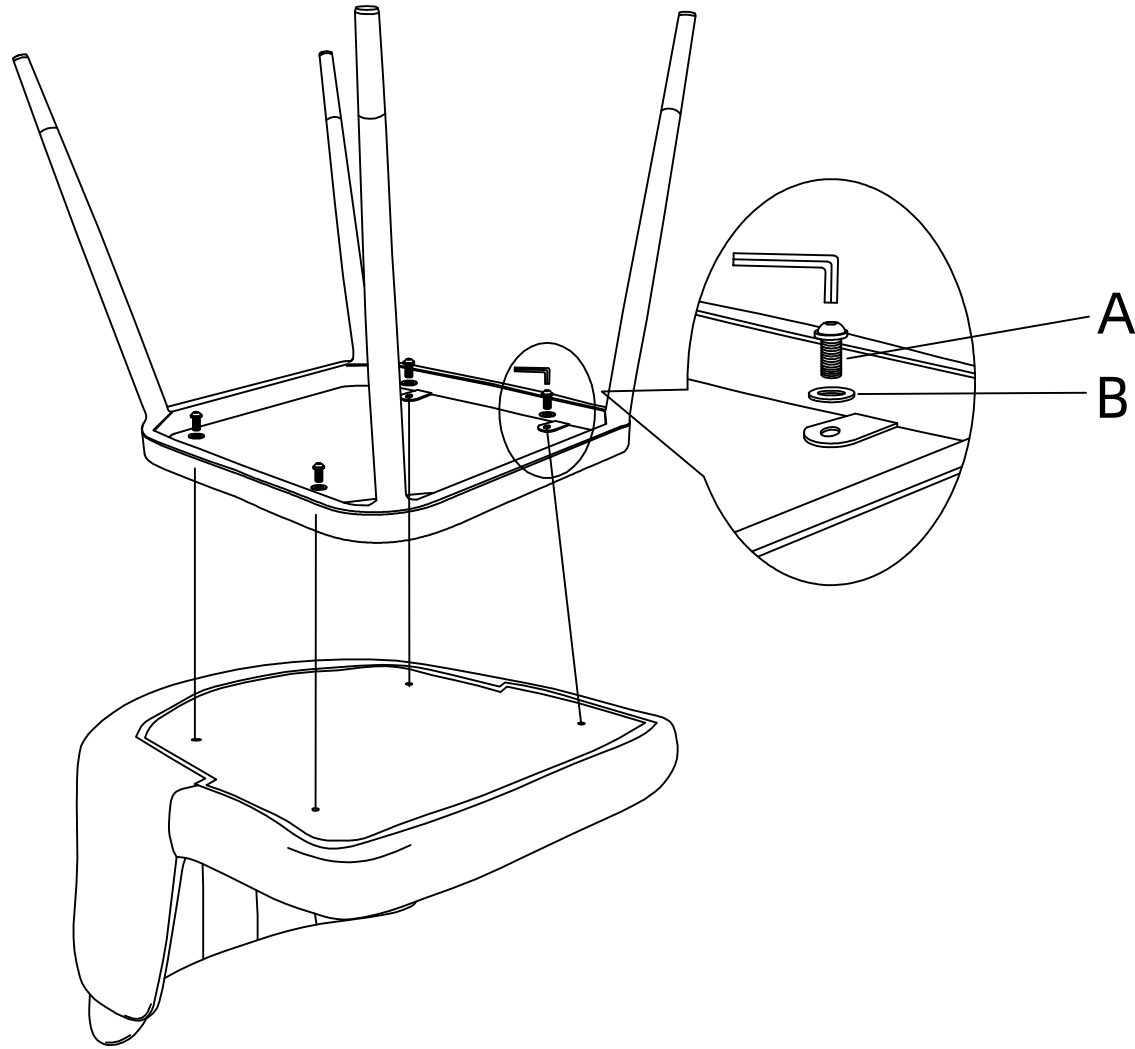
DESIGN



# 86064: Chair Hojas Blue

A		x4
B		x4

Finish

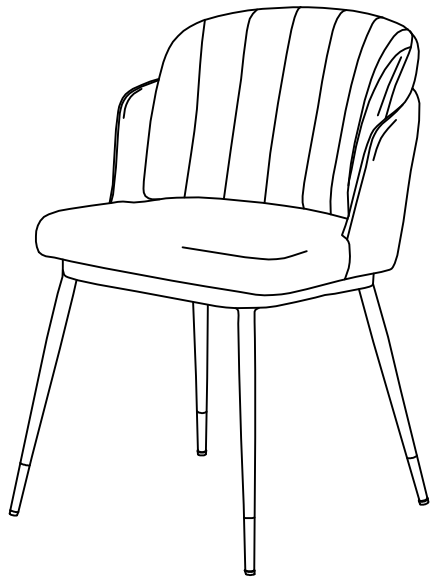

0138054

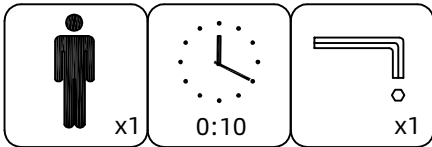

Step:1

# KARE

DESIGN

