

**ALTAIR**

[www.altairdesignusa.com](http://www.altairdesignusa.com)

# Installation Manual for LED Bathroom Mirror

---

(Suitable for the touch switch products installation by hanging bar or hardy hold)

779024-LED-GM 779024-LED-BC

---

Notes: to ensure the normal use of products, it is required set out wires as per the regulations of IEE at the installation places. The products are only applicable to be installed on the indoor. The installation must be executed by a professional electrician, wrong installation may lead to product damage and personal injury.

---

**ALTAIR**

[www.altairdesignusa.com](http://www.altairdesignusa.com)

# Exploded view

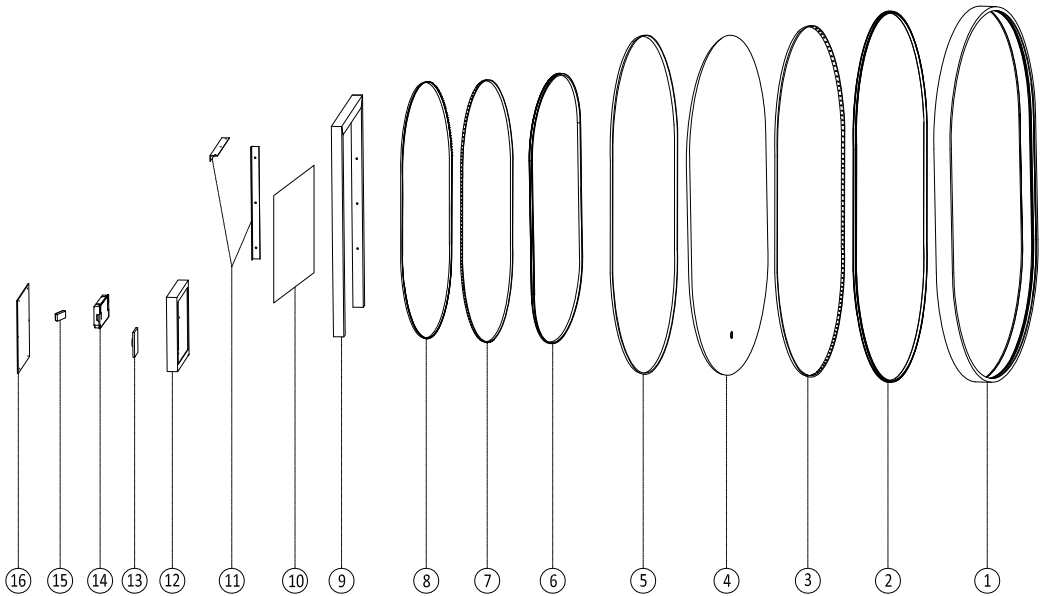

Part	Description
1	Aluminum Frame
2	LED Strip
3	Lighting Diffuser
4	Mirror
5	EVA
6	Aluminum For Light
7	LED Strip
8	Lighting Diffuser
9	Aluminum Frame
10	Defogger
11	Hanging Bracket
12	Eletrical Box Frame
13	Touch Switch
14	LED Driver
15	Relay
16	Back Cover

# Hanging bar Installation Manual (Instruction for LED bathroom mirror)



① Horizontal the hanging bar  
mark with a pen in the hanging bar hole

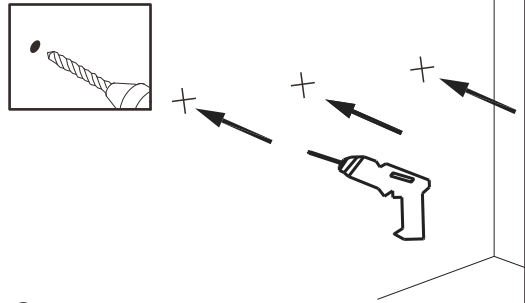

② To use the drill to have the holes

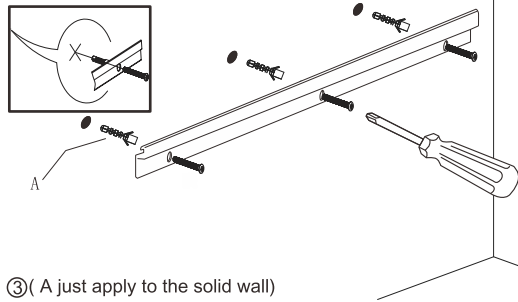

③ (A just apply to the solid wall)  
Put the expansion plug into the wall hole  
both the wall holes and the hanging bar holes are match.  
To use the screwdriver to make the screw tightly

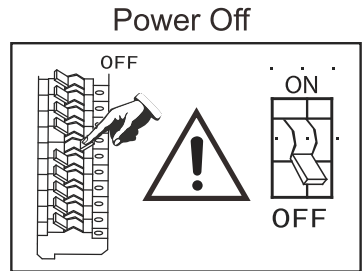

④ Please cut off all the power before the connection

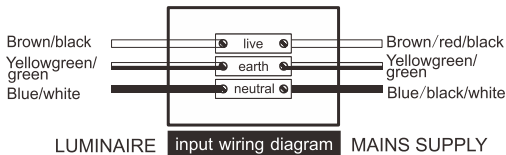

⑤ To connect as per above photo

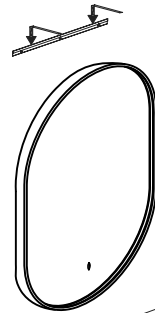

⑥ Hang up the mirror  
shake left and right to see if it is stable

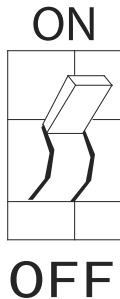

⑦ Turn on the power

## Function usage



“Switch ” sign

Follow below instructions to operate the mirror light:

1. Single TOUCH to turn ON light and activate anti-fog function.
2. Single TOUCH to select the LED temperature (3000K, 4000K or 6000K).
3. HOLD button to begin the dimming function. Release when the desire setting is achieved.
4. Single TOUCH to turn OFF.

## Parts list

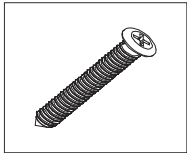

ST4.2 screw

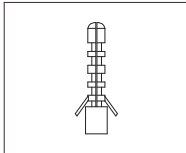

D8 expansion screw

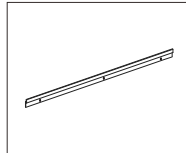

Aluminum hanging bar

## Installation tools (as shown below)

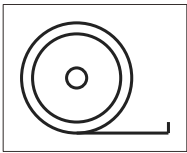

Flexible rule

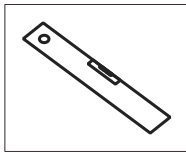

Leveling instrument

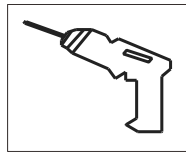

Churn drill

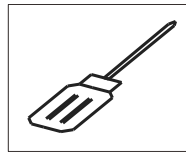

Screwdriver

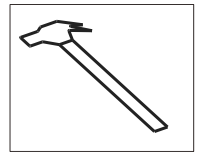

Hammer

## Warm tips:

- 1、 Please do not use,if the product have any broken.
- 2、 During operation,never put hard and sharp materials directly against the mirror surface. Otherwise, it may result in current leakage and even personal injury accident.
- 3、 Never forget to turn off the power switch in storm days. Otherwise,lightning may damage electric elements of the product.
- 4、 During normal operation, never forcibly pull out the power plug to stop the product. Otherwise, electric elements of the product may be damaged.
- 5、 Please pull out the power plug if the product is not used for a long time.
- 6、 In case of functional failure of the product, users are not allowed to disassemble and repair without authorization, otherwise, our company will not be responsible for any safety accidents