



## **INSTRUCTIONS MANUAL**

### **Half Round Rattan Armrest with Curved Shape Glider Swivel Chairs of 2**

**Loosely assemble before tightening.**

## **WARNING:**

Proper use of the chair is for single person seating only. The chair is not to be used for standing purposes and will not function as a stool or step-ladder. Use on even surfaces only. chair tested for use at weight of 350lb (159kg). Improper use of this product or failure to use as directed may result in injury. Not intended for commercial use.

## **IMPORTANT:**

Please read all the instructions and warnings before assembling. In order to make the whole product adjust to the best, please install all the screws on the product before fully tighten, and note to put the washer to the screw before putting the screw into the screw hole.





## **SAFETY INFORMATION:**



- Keep all children and pets away from assembly area. Children and pets should be supervised when they are in the area of the product construction.
- Keep assembly area at least 6 feet from any obstruction such as a fence, garage, house, overhanging branches, laundry line or electrical wires.
- Some parts may contain sharp edges. When assembling and using this product, basic safety precautions should always be followed to reduce the risk of personal injury and damage to the product. Please read all instructions before assembly and use.
- Check all bolts for tightness before use. **IMPORTANT** - check and tighten bolts often to keep them secure!
- The chair is not to be used for standing purposes and will not function as a stool or step-ladder. Use on even surfaces only.
- The chair use at weight of 350lb (159kg). Improper use of this product or failure to use as directed may result in injury. Not intended for commercial use.





## **CARE & MAINTENANCE :**

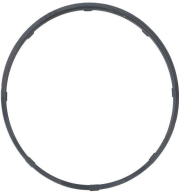



- **STAIN RESISTANT CUSHIONS CARE :KEEP THE CUSHIONS IN STORAGE IN RAINING DAY.**
- **SPILLS:** Immediately wipe up the spill using a white damp cloth. Repeat process if necessary until stain is gone. Allow cushion to air dry.
- **FABRIC CARE:** Hand wash cold, non-chlorine bleach when needed, lay flat to dry. Cool iron if necessary. Do not dry clean.
- **RESIN WICKER PRODUCT CARE:** Before using, clean the product completely with a soft dry towel. When not in use, wipe free of any dirt or loose objects, wash with a mild solution of soap and water, rinse thoroughly and dry completely. Do not use strong detergent or abrasive cleaners. Over time nuts and bolts can loosen. Occasionally, check nuts and bolts, re-tighten if necessary.
- **Warranty period:** 180 days.

## Assembly Instructions for 1PC Swivel Chair

<b>AL</b>	<b>AR</b>	<b>B</b>	<b>C</b>
			
AL 1PC Left Arm	AR 1PC Right Arm	B 1PC Chair Back	C 1PC Front Panel

<b>D</b>	<b>E</b>	<b>F</b>	<b>G</b>
			
D 1PC Seat Panel	E 1PC Base	F 2PC Short Connecting Rob	G 1PC Long Connecting Rob

<b>H</b>	<b>I</b>	<b>J</b>	<b>K</b>
	 <b>M6*35mm</b>		 <b>Ø16*Ø6.5*1mm</b>
H 1PC Swivel Plate	I 22PC Bolt	J 1PC U-shaped Fitting	K 22PC Washer

<b>L</b>	<b>M</b>	<b>N</b>	<b>O</b>
	 <b>M6*40mm</b>	 <b>M6*16mm</b>	
L 1PC Allen Wrench	M 4PC Bolt	N 8PC Bolt	O 14PC M6 Nut

<b>P</b>	<b>Q</b>	<b>R</b>	
			
P 1PC Open End Allen Wrench	Q 1PC Seat Cushion	R 1PC Back Cushion	

**Tools:**

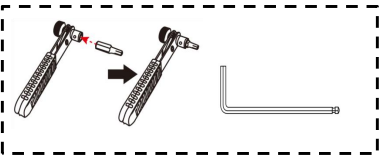

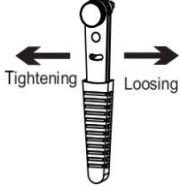

**Ratchet Wrench**

1. Secure chair arms (AL&AR) to chair back (B) with 4 bolts (I) and 4 washers (K) by using allen wrench (L). **Keep the bolts loose.**

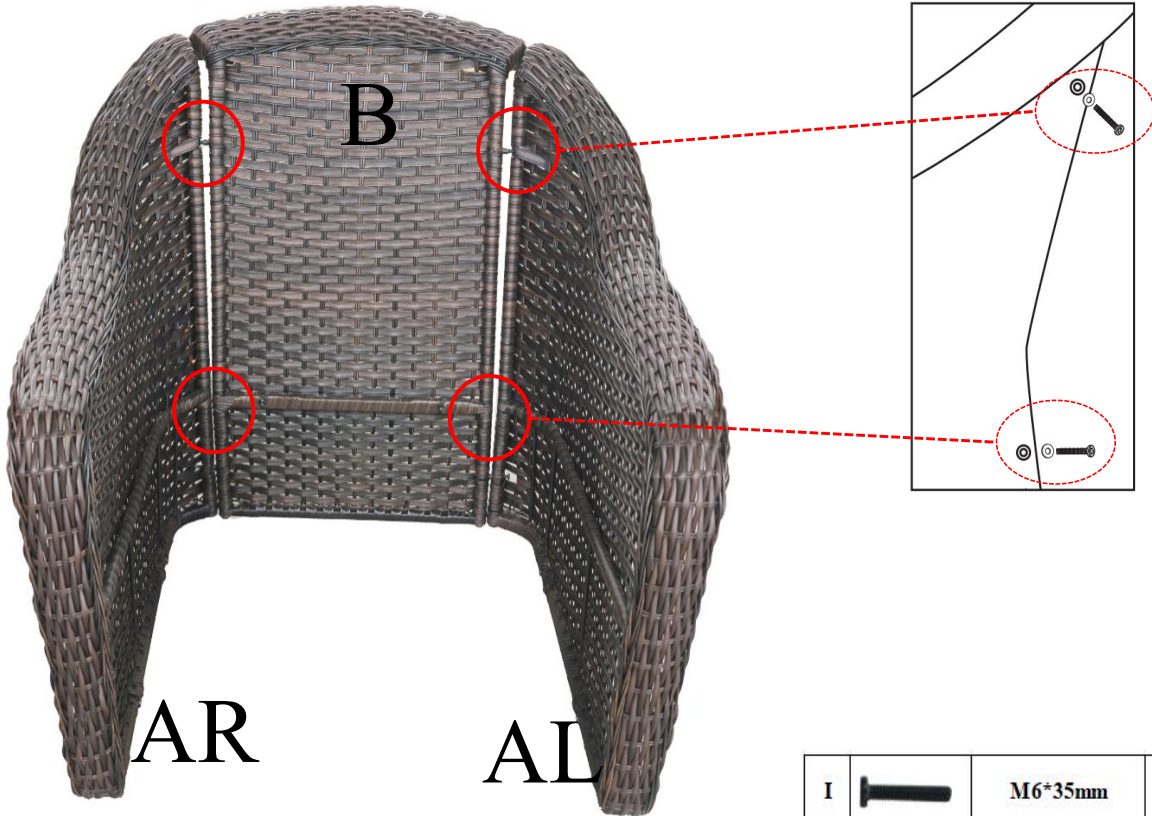

I		M6*35mm	4
K		Ø16*Ø6.5*1mm	4

2. Secure assembled chair arms (AL&AR) to front panel (C) with 4 bolts (I) and 4 washers (K) by using allen wrench (L). **Keep the bolts loose.**

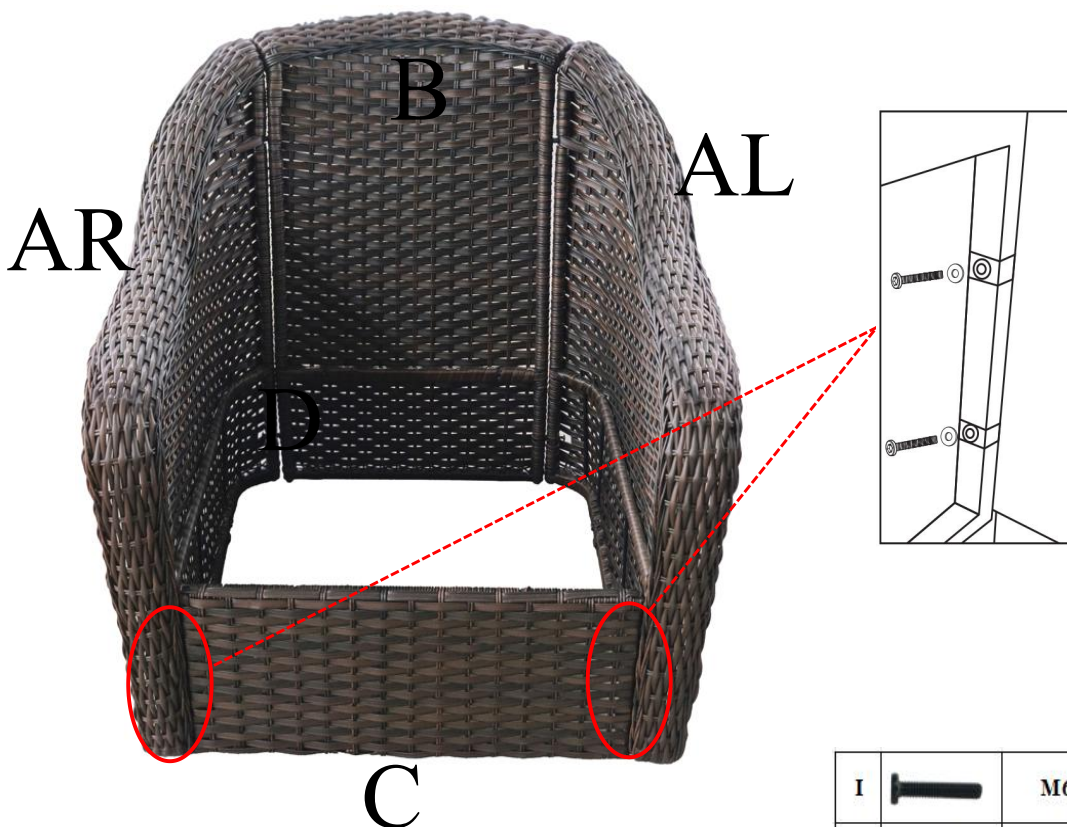

I		M6*35mm	4
K		Ø16*Ø6.5*1mm	4

3. Secure seat panel (D) to assembled chair back (B) and assembled front panel (C) with 4 bolts (I) and 4 washers (K) by using allen wrench (L). **Keep the bolts loose.**  
**Note: Seat panel with arc shape should face sofa back.**

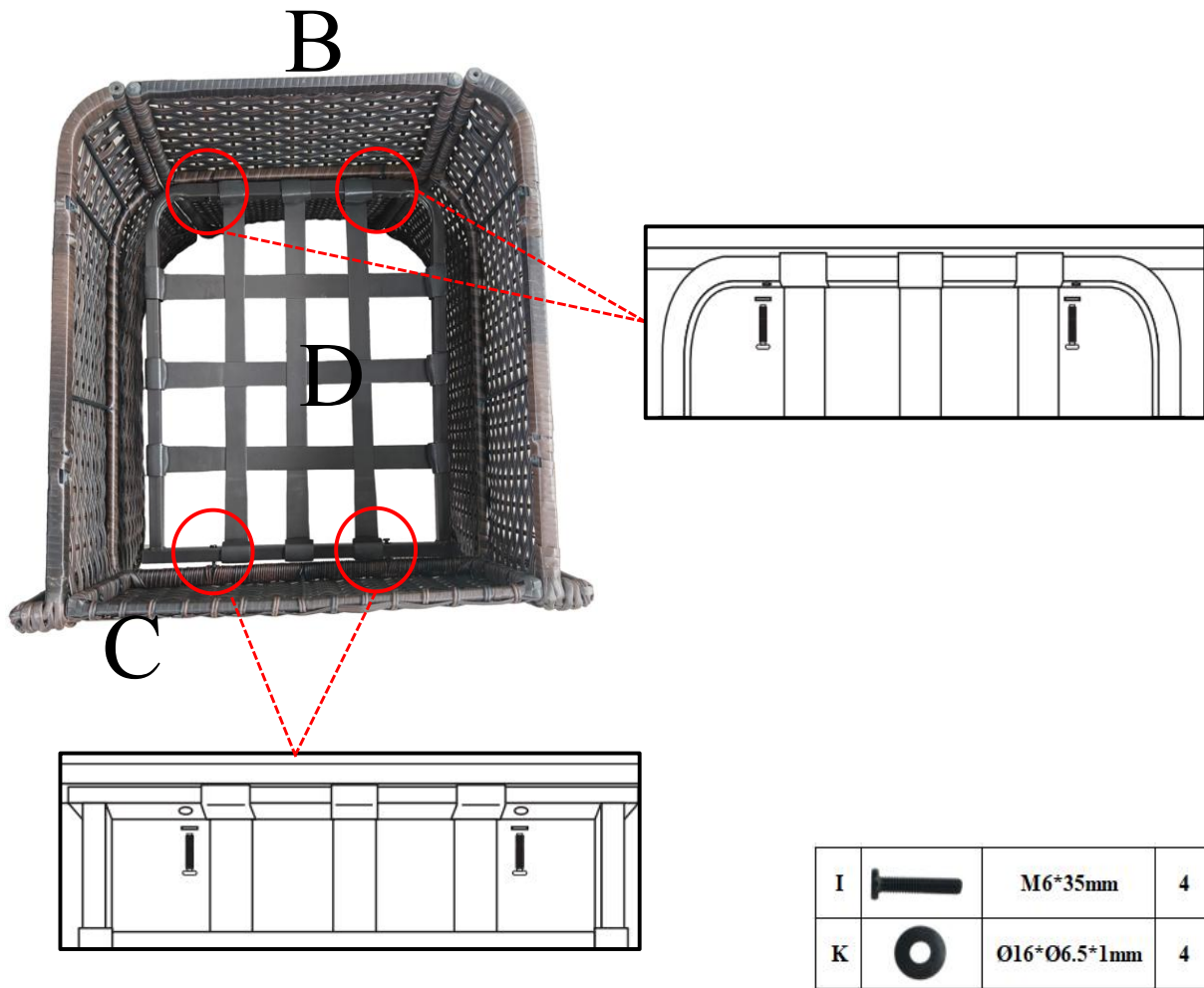

4. Secure short connecting robs (F) to long connecting (G) with 2 bolts (I), 2 nuts (O) and 2 washers (K) by using allen wrench (L) and open end allen wrench (P). **Keep the bolts loose.**

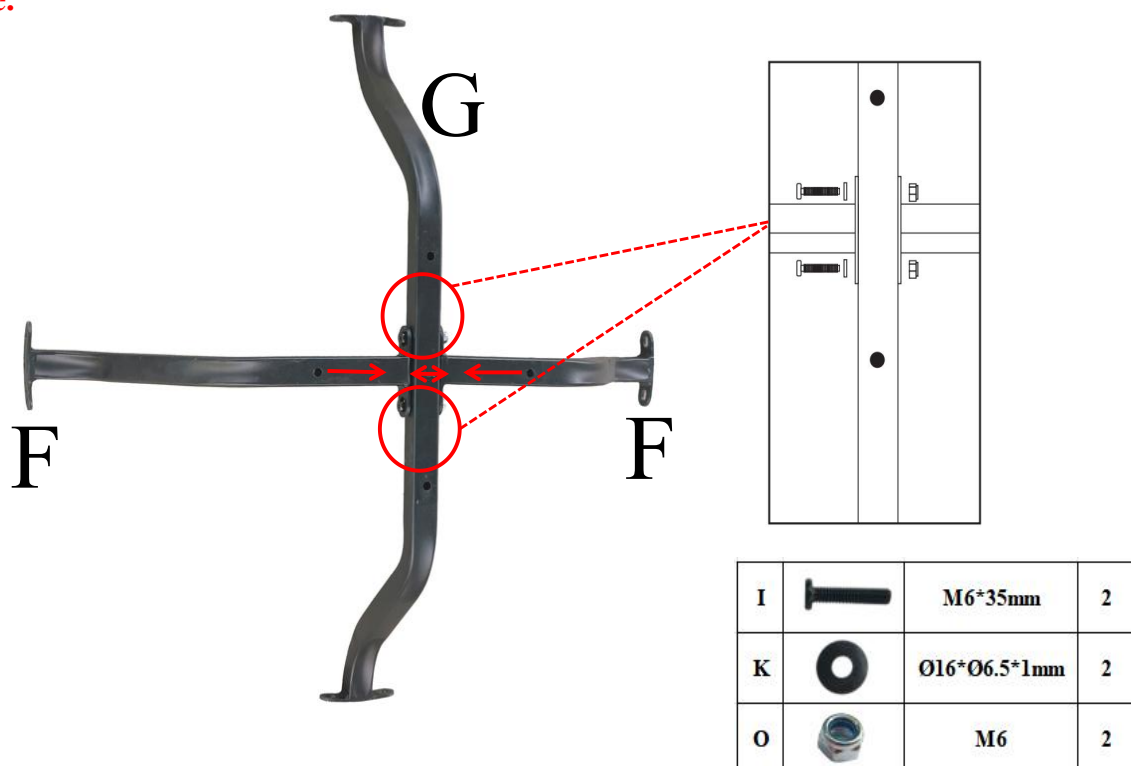

5. Secure base (E) to assembled connecting rods (F&G) with 8 bolts (N) and 8 washers (K) by using allen wrench (L). **Keep the bolts loose.**

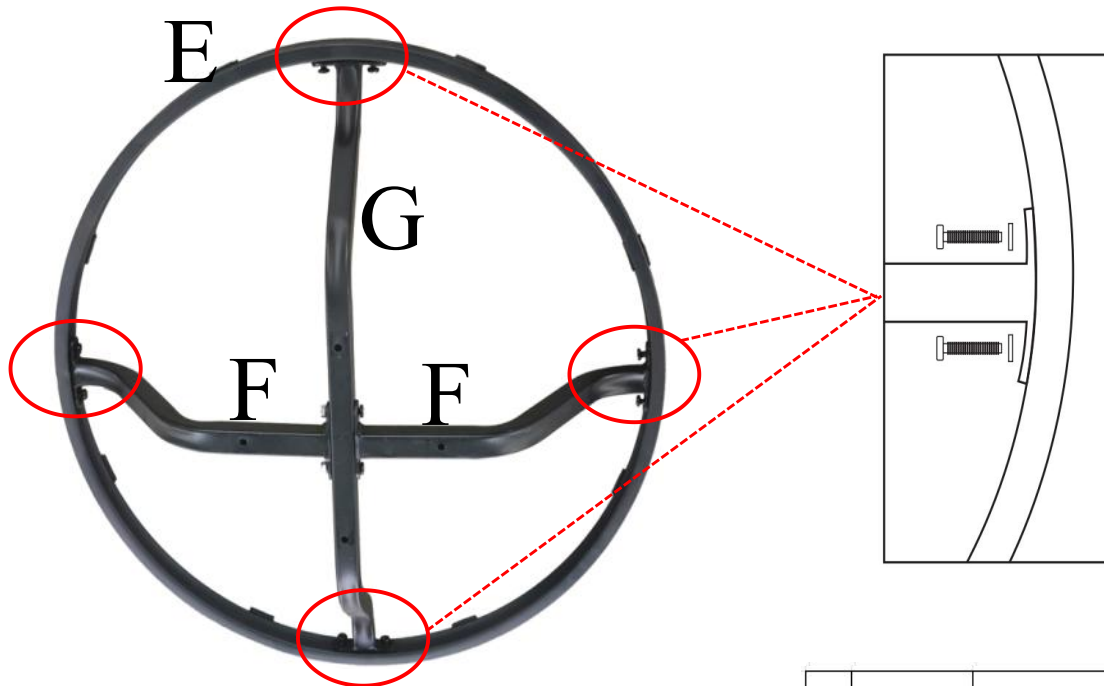

N		M6*16mm	8
K		Ø16*Ø6.5*1mm	8

6. Secure swivel plate (H) to assembled connecting rods (F&G) with 4 bolts (I) and 4 nuts (O) by using allen wrench (L) and open end allen wrench (P). **Keep the bolts loose.**

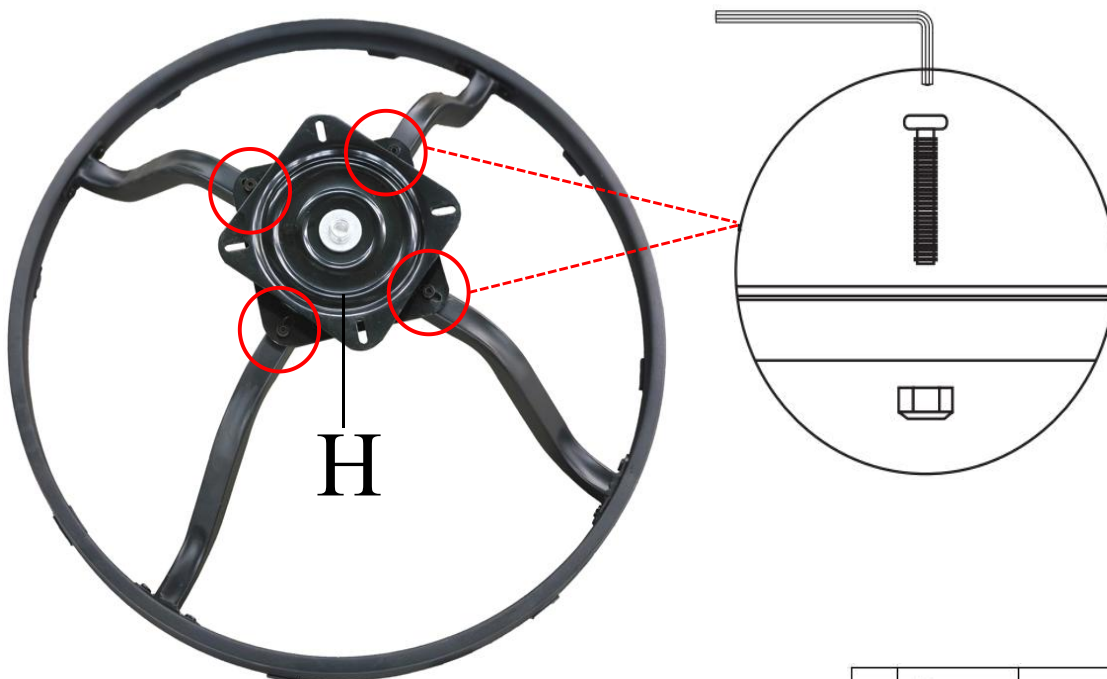

I		M6*35mm	4
O		M6	4

7. Secure U-shaped fitting (J) to assembled swivel plate (H) with 4 bolts (I) and 4 nuts (O) by using allen wrench (L) and open end allen wrench (P). **Keep the bolts loose.**

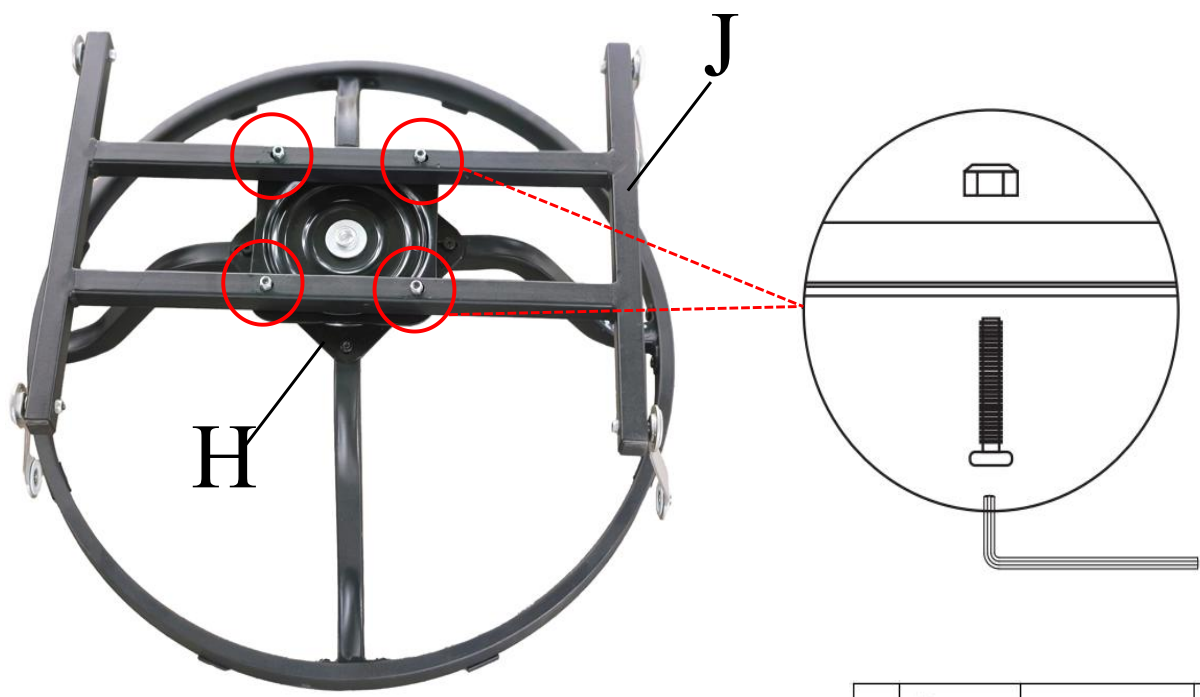

I		M6*35mm	4
O		M6	4

8. Secure assembled U-shaped fitting (J) to assembled chair arms (AL&AR) with 4 bolts (M) and 4 nuts (O) by using allen wrench (L) and open end allen wrench (P). **Keep the bolts (M) fully tightened.**

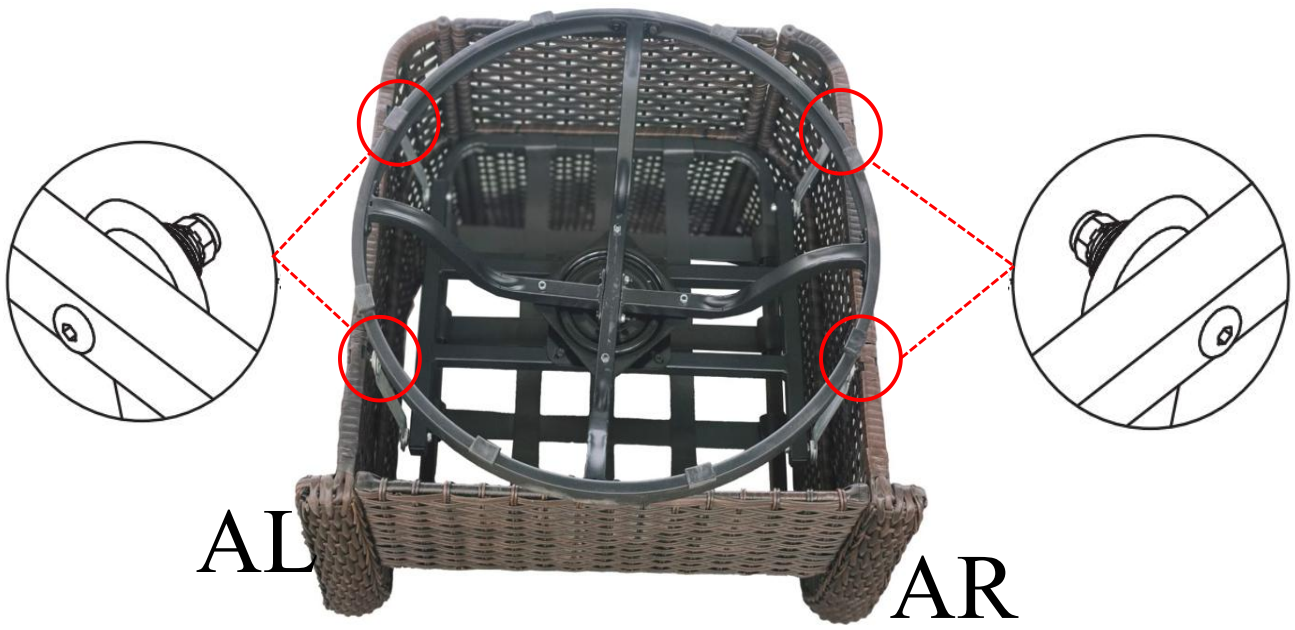

M		M6*40mm	4
O		M6	4

9. Tighten all bolts, put cushios (Q&R) onto the chair, it is ready to use now.



**SPECIAL WARNING:**

**THIS CHAIR IS NOT A TOY. DON'T OVER-SWING THE CHAIR. OVER-SWING THE CHAIR MAYBE MAKE THE CHAIR TIP OVER AND RESULT IN INJURY.**



**DO NOT STAND ON THE CHAIR. ANY IMPROPER USE OF THIS PRODUCT MAY RESULT IN INJURY.**

