

# DTP01

## ASSEMBLY & INSTRUCTION MANUAL

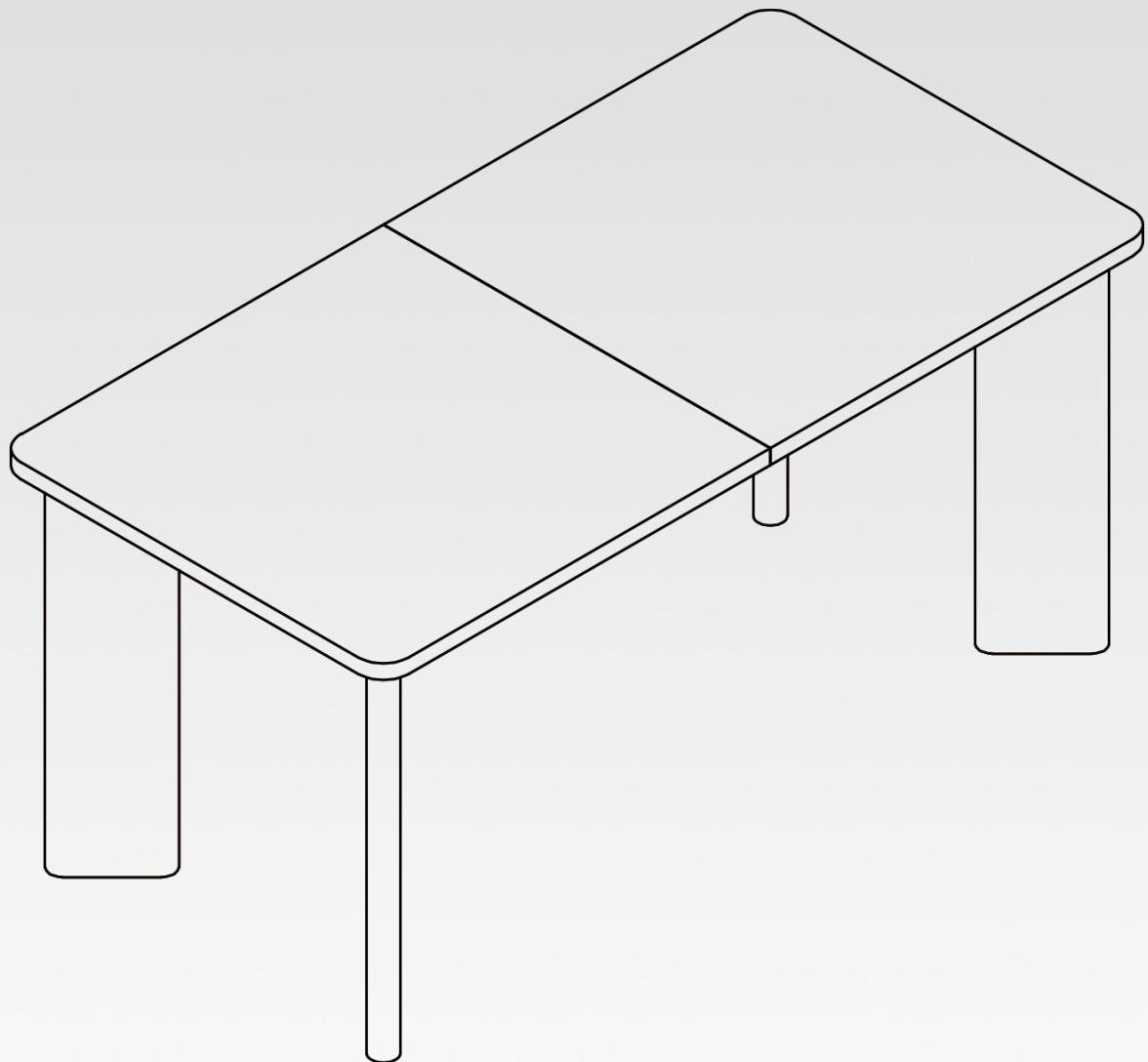

DINING TABLE



# CONTENTS

<b>01</b>	TECHNICAL EXPLODED VIEW DIAGRAM	Pg 01
<b>02</b>	PANEL COMPONENTS INVENTORY	Pg 02
<b>03</b>	ASSEMBLY INSTRUCTIONS	Pg 04
<b>04</b>	LIMITED WARRANTY	Pg 11

**TECHNICAL EXPLODED VIEW DIAGRAM**

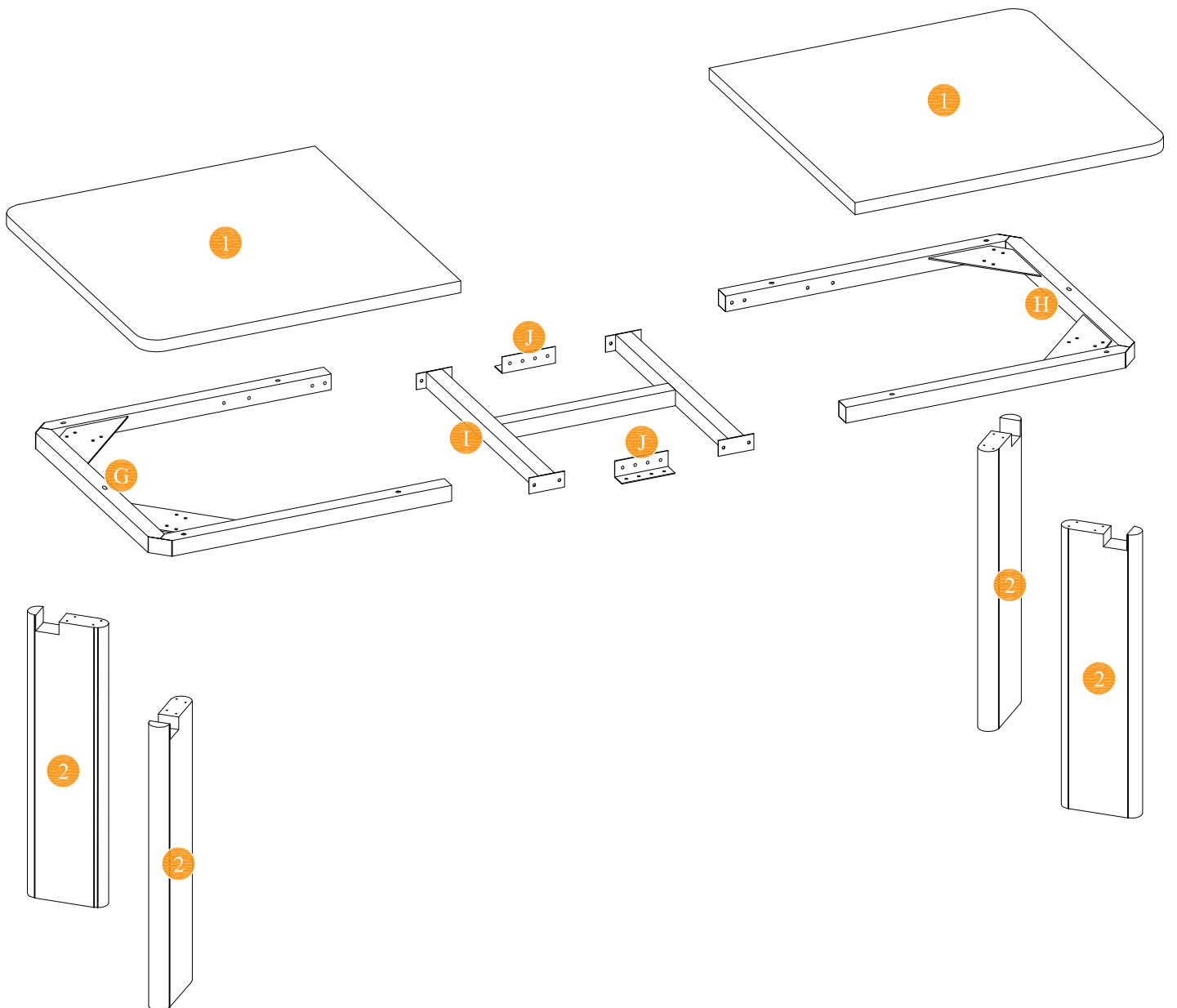

## PANEL COMPONENTS INVENTORY

PLEASE MAKE SURE ALL THE PARTS ARE INCLUDED

MISSING PARTS?  
[malolservice@hotmail.com](mailto:malolservice@hotmail.com)

1

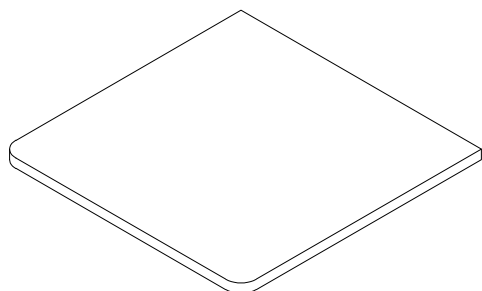

Top panel \*2

2

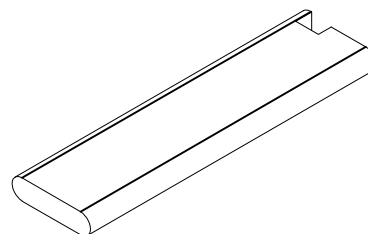

Table legs\*4

# PANEL COMPONENTS INVENTORY

PLEASE MAKE SURE ALL THE PARTS ARE INCLUDED

MISSING PARTS?  
[malolservice@hotmail.com](mailto:malolservice@hotmail.com)

A

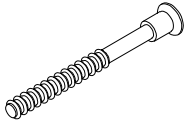

Flat Head Screw  
M7X70mm\*16(+1)

B

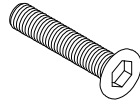

Hex Head Screw  
M6X55mm \*10(+1)

C



Hex Head Screw  
M6X12mm \*24(+2)

D



Spring  
Washers\*34(+2)

E



Flat Washers\*34(+2)

F



L-Wrench\*1

G

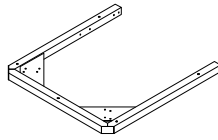

left frame\*1

H

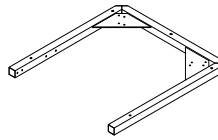

right side frame\*1

I

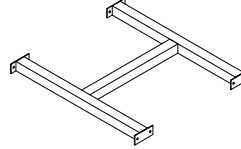

middle frame\*1

J

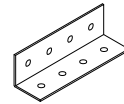

iron bonding\*2

K



Felt Disc \*4

BEFORE YOU GET STARTED, A FEW POINTERS:



Having a friend to help makes  
assembly extra-easy



Mind the important safety information

## ASSEMBLY INSTRUCTIONS

### **Important:**

1. Before assembly, arrange all panel components and hardware fittings in sequential order and verify quantity counts.

# ASSEMBLY INSTRUCTIONS

**STEP 1** Assemble the table frame.

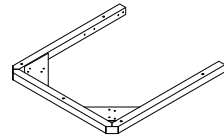

(G) left frame\*1

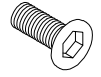

(C) Hex Head Screw  
M6X12mm \*8

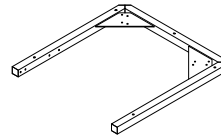

(H) right side frame\*1



(D) Spring  
Washers\*8

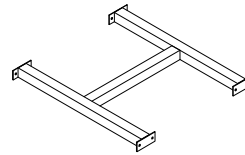

(I) middle frame\*1



(E) Flat Washers\*8



(F) L-Wrench\*1

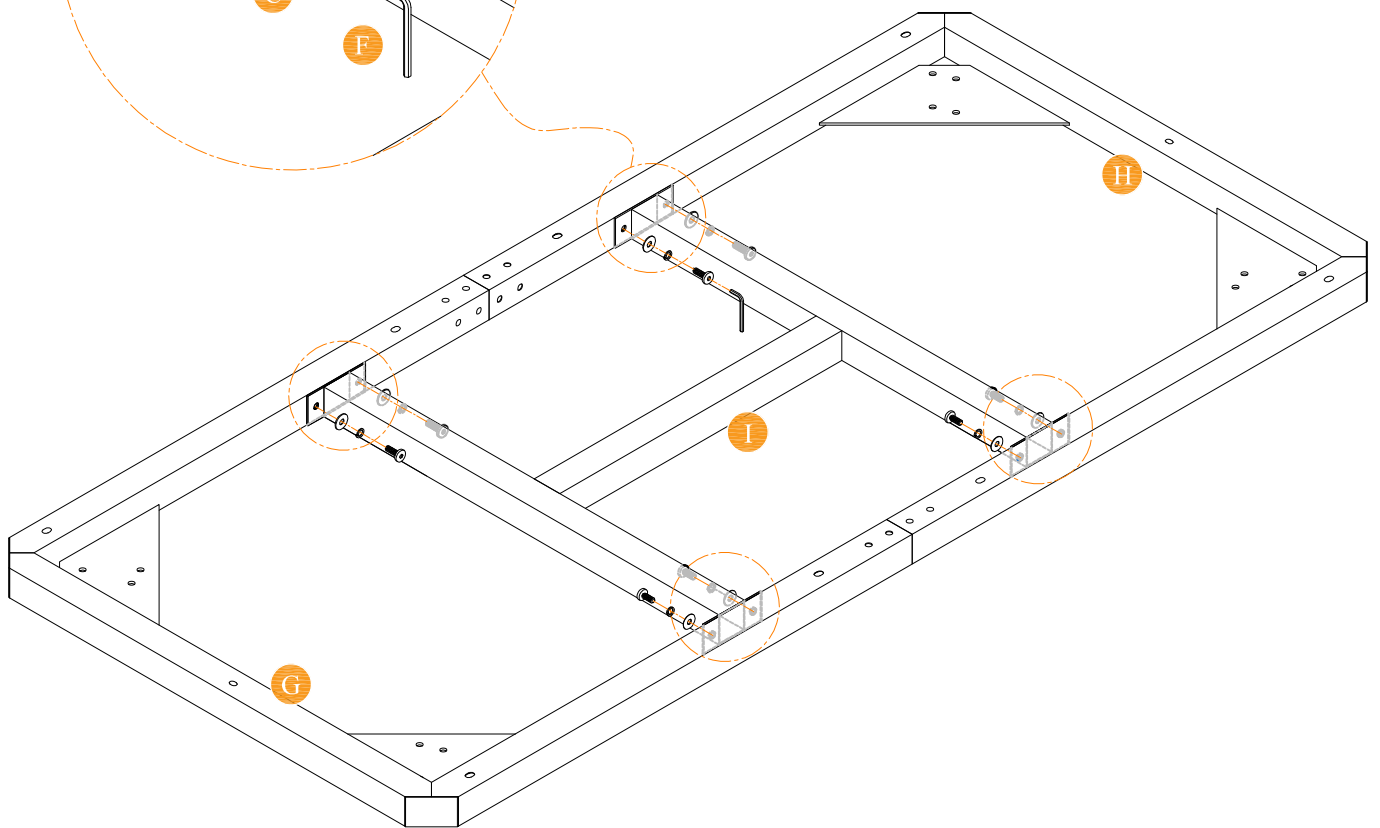
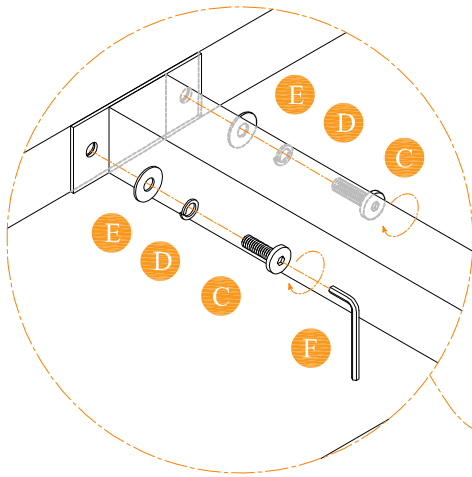

# ASSEMBLY INSTRUCTIONS

**STEP 2** Assemble the connecting piece.



(F) L-Wrench\*1



(C) Hex Head Screw  
M6X12mm \*16

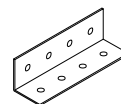

(J) iron bonding\*2



(D) Spring  
Washers\*16



(E) Flat Washers\*16

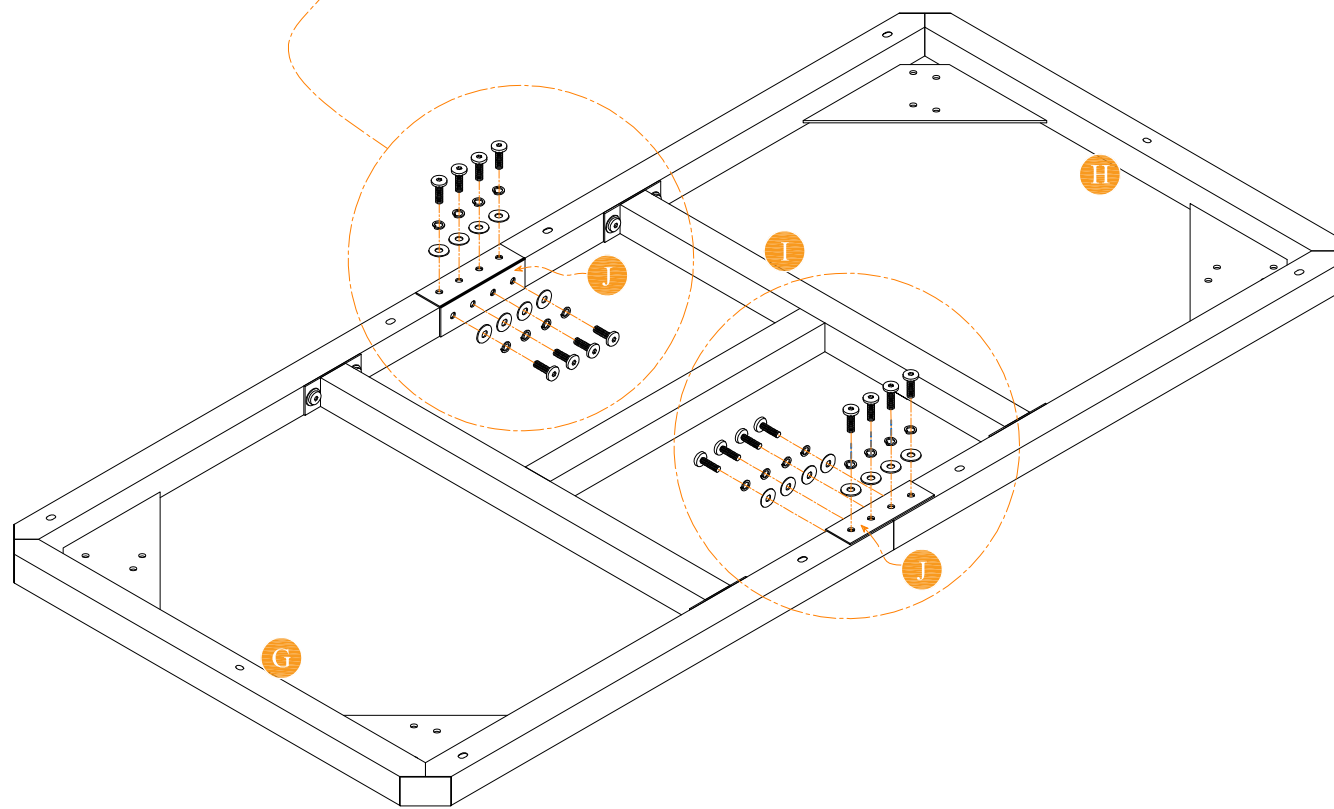
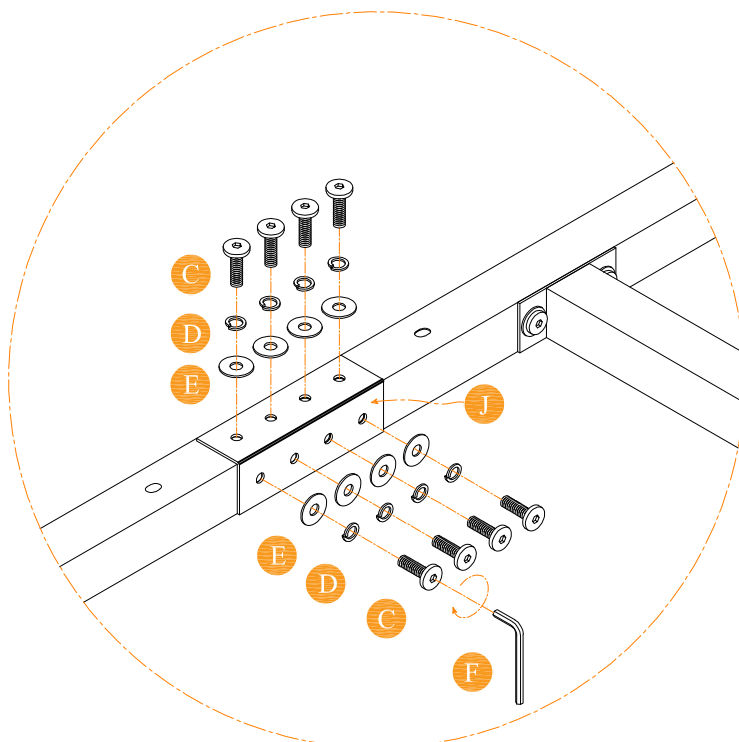

# ASSEMBLY INSTRUCTIONS

**STEP 3** Rotate frame 180° degrees.  
Stick the K-pad to the base of the table foot.



(K) Felt Disc \*4

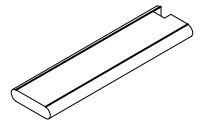

(2) Table legs\*4

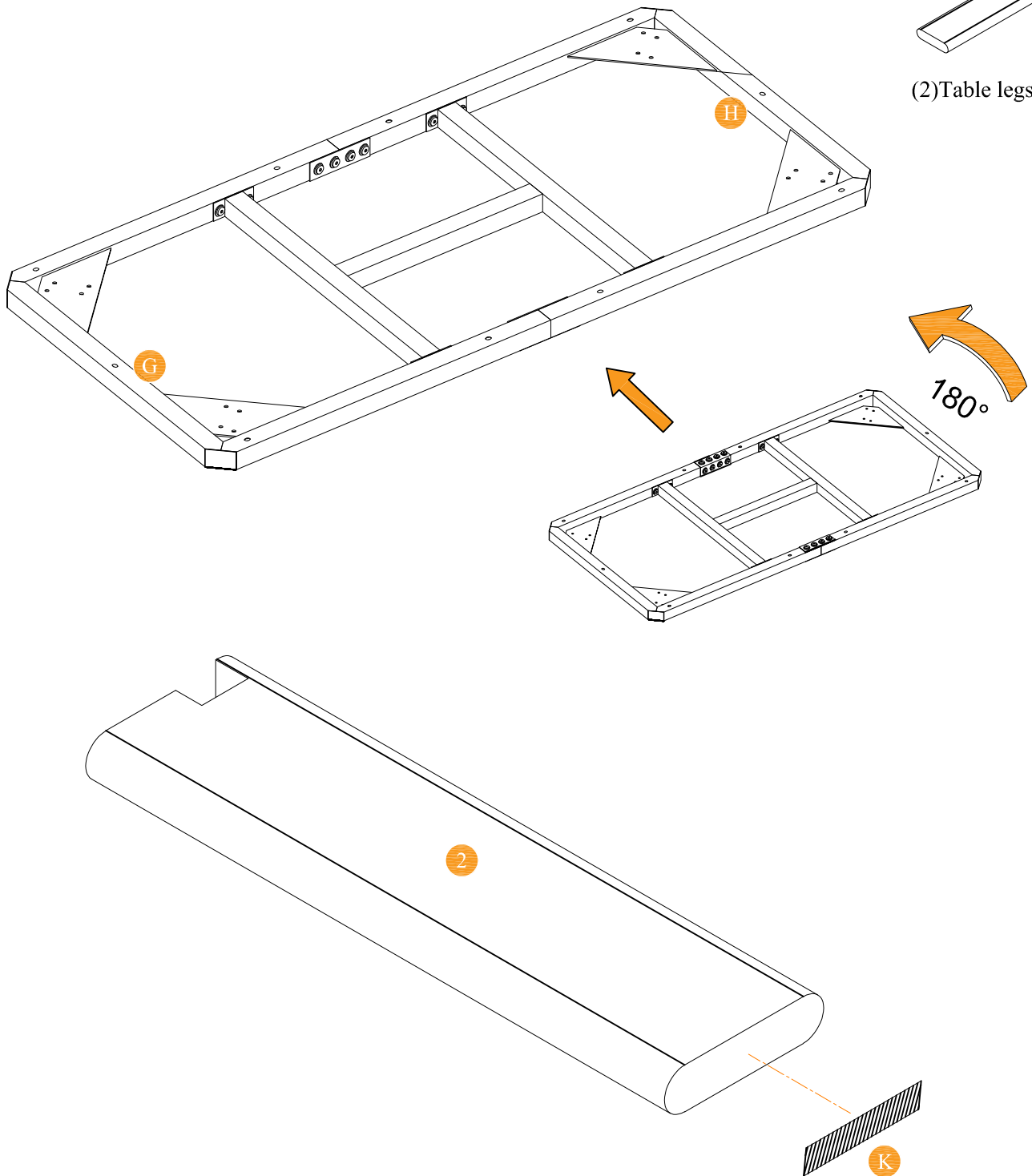

# ASSEMBLY INSTRUCTIONS

**STEP 4** Install four table legs.

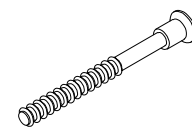
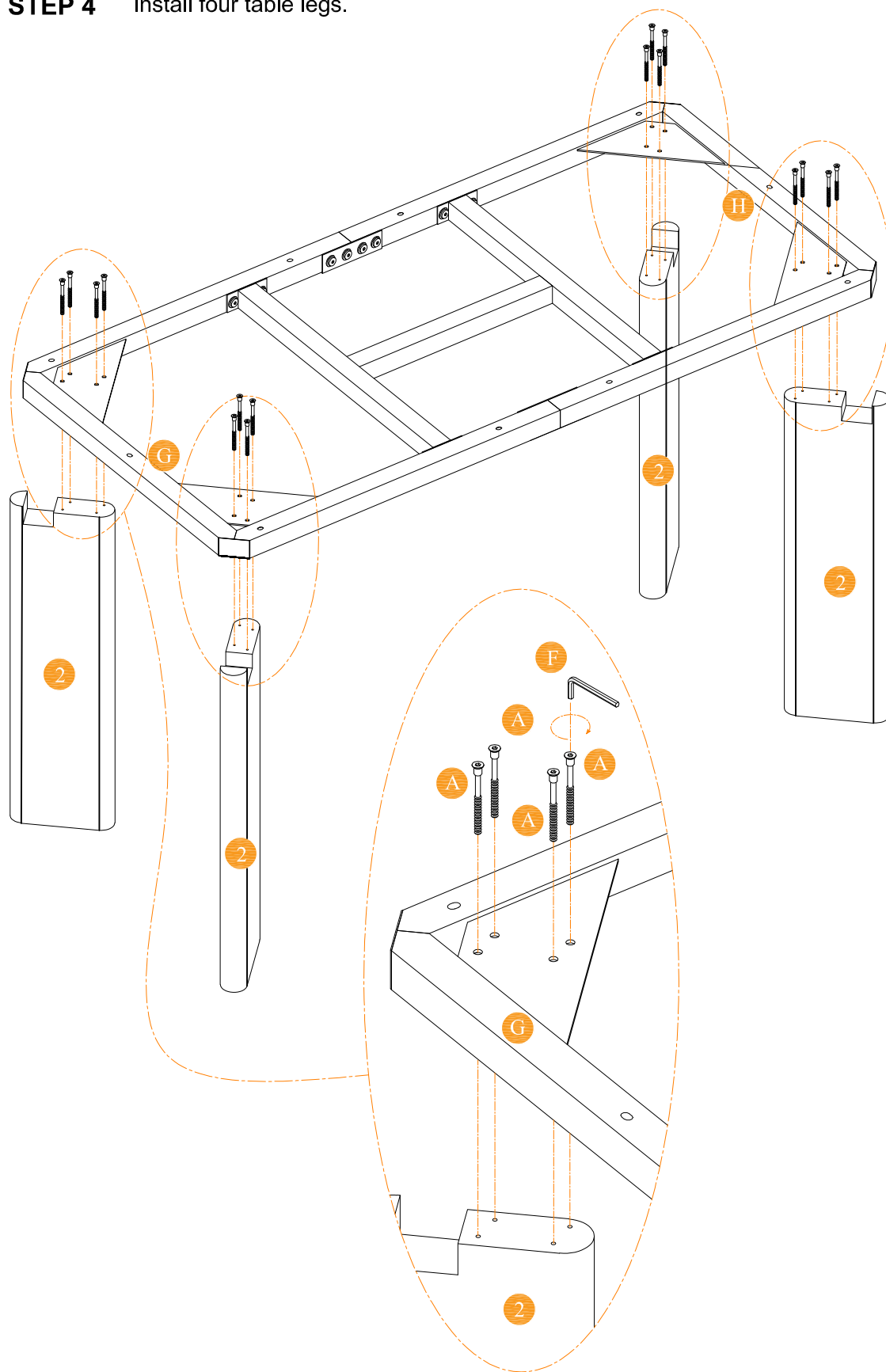

(A) Flat Head Screw  
M7x70mm\*16



(F) L-Wrench\*1

# ASSEMBLY INSTRUCTIONS

**STEP 5** Rotate frame 180° degrees.  
Install four table legs.



(F) L-Wrench\*1

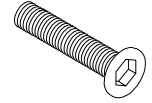

(B) Hex Head Screw  
M6X55mm \*10

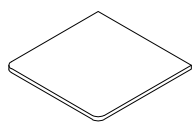

(1) Top panel\*2



(D) Spring  
Washers\*10



(E) Flat Washers\*10

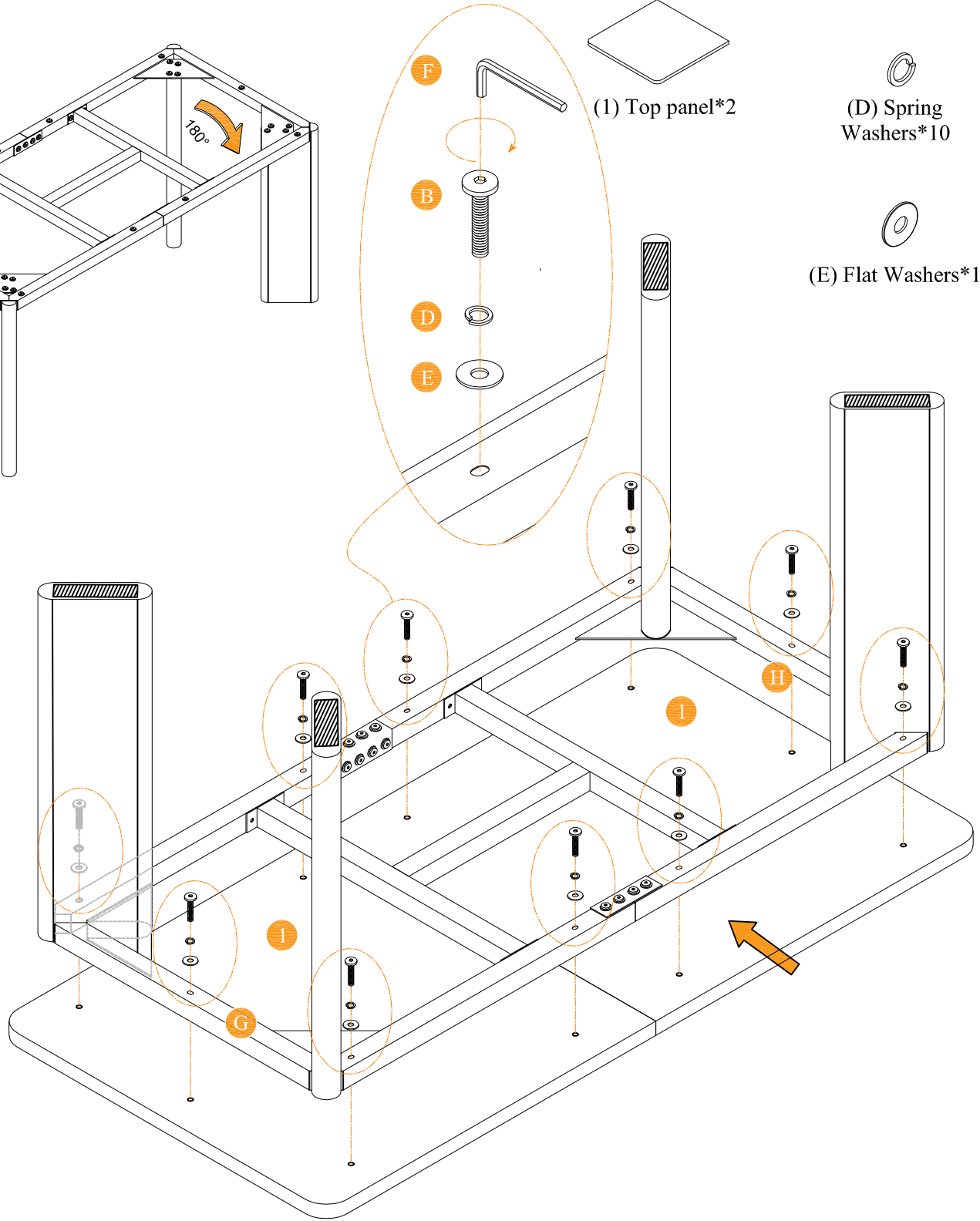
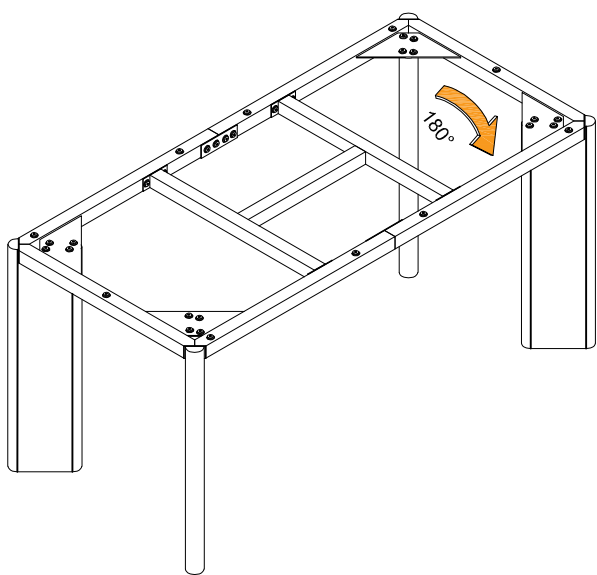

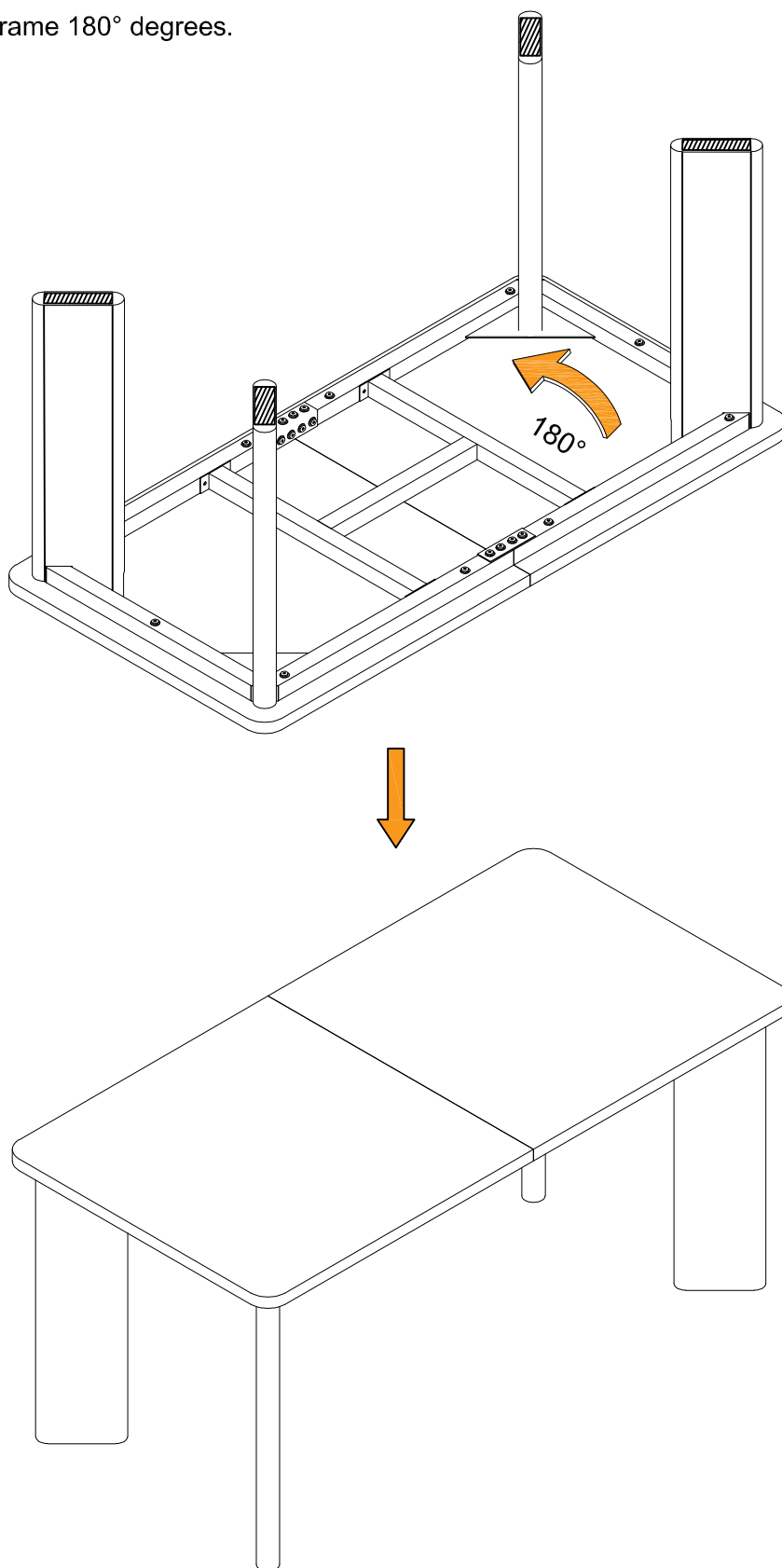
**ASSEMBLY INSTRUCTIONS****STEP 6** Rotate frame 180° degrees.

## LIMITED WARRANTY

We promise to repair or replace any product that is found to be defective in material or workmanship within one year from the date of original purchase, as long as you, the original purchaser, still own it. This is your sole and exclusive remedy under this warranty, subject to the provisions outlined below.

## EXCLUSIONS

This warranty does not apply to, and no other warranty applies to:

- Normal wear and tear, which is to be expected over the course of ownership.
- Misuse, abuse, or excessive use of the product.
- Modifications or attachments to the product that are not approved.
- Products that were not installed, used, or maintained in accordance with the product instructions and warnings.
- Products used for rental purposes or unauthorized retail activities.

Product Usage: Normal use is defined as equivalent to a single shift, forty-hour (40) workweek. If the product is used in a manner exceeding this, the applicable warranty period will be proportionately reduced.

## RETURN POLICY

We offer a 30-day return policy, meaning that all products purchased may be returned to us within that timeframe. You must contact us via email or customer service phone number within 30 days of receiving the product(s), and they must be returned to us without any undue delays.

### CONDITIONS:

- Returned products must be in the same condition as received and returned in their original packaging.

## LIMITED WARRANTY

- If the product is not faulty (i.e., if you change your mind or are unhappy with the product for another reason), you are responsible for the cost of return shipping. You must ensure the package arrives safely to us, so we recommend using a courier service that offers tracking.
- If the product is faulty when received, please contact us, and we will assist you with the return, covering the shipping costs in this case.
- We reserve the right to offer partial refunds for returned products that are not in unused condition, are damaged, or have missing parts not due to our error.

## HOW RETURNS WORK

To request a return, please attach a copy of your invoice as proof of purchase, along with the reason for the return.

We will provide the return address for the product as soon as possible. Once the returned product is received and inspected, we will provide a specific resolution.

If the return is approved, the refund amount will be automatically credited to your original payment method.

## MAINTENANCE INSTRUCTIONS



Dust and clean up spills immediately using a clean, non-colored, lint-free cloth.



For indoor use only. Do not place the furniture outside.



Do not place hot items directly on the furniture surface without using a protective barrier.



Do not place furniture near heating or cooling vents (keep at least 3 feet away)



Do not place furniture in direct sunlight.

TEL  
+1(888)868-6849

E-MAIL  
[malolservice@hotmail.com](mailto:malolservice@hotmail.com)

---

CAUTION: WE DISCLAIM ANY LIABILITY FOR DAMAGES OR INJURIES WHICH MAY OCCUR DUE TO FAILURE TO PROPERLY FOLLOW ASSEMBLY INSTRUCTIONS, PROPERLY ASSEMBLE THE PRODUCT, OR PROPERLY USE THE PRODUCT.