

***Tribesigns***

LITTLE TREE

# Assembly Instructions

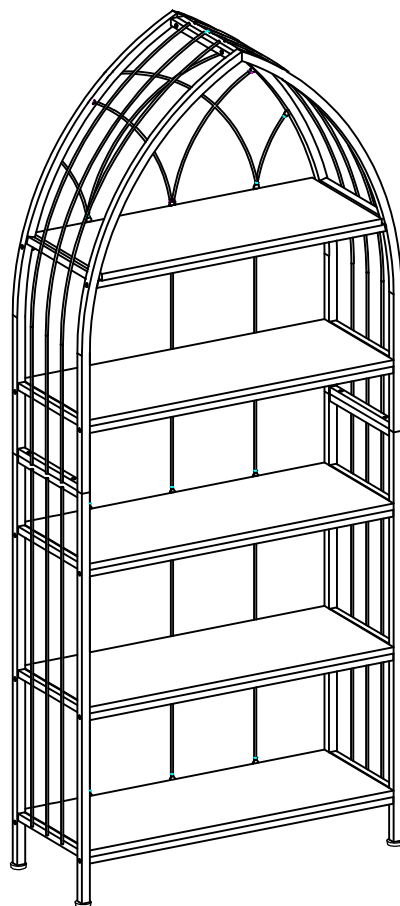

Model No. HOGA-F1868

Bookshelf

# Call us!

## We're here to help!

If you have any issues with this product, please contact our customer service team **before returning** it.



We want you to be completely satisfied with your purchase! If anything is missing, damaged, incorrect, or not what you expected, don't worry. Please keep the outer packaging and take photos of both the packaging and products, and then reach out to us at **support@tribesigns.com** or call us at **1-424-220-6888**. We'll take care of everything and send you a free replacement, so you can enjoy your purchase as soon as possible without any hassle.

### Assembly Instructions:

1. Carefully read these instructions and keep them for future reference.
2. Refer to the parts list for guidance and ensure that you have all the pieces before starting the assembly process, if anything is missing, damaged, incorrect, contact us **FIRSTLY BEFORE** assembling.
3. When assembling, place all parts on a soft, clean, and flat surface, such as a carpet, to prevent any scratches.
4. To avoid misalignment of the holes, Please don't full tighten the screws until you ensure all parts in place.

---

### Follow Tribesign:



Facebook



Twitter



Pinterest



YouTube



Instagram

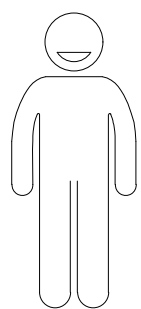

x1

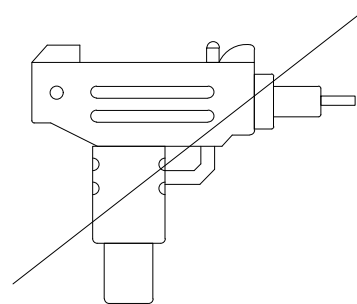
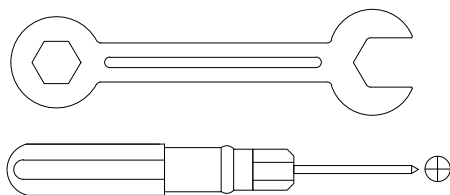

When using the electric screwdriver ,  
Reduce the power and torque to avoid damaging the furniture

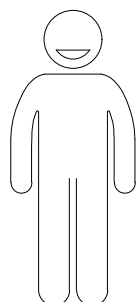



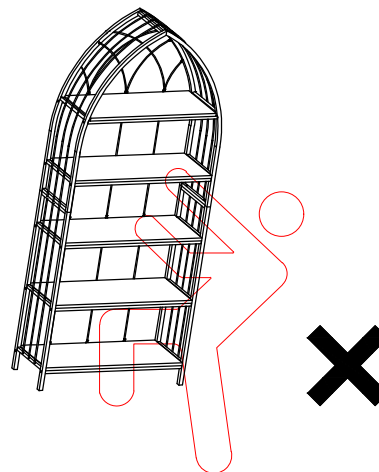
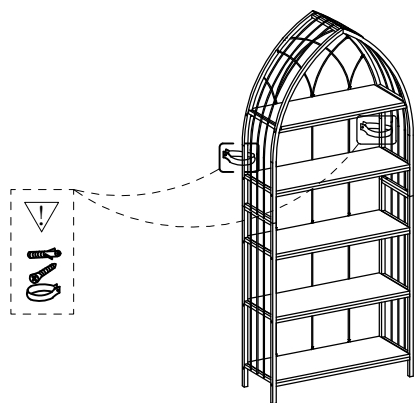
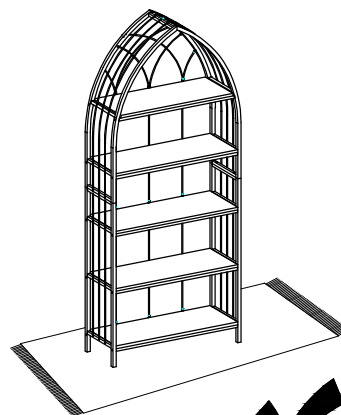
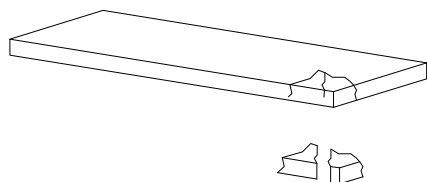
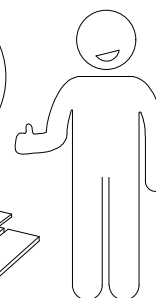
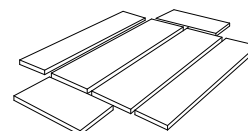
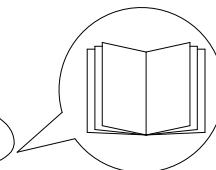
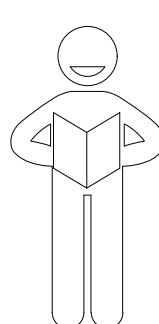
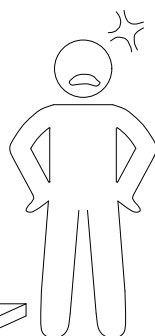
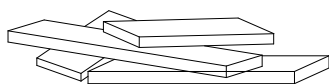

?

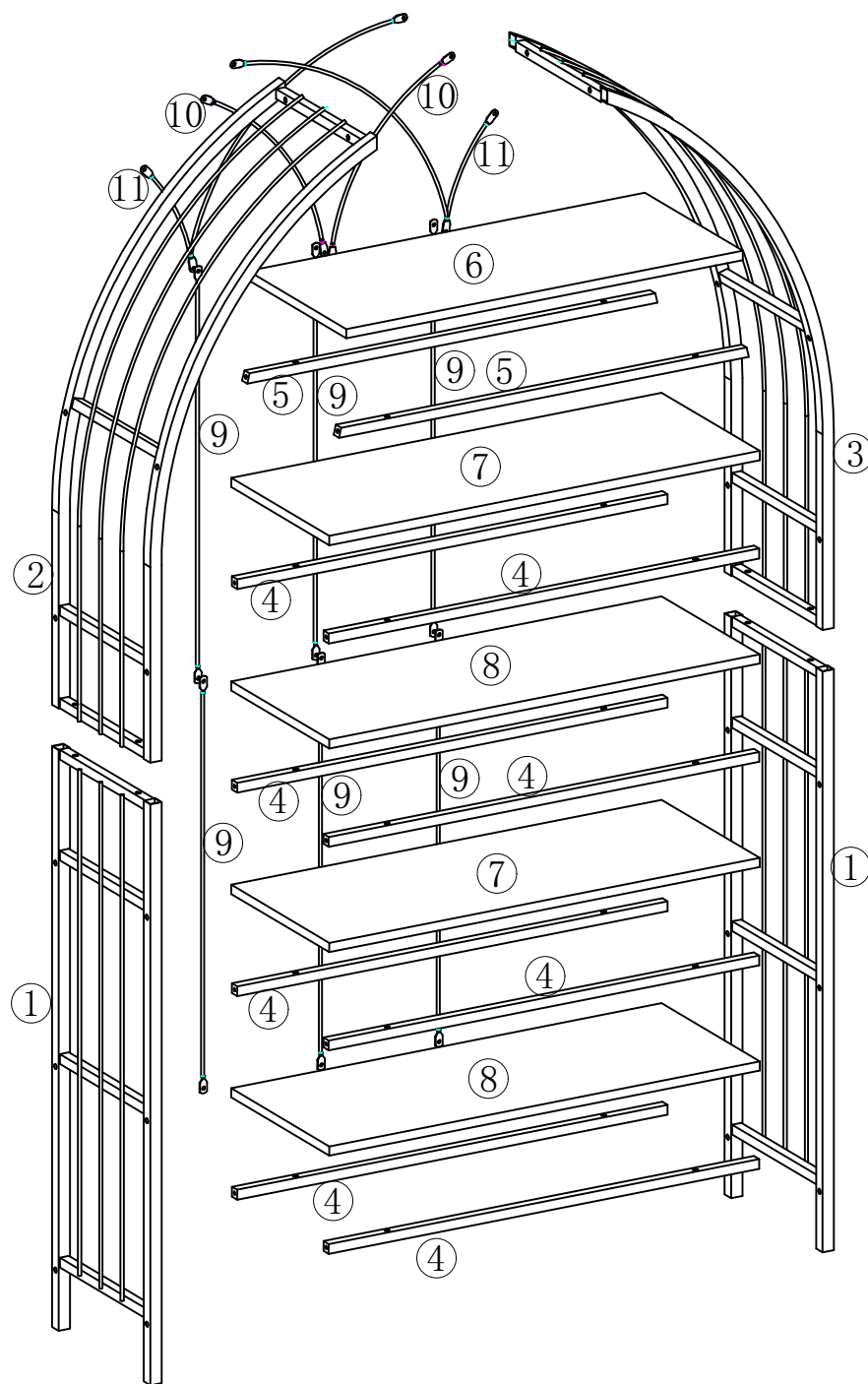

5) Use the provided tip-over restraint during installation  
(The use of tip-over restraints may only reduce  
but not eliminate the risk of tip-over.)

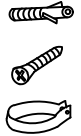
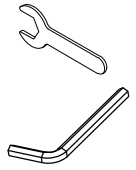

<p><b>A</b></p>  <p>x4</p>	<p><b>B</b> M6×40mm</p>  <p>x26</p>	<p><b>C</b> M6</p>  <p>x6</p>	<p><b>D</b> M6×25mm</p>  <p>x20</p>
<p><b>E</b> ST3.5×15</p>  <p>x15</p>	<p><b>F</b></p>  <p>x2</p>	<p><b>G</b></p>  <p>x1</p>	

1

X2

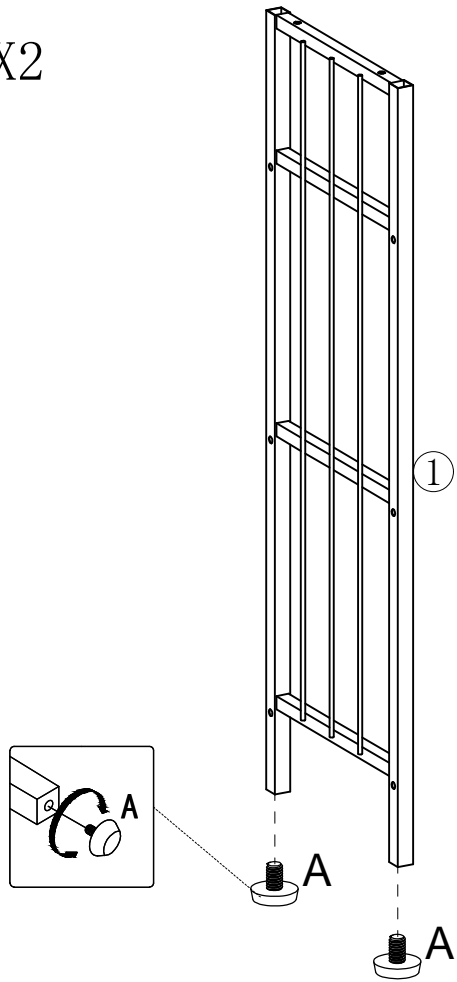

A

x4

2

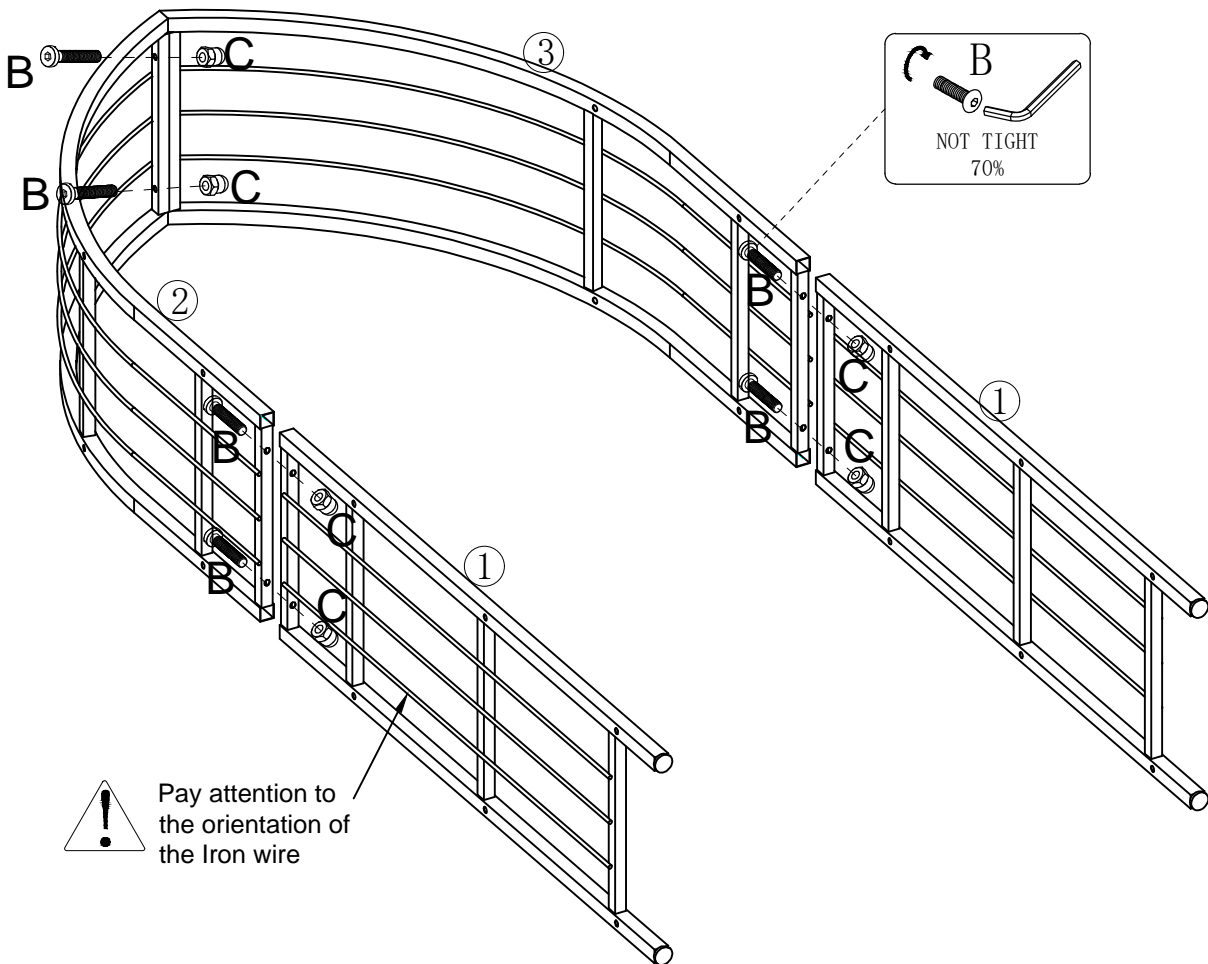

B

NOT TIGHT  
70%

C M6

x6

B M6x40mm

x6

! Pay attention to the orientation of the Iron wire

3

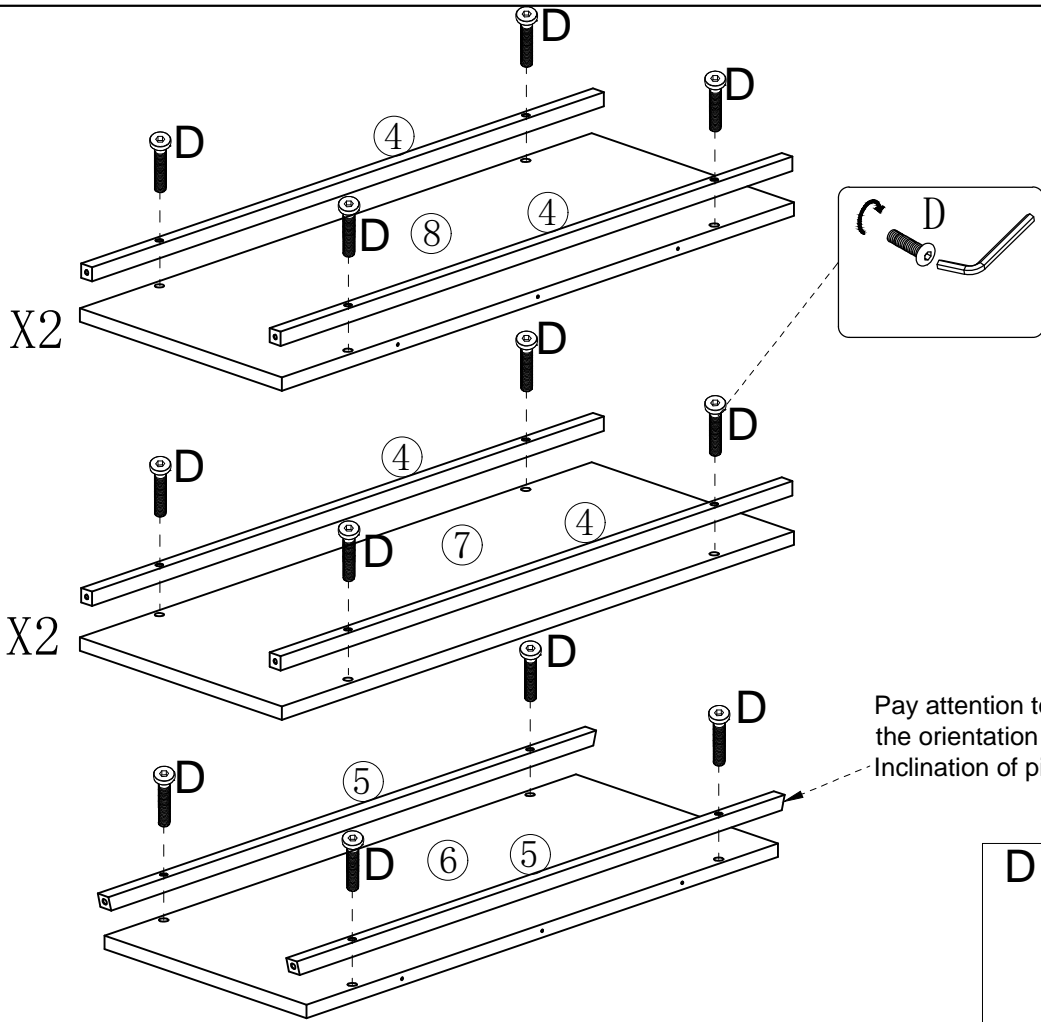

4

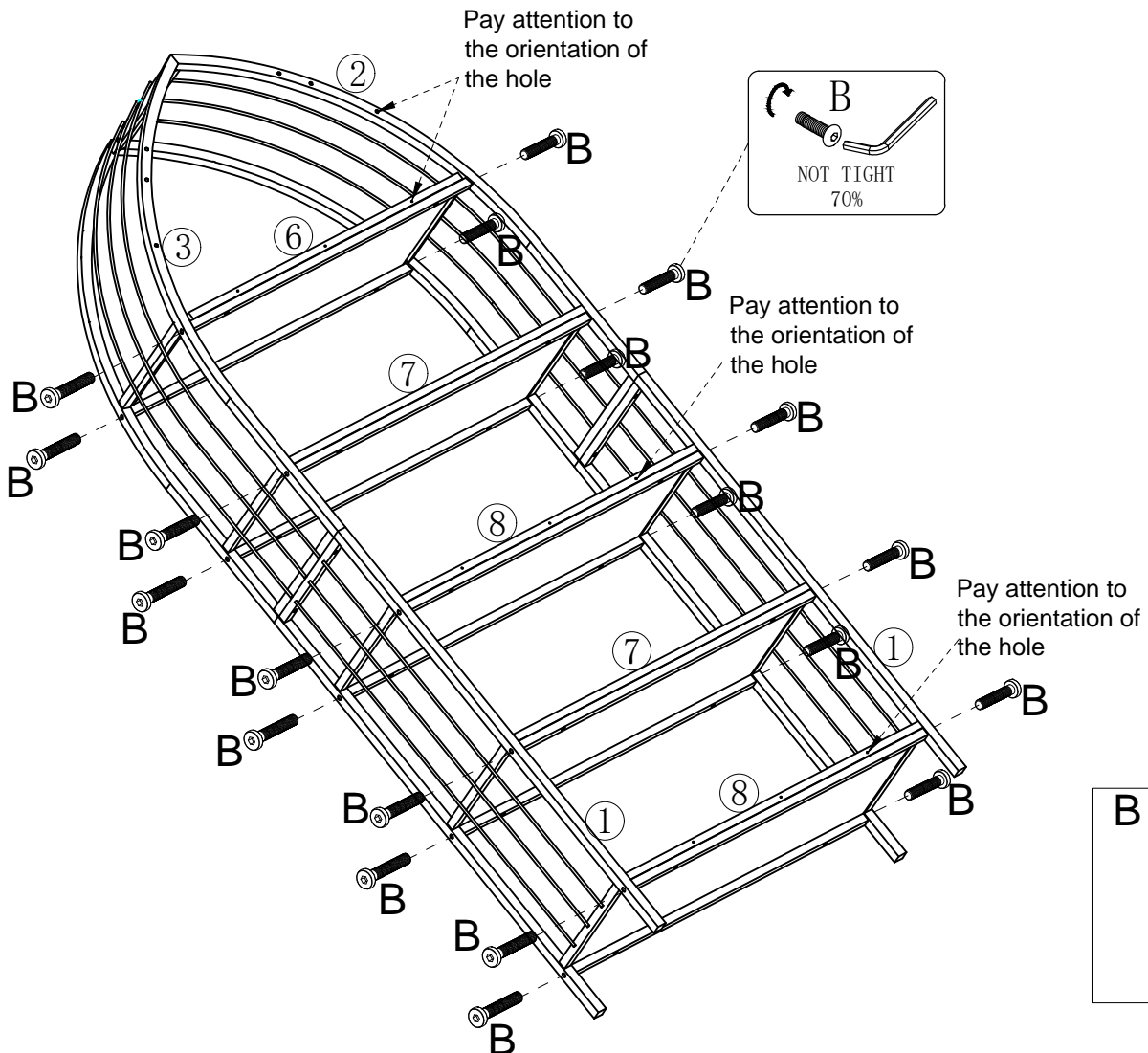

5

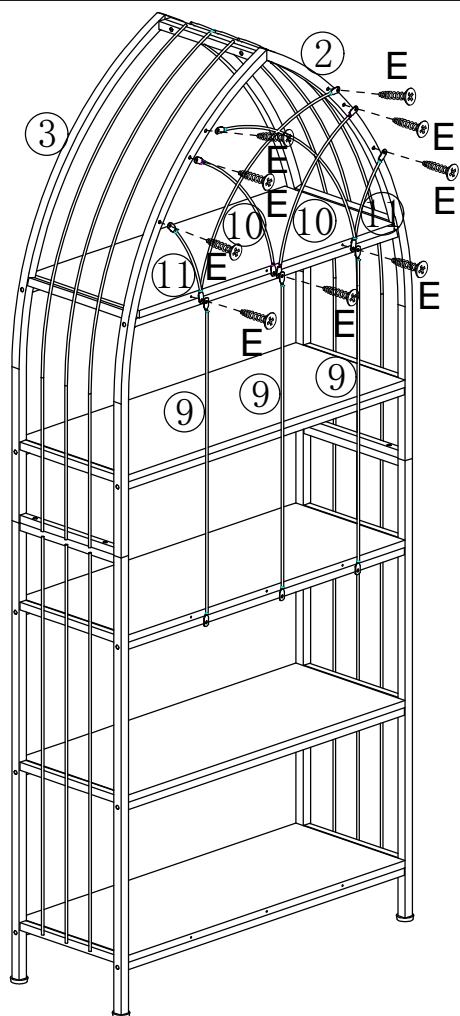

E ST3.5×15



×9

6

TIGHT ALL SMCREW 100%

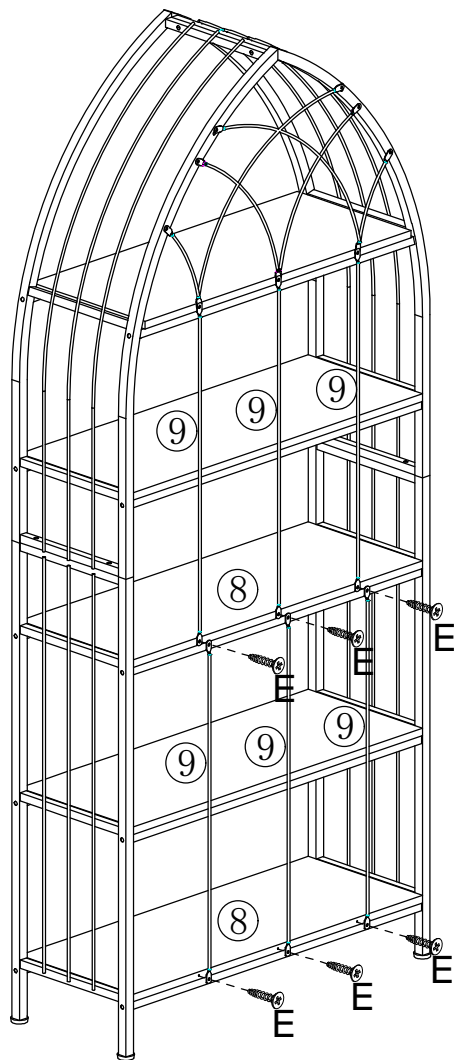

E ST3.5×15



×6

7

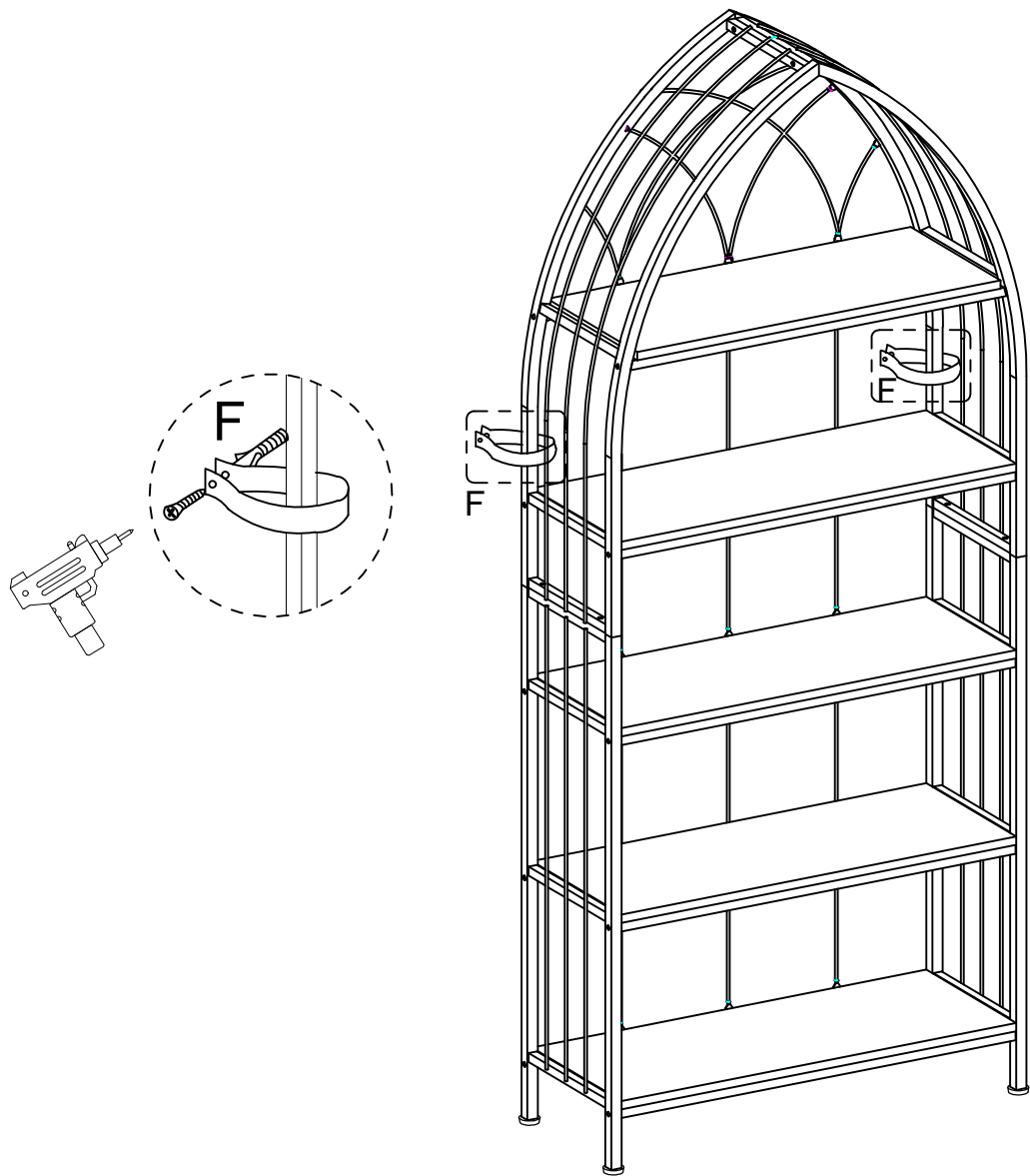

F

×2

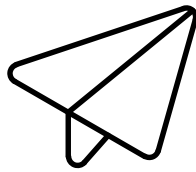

# No heartburn, when we handle the return

## Our way



support@tribesigns.com



Replacement/Refund



You

## Their way

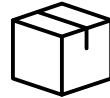

Re-package item



Schedule pick-up

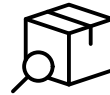

Track package



Replacement



You

Contact our customer service team



support@tribesigns.com  
www.tribesigns.com



1-424-220-6888