

ASSEMBLY INSTRUCTION

Friendly Reminder:

- 1.This sofa is packed in 5 boxes. Please assemble it After all boxes are received.
- 2.As the cushions are all vacuum compressed,there will be some wrinkles. Please give your cushions up to 72 hours to reach its original size and the wrinkles will basically disappear.
- 3.Please do not open the compressed packags until your sofa frame is completely assembled.

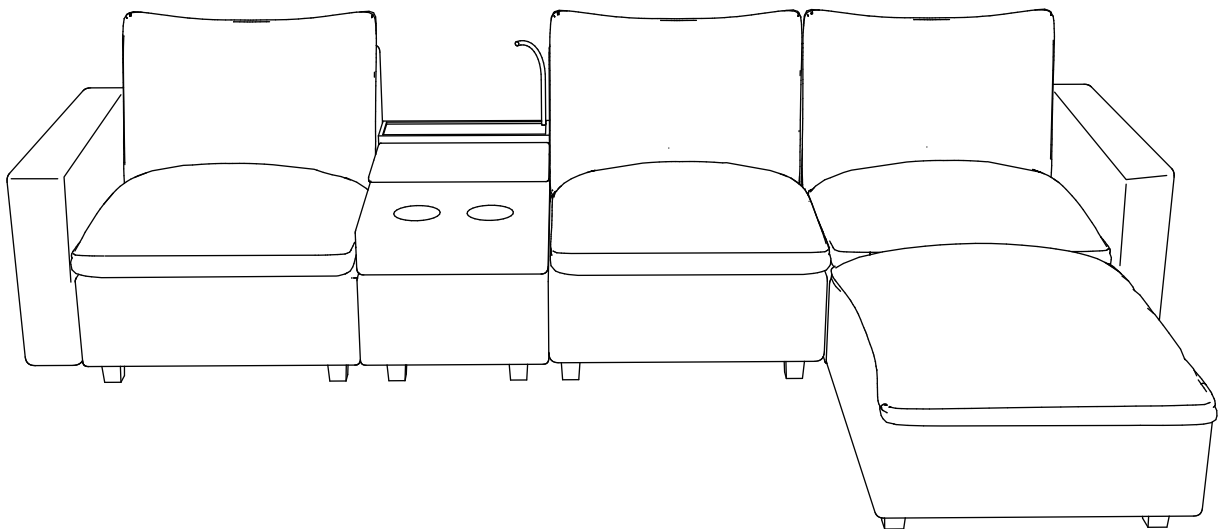







Return & Warranty policy:







- We strive to offer the highest quality products,and we also try our best to satisfy each and every customer that orders from us with replacement parts or service as needed.
- If the item is damaged or defective, please take photos as evidence for replacements and refunds.
- Please do not return to store,contact the seller if you have any troubles with this product.

ASSEMBLY INSTRUCTION

PARTS LIST





NO	DESCRIPTION	SKETCH	QTY
A	Left Armrest		1
B	Left seat frame		1
H	Back frame		1
I	Back cushion		1
J	Seat cushion		1
L	Leg		4

PARTS LIST





NO	DESCRIPTION	SKETCH	QTY
N	Right Armrest		1
D	Right seat frame		1
H	Back frame		1
I	Back cushion		1
J	Seat cushion		1
L	Leg		4

ASSEMBLY INSTRUCTION

PARTS LIST



NO	DESCRIPTION	SKETCH	QTY
F	Console		1
G	Power Box		1
L	Leg		4
M	Power cable		1

PARTS LIST

NO	DESCRIPTION	SKETCH	QTY
C	Middle seat frame		1
H	Back frame		1
I	Back cushion		1
J	Seat cushion		1
L	Leg		4

ASSEMBLY INSTRUCTION

PARTS LIST

NO	DESCRIPTION	SKETCH	QTY
E	Ottoman frame		1
K	Seat cushion		1
L	Leg		4

All parts and hardwares

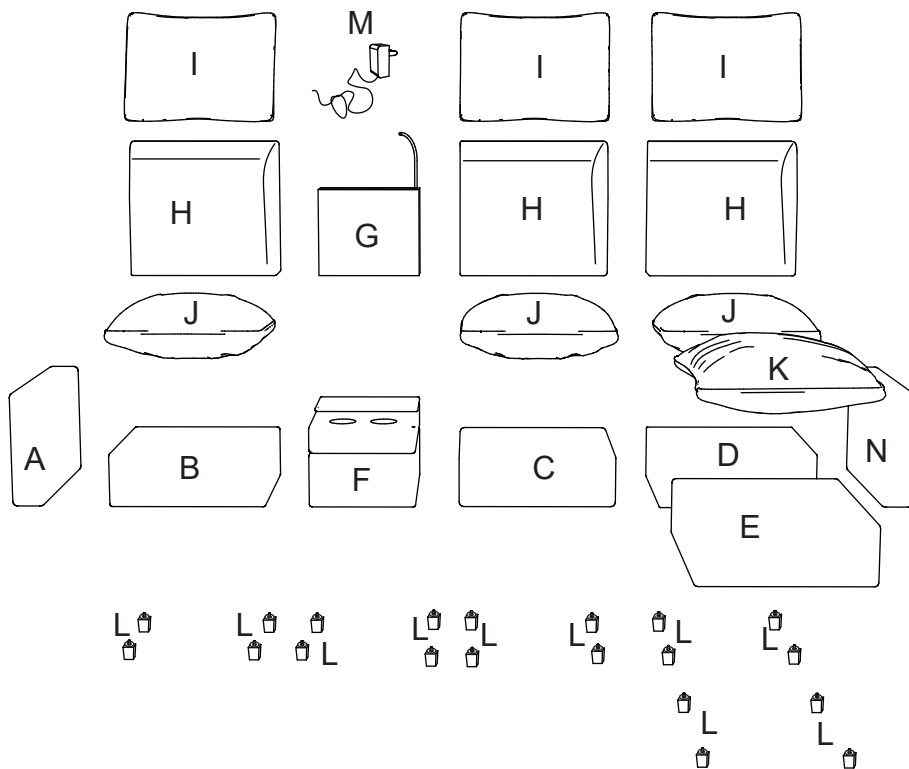

DIAGRAM 1

Connect the 20 Plastic Legs with the Seat frame (Parts B C D E) and the Console (Part F).

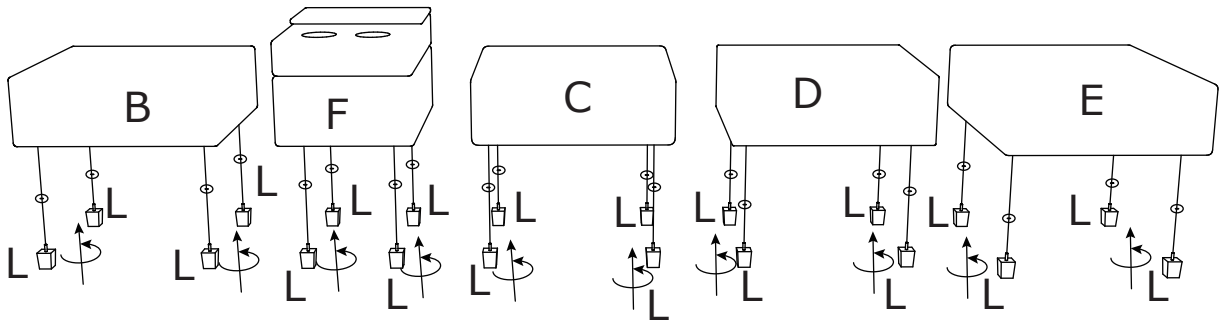

DIAGRAM 2

Connect part B, part F, part C, part D together.

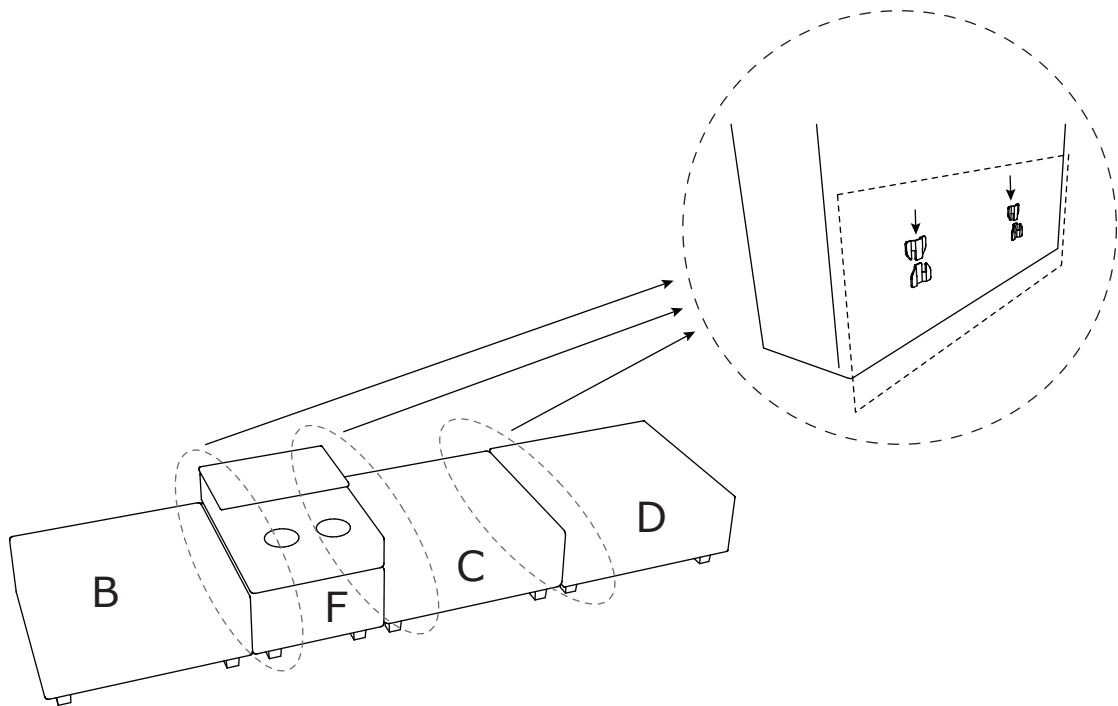

DIAGRAM 3

Connect part A and H to part B.
Connect part N and H to part D.
Connect part G to part F.
Connect part H to part C.

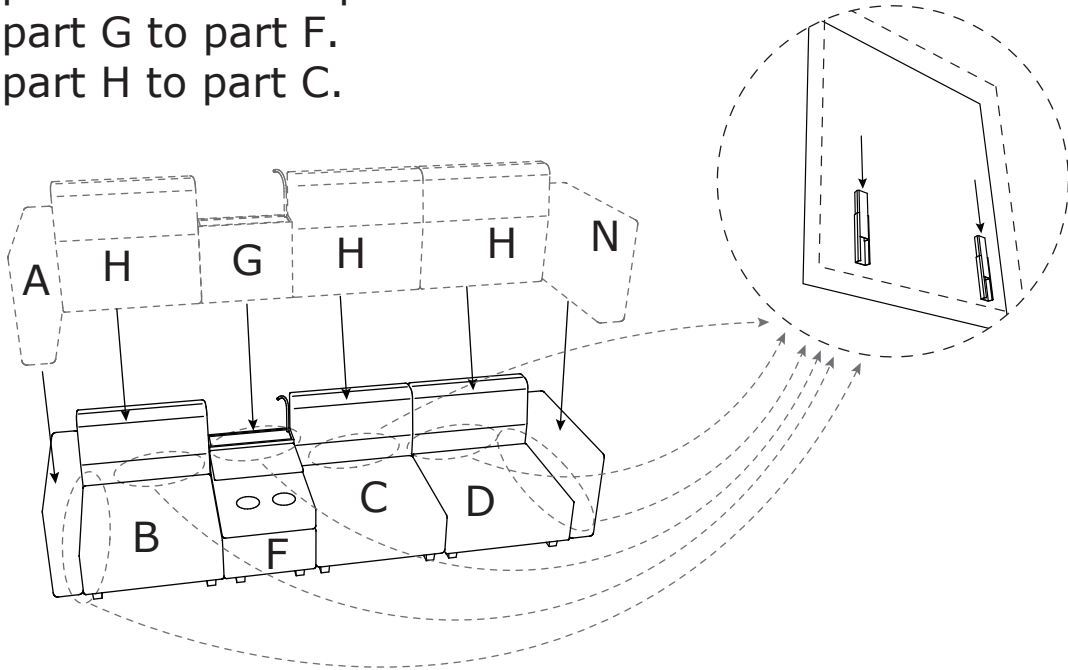

DIAGRAM 4

Connect power cable part M to part G.

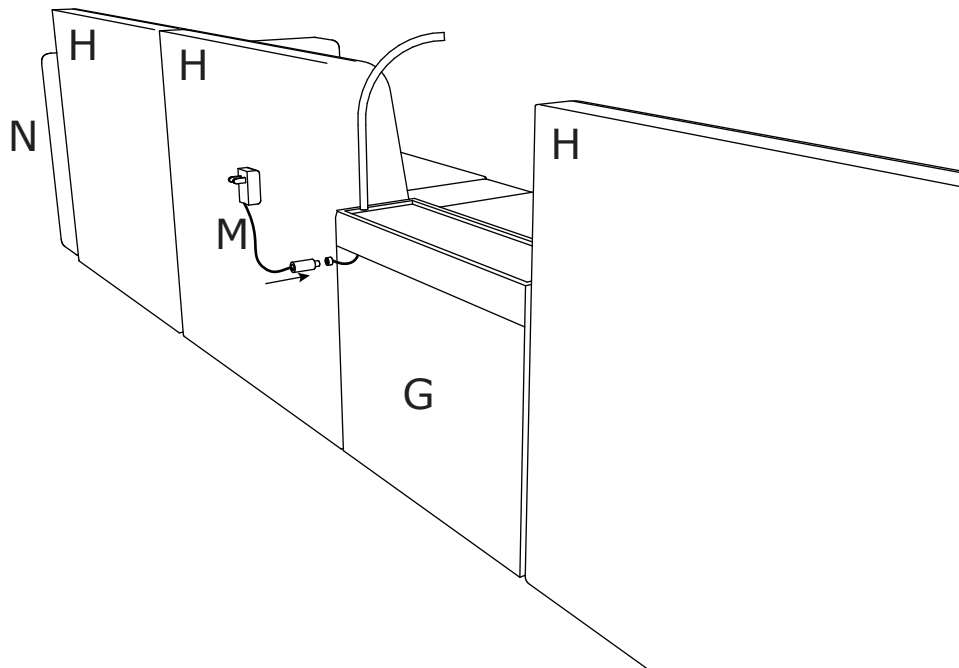
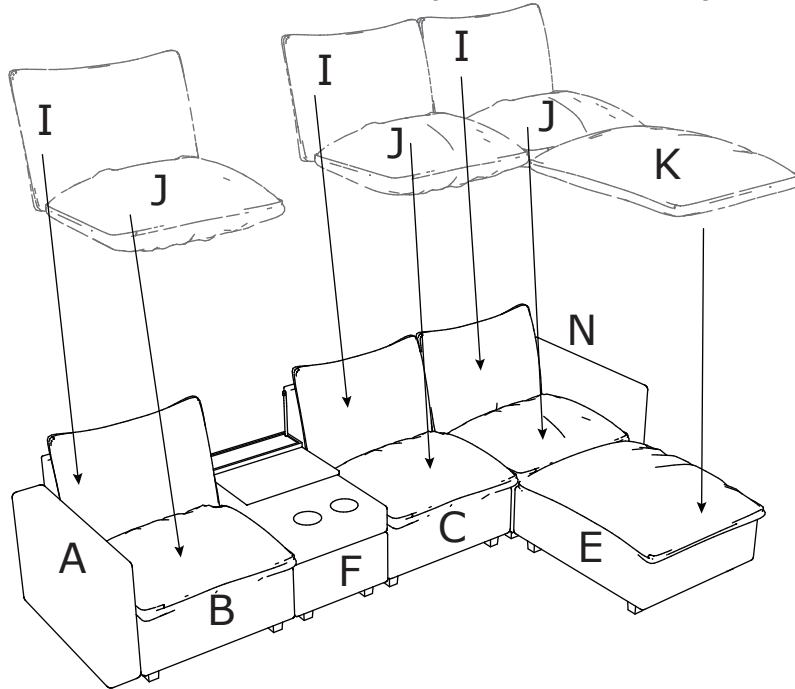
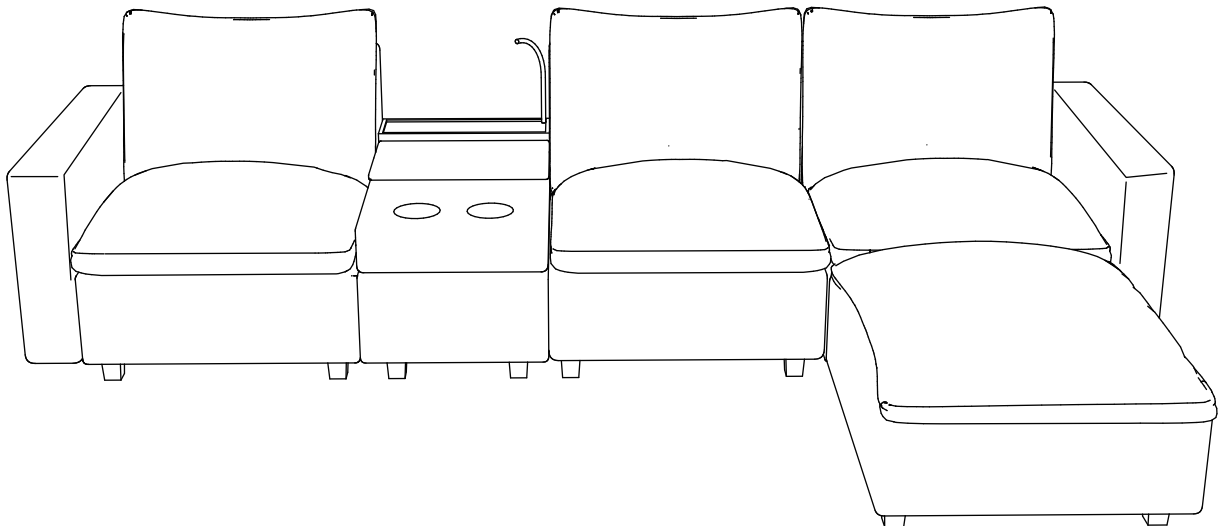

DIAGRAM 5

Put the cushion part J and part K on the sofa, put the Back cushion part I on the sofa. Recheck all the parts before you sit on the sofa.



DONE



1. Open the zipper at the bottom of Part F, loosen the cord, take Part G Part L and Part M out.

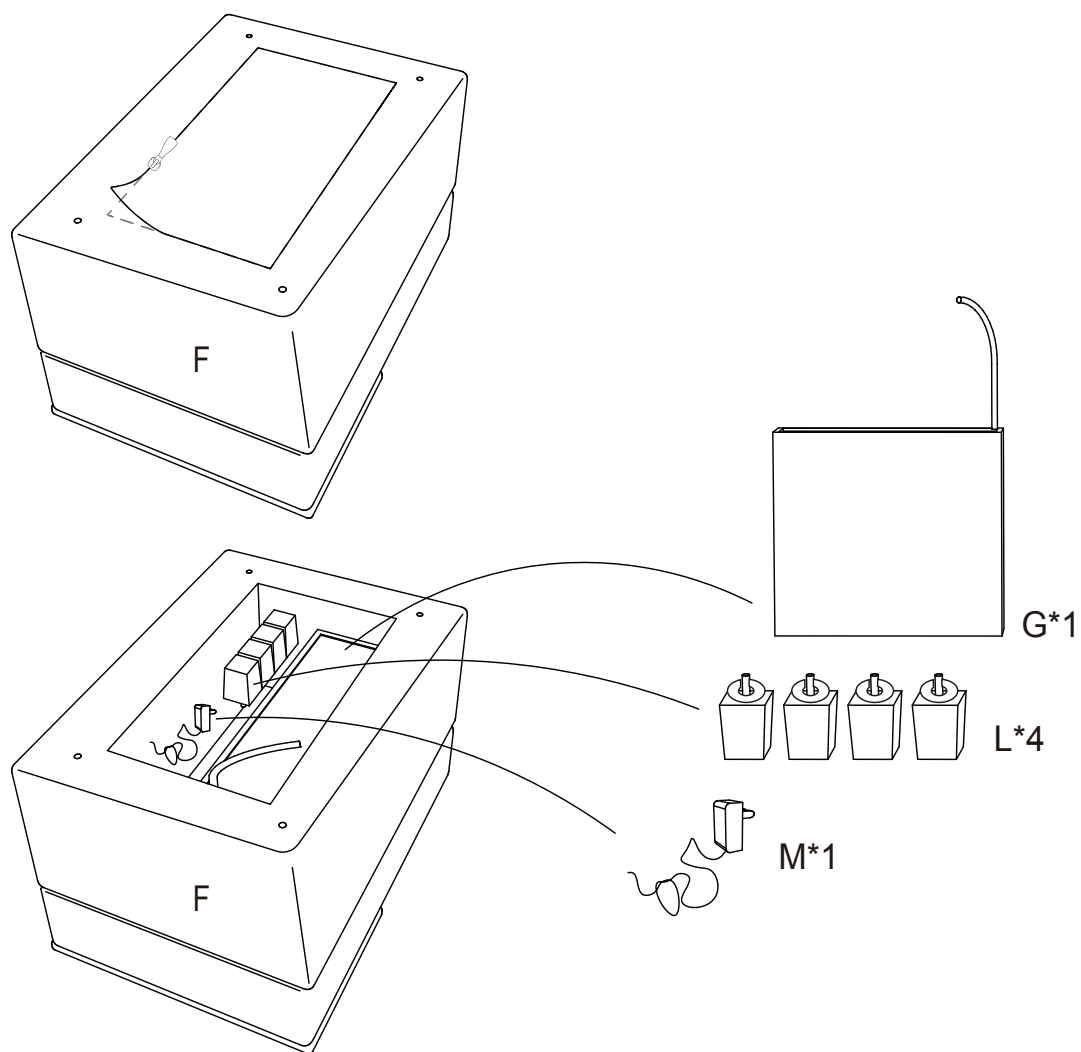

2. Zip up the zipper and screw the legs Part L to Part F, connect Power cable Part M to Part G.

