

# PREPARATION

Before beginning the assembly of the product, make sure all parts are present. Compare the parts with the package contents list and hardware contents list. If any parts are missing or damaged, do not attempt to assemble the product. Tool required for assembly (included): Allen Key.

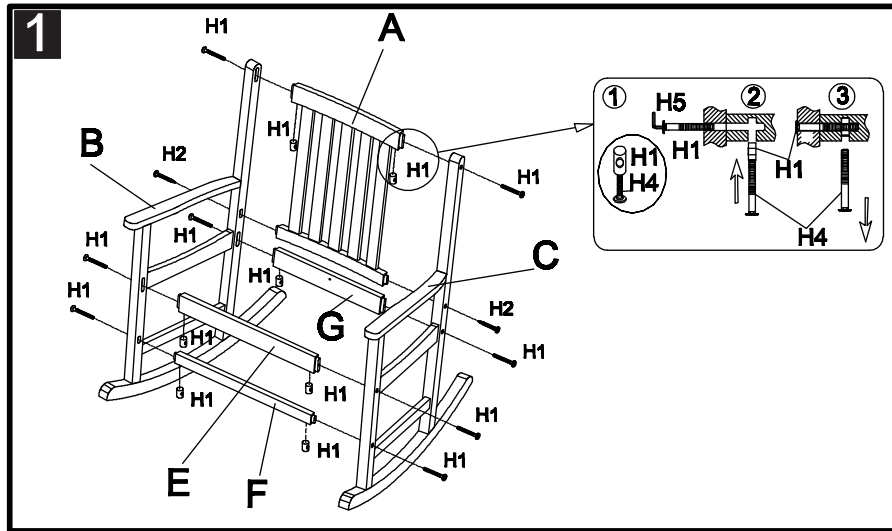

Step 1: attach the left side (C) and right side (B) to the back (A) by using Allen nut (H1) and Allen screw L (H2) as shown on the picture. Tighten with the Allen Key (H5). Make sure to tighten all positions before continue step 2.

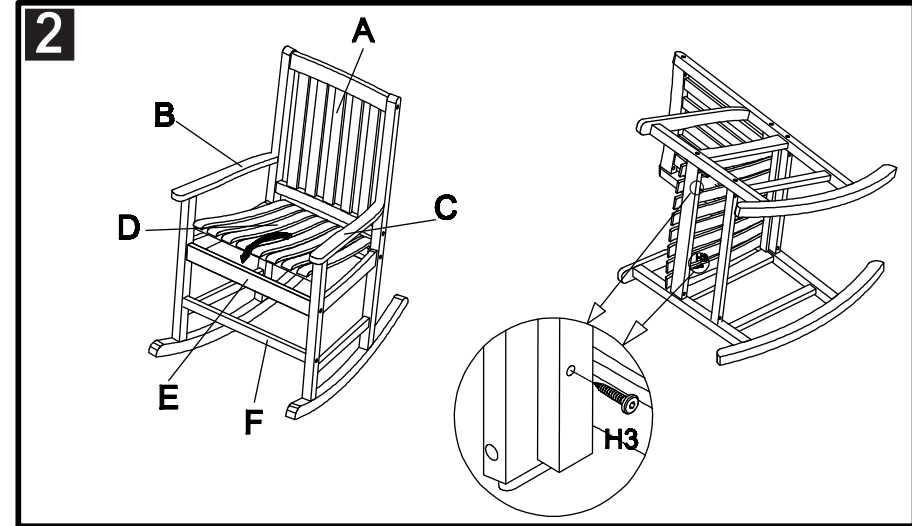

Step 2: put the seat (D) to the chair as shown on the picture and using the Allen screw S (H3) to fit.

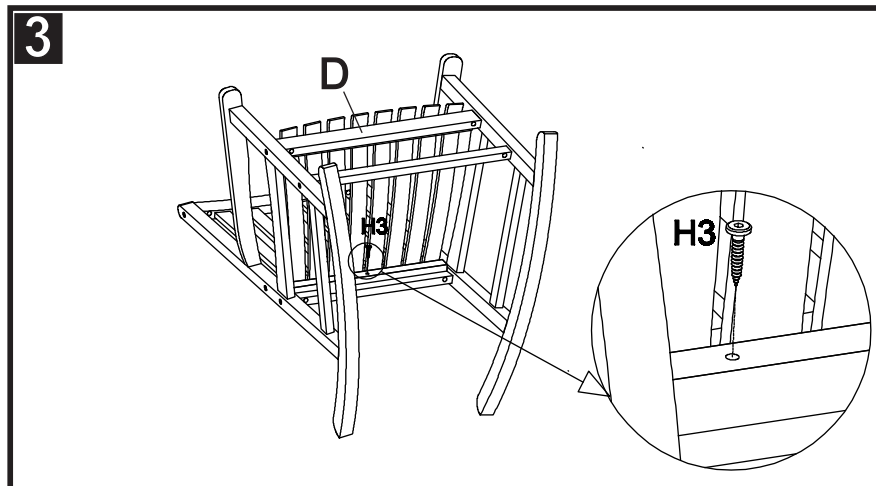

Step 3: continue to use Allen screw S (H3) to fit the seat (D) to the chair by using the Allen key (H5) as shown on the picture.













## CARE AND MAINTENANCE

Store outdoor furniture indoors or cover well when it is not in use. Dust regularly with small brush or vacuum. Spills should be taken care of immediately before they harden or stain with a slightly dampened sponge.

## NOTICE

Please make sure that you have all parts indicated before you begin assembly of this item.

### Part List and Hardware List

PIECE	DESCRIPTION	PICTURE	QUANTITY
A	Back		1 X
B	Left side		1 X
C	Right side		1 X
D	Seat		1 X
E	Support seat		1 X
F	Support leg		1 X
G	Support S		1 X
H 1	Allen nut M6x60		8 X
H 2	Allen screw L M6x60		2 X
H 3	Allen screw S M6x35		3 X
H 4	Extra bolt M6x50		1 X
H 5	Allen Key		1 X

Product Dimension: 25.2"W x 31.1"D x 40.16"H

Weight capacity : 300 lbs

Warning : Do not stand on the chair

Warning : Do not torque bolts / screws

