

MULTI-FUNCTION MASSAGE CHAIR WITH LIFT, HEAT & USB, 2 Cup holders



LIFT CHAIR MODEL #L8777A51

ASSEMBLY INSTRUCTIONS

GENERAL INFORMATION, TIPS & TRICKS

1. Please read this instruction prior to assembling this product.
2. To avoid damage, assemble this product on a non-abrasive surface such as carpet.
3. This product is intended for residential use only. Commercial applications are not permitted.
4. Please make sure you have all parts before assembly.

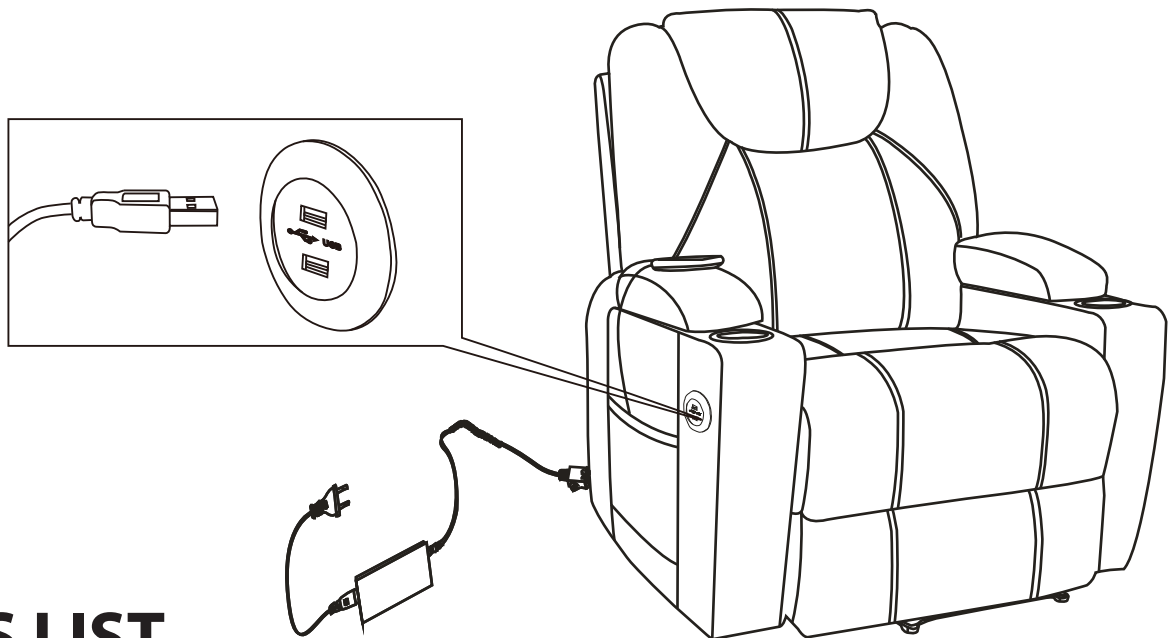

PARTS LIST

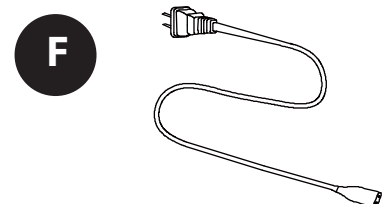
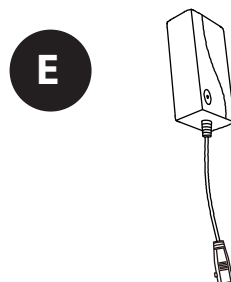
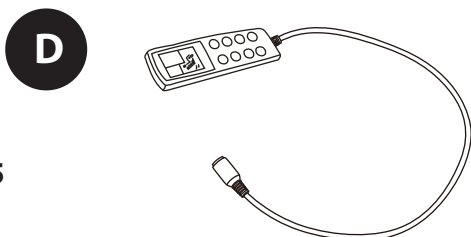
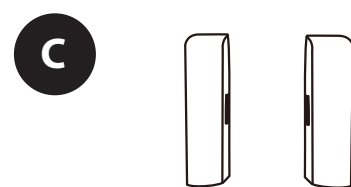
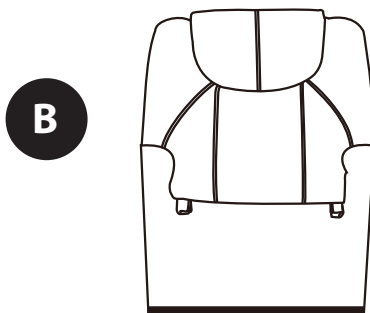
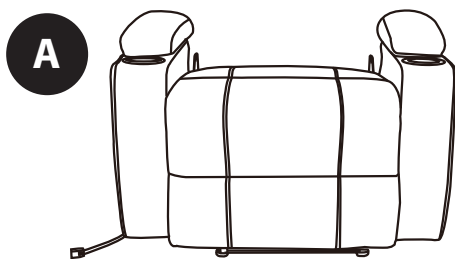

Step 1

Locate the transformer (E) & wire plug (F) and remote control (D) secured to the hinge bracket of the seat.

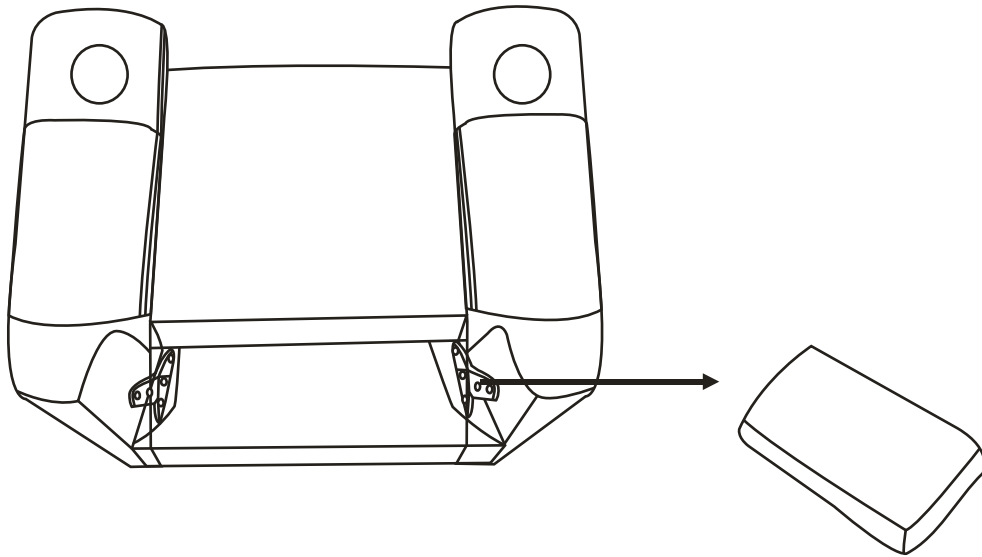

Step 2

Attach backrest (B) to main frame (A) by aligning the metal grooves on backrest to brackets on the main frame as shown.

Ensure the backrest (B) slides down fully over the brackets on the main frame (A) and firmly press down to secure in place.

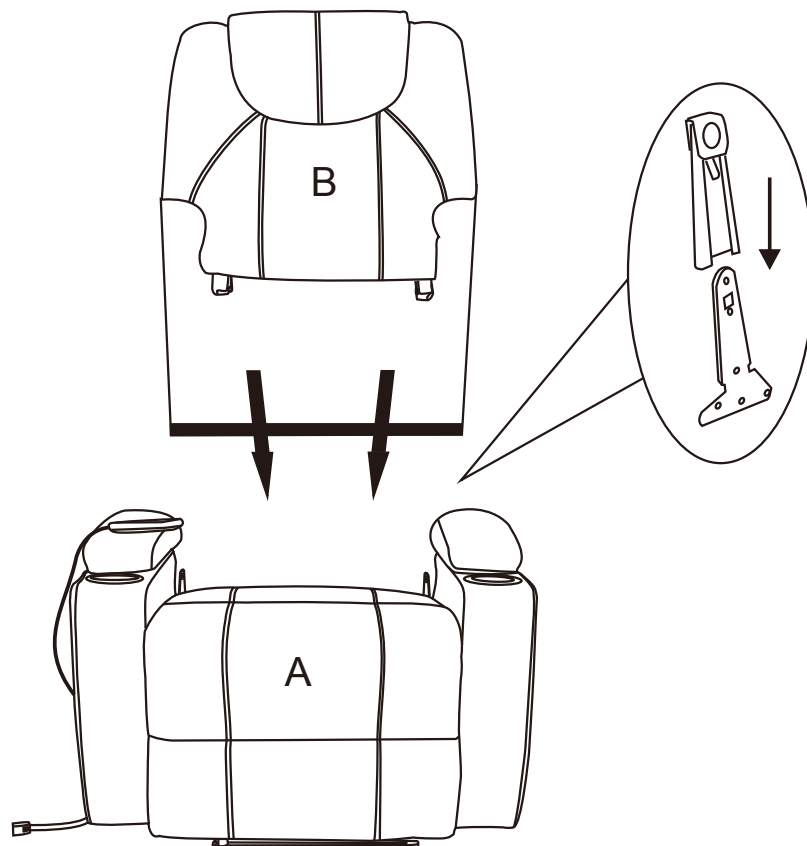

Step 3

- A. Connect the two wires attached to backrest (B) with wire plugs attached to the seat (A) according to the corresponding plug type.
- B. Connect the remote control to the corresponding plug located **INSIDE** the seat pocket.

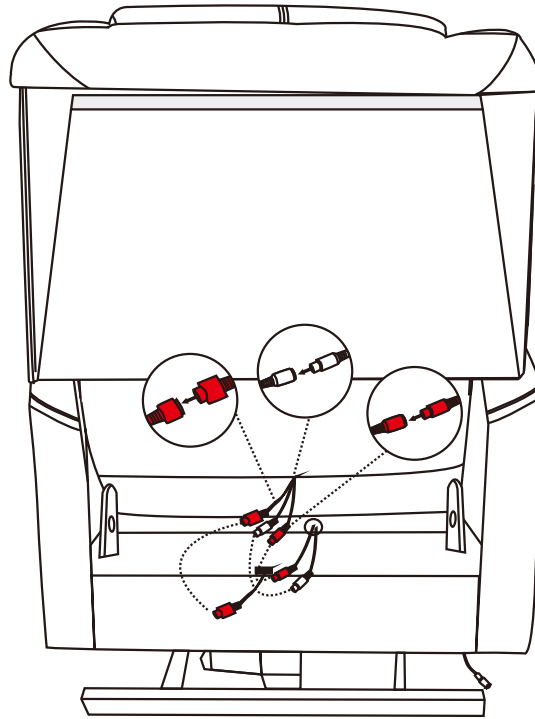

Step 4

Attach the transformer (E) to the plug on the back of seat (A). Connect the transformer (E) with the wire plug (F) and then turn on the electricity. Use the provided adhesive strip to close the backrest panel.

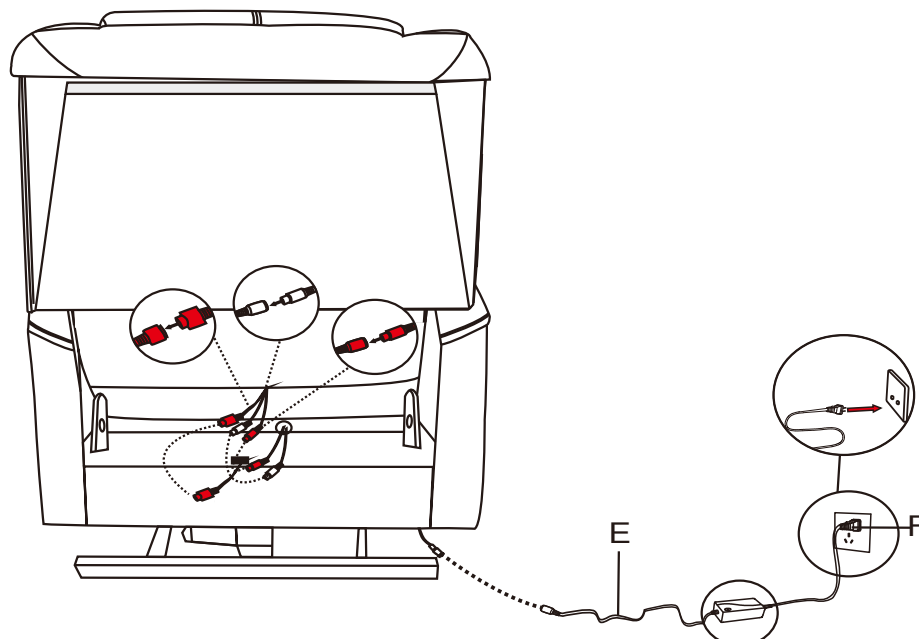

Step 3

Attach the chair bolsters (C) to the back sides (B) by aligning the metal grooves on each side.

Make sure to slide the bolsters (C) down fully and press firmly to secure in place.

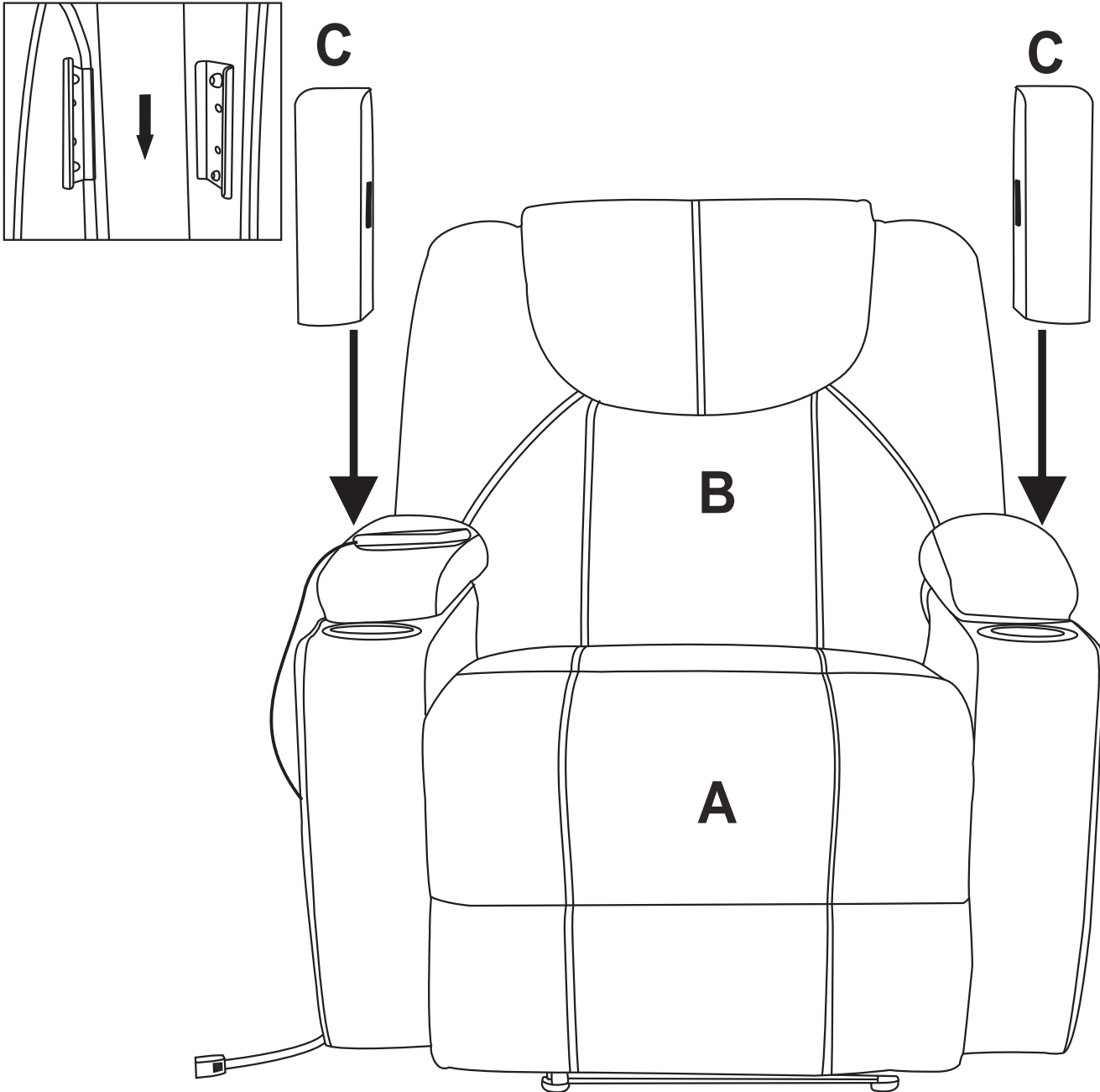

REMOTE CONTROL



- 1. Massage Mode Indicator
- 2. Massage Zone
- 3. Operation Keys

- 4. Timer Indicator
- 5. Intensity Indicator
- 6. Heating ON/OFF Indicator

OPERATING INSTRUCTIONS

- Press **POWER** to start the massage. Click to button massage modes 1 through 6 .The unit will power off in 15 minutes unless changed.the unit's default intensity is set to 2 unless changed.
- Press **POWER** to **POWER OFF** the unit.
- Press **HEAT** button to ENABLE OR DISABLE heating function.
- Press **POINT** button to cycle between massage areas such as back, thighs, legs or buttocks. The # indicator light will illuminate on the remote control.
- Press **MODE** modes adjustment button , auto, gentle, wave, squeeze, tap, knock, click on the button.
- Press **TIMER** to set the power off timer up to 30 minutes in 5 minute increments. Default operation time is 15 min.
- Press **INTENSITY** button on the remote control to cycle the massage intensity. The indicator strength on the remote control **||||||** will increase from 1 to 3 in one level increments
- Press and **HOLD UP** or **HOLD DOWN** to recline or lift the chair.



**HOLD DOWN BUTTON
TO RECLINE**



**HOLD UP BUTTON
TO LIFT**

WARNING INFORMATION

- To prevent the chair from tipping over, gently sit down on the chair and avoid throwing yourself onto it. Move the chair into the reclining position slowly, making sure that no children or pets are in close proximity.
- Do not allow children to play on or around the chair, particularly when it is in the reclined position.
- Close the recliner completely before standing.
- Never sit on the footrest when it is extended.
- To eliminate the risk of tip over, do not sit on the arms or footrest.
- The chair is designed to be used by a single adult at a time.
- Maximum bearing weight is 300 lbs.
- Prevent the following people from using this chair: People with severe symptoms of heart disease, high blood pressure, cerebral thrombosis and any people who are sensitive to heat, or people with bad bones, pregnant women, children, and other people who is not suitable to use this product. This is not a medical device.
- To fully recline the chair a minimum distance of 40 inches from the wall or any obstacle directly behind the chair is required.
- Keep any open flames away from the product.
- Keep sharp objects such as knives, nails, etc. away from the product.
- Prevent water and liquids from the chair to avoid damage such as staining or discoloration to the material and fabric of the chair.

CLEANING & SPECIAL CARE

1. Avoid collision when moving the chair. Move the chair carefully.
2. For light stains spot treat the chair using an approved cleaner or mild detergent. **DO NOT USE SOAPY WATER or WAX based cleaners.** Using a sponge carefully wipe away stains and dry with a soft cloth.
3. To avoid discoloring do not place the unit in direct sunlight or in the direct path of an air conditioning vent.

1 YEAR LIMITED WARRANTY

The manufacturer warrants this unit against defects in materials and workmanship on functional parts, for a period of 1 year from the original date of purchase. Your sales receipt showing the date of purchase of the product is your proof of purchase. Keep it in a safe place for future reference. This warranty is subject to personal use only, commercial or rental applications will not be covered.

This product is made with the highest quality materials and is warranted to be free from defects in materials and workmanship at the time of purchase. This limited warranty applies to products manufactured or distributed by the manufacturer, are delivered in the continental United States or Canada and extends to the original purchaser, or gift recipient. This warranty becomes valid at the time of purchase and terminates either by the specified time frame listed above and/or owner transfer. Any refunds or monetary compensations must be claimed through the place of purchase (retailer), and not through the manufacturer. Any extended warranties (warranties that cover above and beyond this manufacturer warranty) that are sold through a retailer or third party, are not directly correlated with this products' limited warranty, and may be redirected to said retailer or third party for coverage.

This warranty extends through the manufacturer of the product, and covers functional parts only. Cosmetics are not covered, unless unequivocally determined it is a workmanship defect. Shipping damage should be addressed with the shipping company, retailer, or place of purchase, not the manufacturer unless the manufacturer was the direct shipper.

The manufacturer's sole obligation under this warranty shall be limited to furnishing the original purchaser replacement parts for units deemed repairable by the supplier's warranty department. The purchaser is responsible for insuring any parts shipped or returned, if desired. The purchaser is responsible to prepay any shipping charges (both ways) including, but not limited to taxes and duties. All exchanged parts and products replaced under this warranty will become the property of manufacturer. The manufacturer reserves the right to change manufacturers of replacement parts or products for use, in order to cover any existing warranty. The purchaser may be asked to provide the supplier with proof of purchase documents (including the date of purchase) if requested. Any evidence of alteration, erasing, or forgery of proof of purchase documents will be just cause to VOID this limited warranty. Products, in which the serial number has been defaced or removed are not eligible for warranty coverage.

This warranty does not apply if the unit has been subject to negligence, fabrication, misuse, abuse, or repairs, alteration by non-manufacturer authorized personnel, inappropriate installations, or any case beyond the control of the manufacturer. Examples of warranty invalidation may also include, but are not limited to:

- Outdoor applications
- Normal wear/tear/weathering including but not limited to fabric stains / peeling.
- Pet/consumer accidents
- Purchases from dealers unauthorized by the manufacturer (Authorization in writing)

The manufacturer shall not be liable for any loss due to use (or misuse) of the unit or other incidental or consequential costs, expense or damages without irrefutable foundations. Under no circumstances shall the manufacturer or any of its representatives be held liable for injury to any person or damage to any property, however arising. Any implied warranty shall have duration equal of the applicable warranty stated above. Specifications are subject to change without notice or obligation.

This limited warranty gives the original purchaser specific legal rights. Other rights may vary from state to state.