

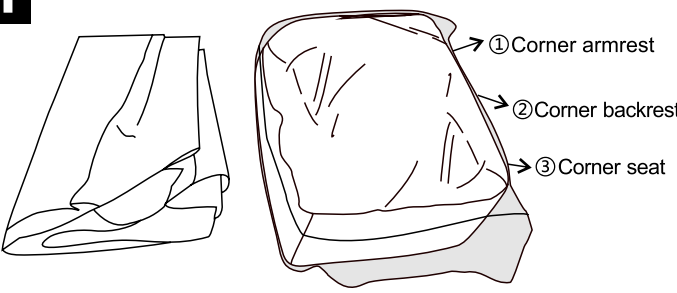
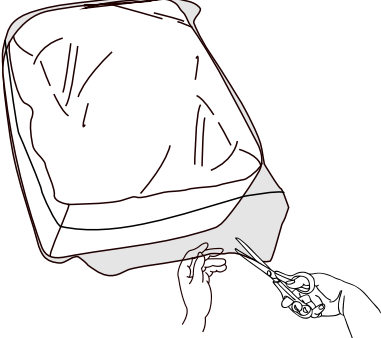

CORNER CHAIR ASSEMBLY INSTRUCTION

*** Read the instructions before installation.**

<p>1 Cover Inner Cushion=①+②+③</p>  <p>① Corner armrest ② Corner backrest ③ Corner seat</p> <p>Check what included in the Box. NOTES: Do not use sharp objects to open the outer carton box.</p>	<p>2 Inner Cushion</p>  <p>Unpacking the plastic bag.</p>
<p>3</p>  <p>Fully pat and shake the inner cushion for about 3 minutes ensure foam evenly filled in the nonwoven bag.</p>	<p>4</p>  <p>Check the sewing label attached on the nonwoven bag.</p>
<p>5 Step 1 Step 2</p> <p>Corner seat Seat</p>  <p>Fully zip up.</p> <p>1. Kindly put corner seat cushion in the cover. 2. Fully zip up the seat zipper.</p>	<p>6 Step 1 Step 2</p> <p>Corner backrest Corner armrest Fully zip up.</p>  <p>1. Kindly put corner backrest & armrest cushion in the cover. 2. Fully zip up the zipper.</p>
<p>7</p>  <p>Place the sofa in an upright position, leave the inner cushion to expand for 48 hours. Pat and organize the outer shape of corner chair.</p>	<p>8</p>  <p>Now you get a perfect corner chair.</p>

CONNECTOR BUCKLE

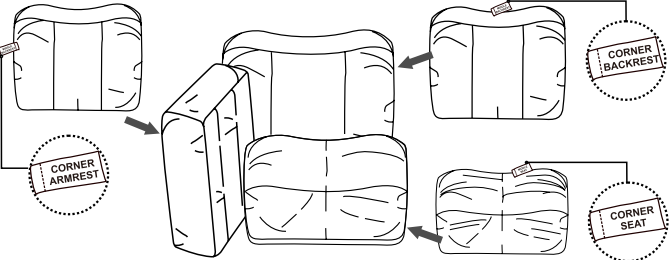
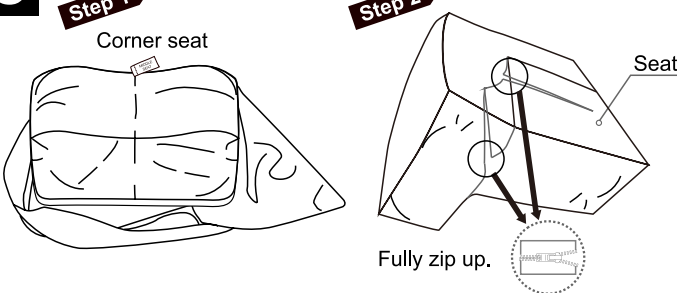
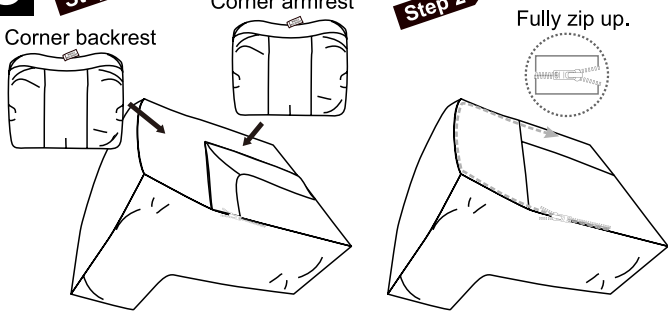
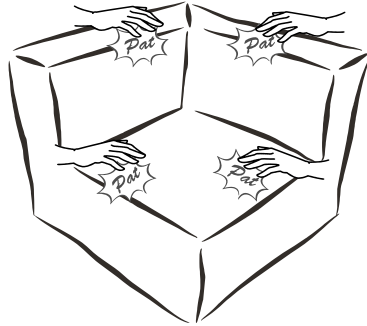
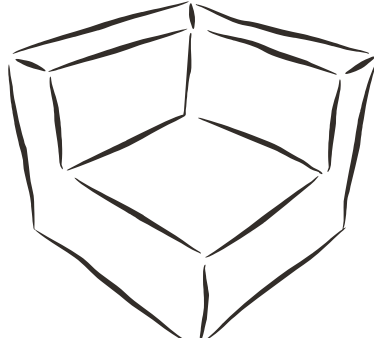
ASSEMBLY INSTRUCTION

* Read the instructions before installation.

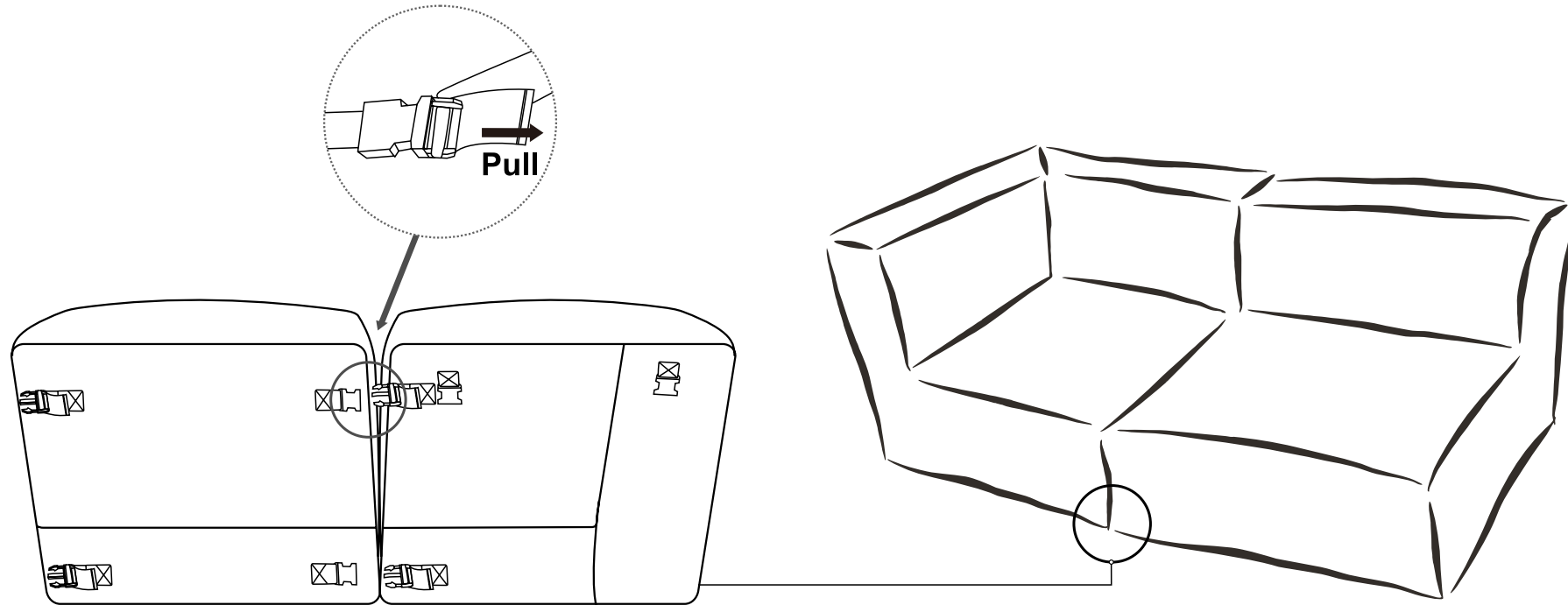

HOW TO CONNECT?

Connect the buckle located at the bottom of the chair,
and tighten the belt to a fit position to connect the two chairs.