

ASSEMBLE INSTRUCTION

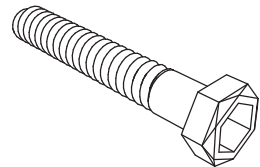

① Bolt x 8

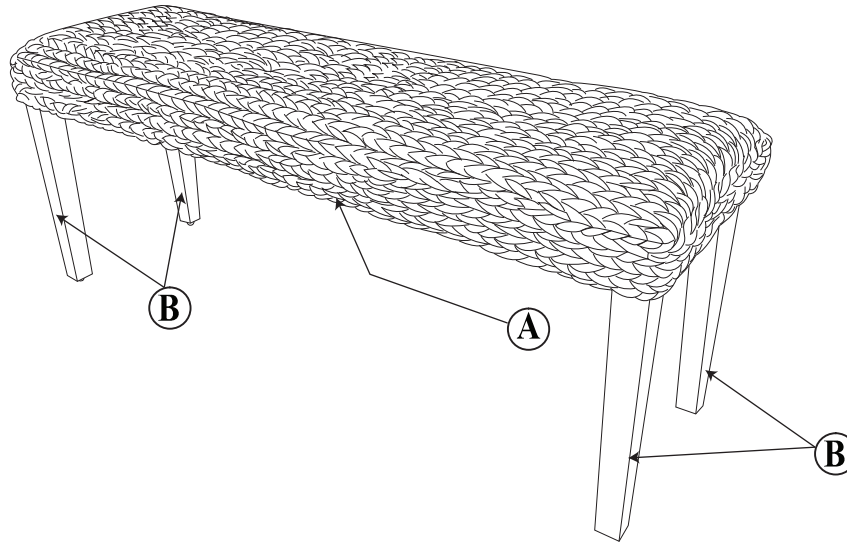
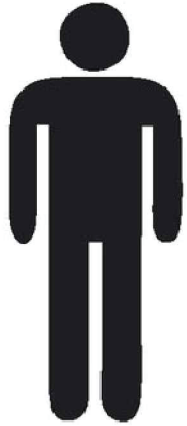
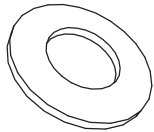

② Washer x 8

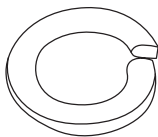

③ Spring Washer x 8

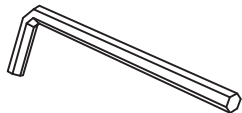

④ Hex Wrenches x 1

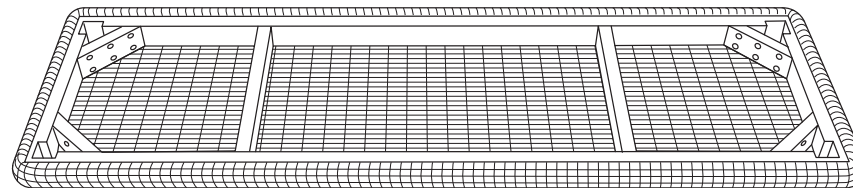

① A x1



② B x4

ASSEMBLE INSTRUCTION

Step 1 : Put the legs in to the bench.

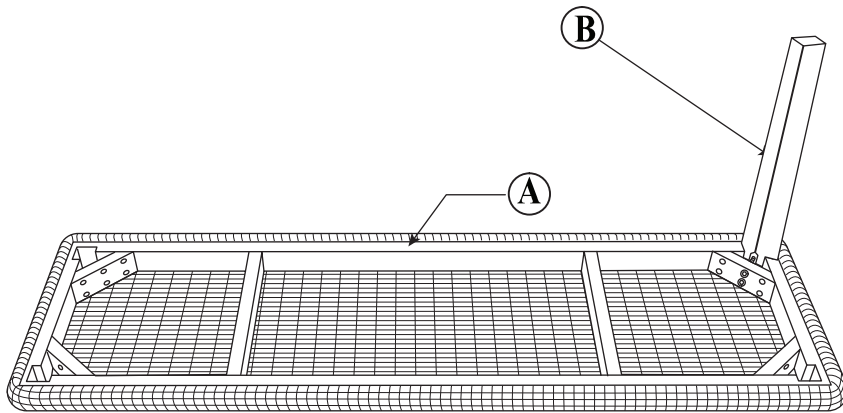

Step 2 : use hex wrenches to connect the legs with seat part by bolt and washer.

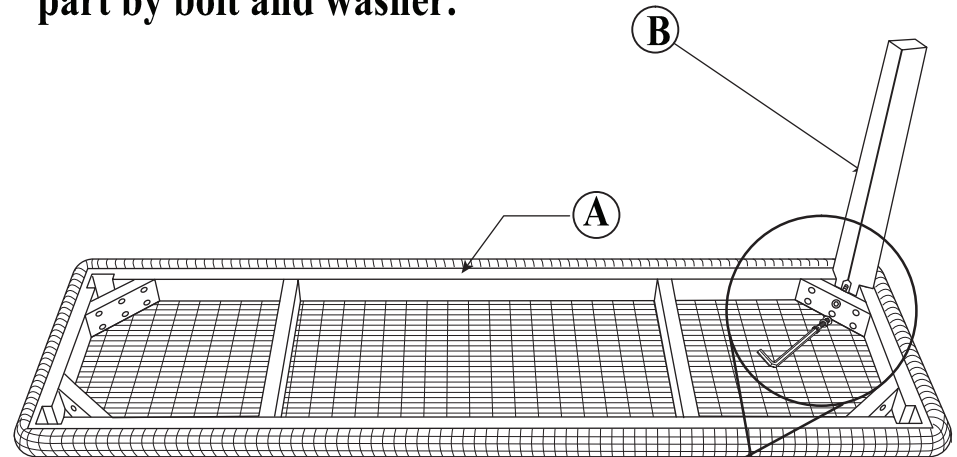

Step 3 : Repeat step 1 and step 2 for the other three legs.

