

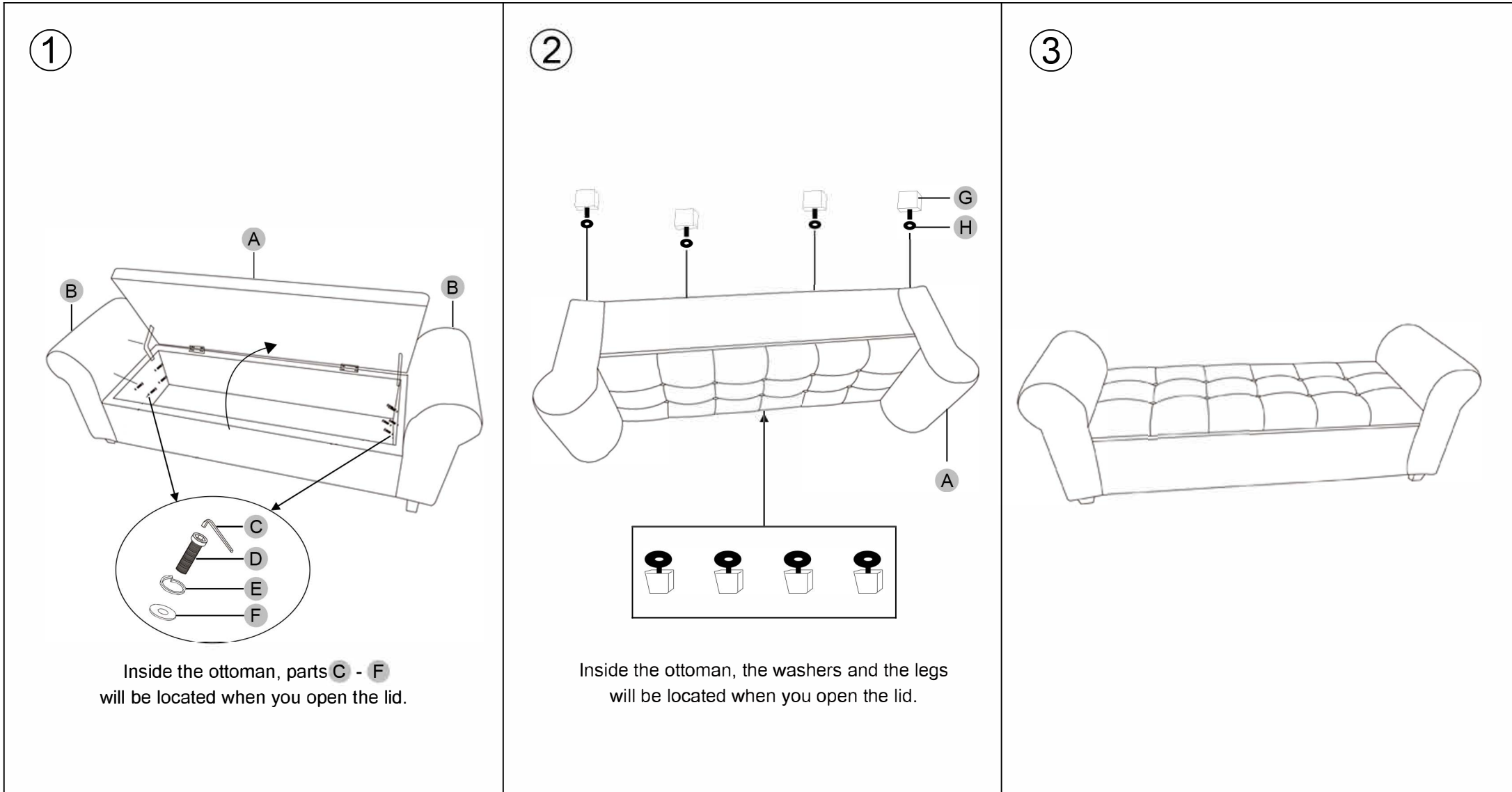







💡 Assembly Tips:

- **STEP 2** - Please rest assured that washers are optional and do not affect the safety of the chair.



<p>A</p>  <p>x1</p>	<p>B</p>  <p>x2</p>	<p>C</p>  <p>x1</p>	<p>D</p>  <p>8*55 mm</p> <p>B</p> <p>x8</p>	<p>E</p>  <p>φ8*10*1 mm</p> <p>x8</p>	<p>F</p>  <p>φ8*20*1 mm</p> <p>x8</p>	<p>G</p>  <p>65*65*60 mm</p> <p>x4</p>	<p>H</p>  <p>φ8*48*1 mm</p> <p>x4</p>
---	---	---	---	---	---	--	---