

FULL UPPER BUNK

ASSEMBLY INSTRUCTIONS



Before assembling your bed slat kit, please read through these instructions carefully and familiarize yourself with the different parts. Please note that you will require a Phillips screwdriver and an Allen wrench.



PARTS LIST

01	SLAT SECTION	2 SET
02	SUPPORT RAIL	2 PCS

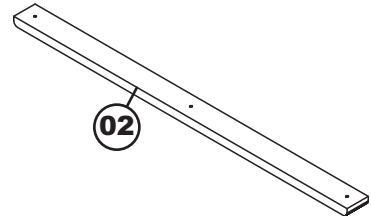
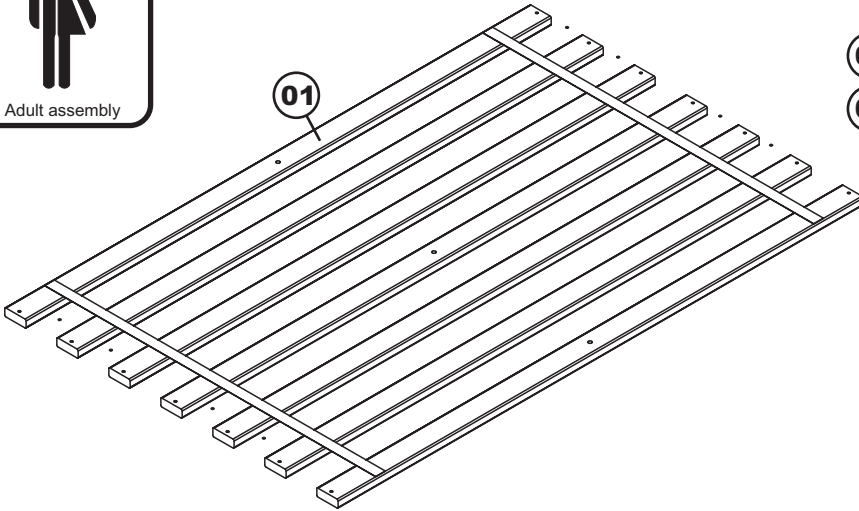

HARDWARE

NOTE: WE INCLUDE SPARE HARDWARE IN CASE THE ALLEN WRENCH, ALLEN SCREW, OR WOOD SCREWS ARE DAMAGED DURING ASSEMBLY.

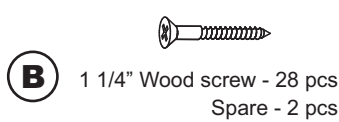
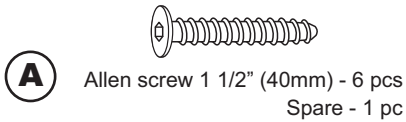

DETAIL ASSEMBLE VIEW

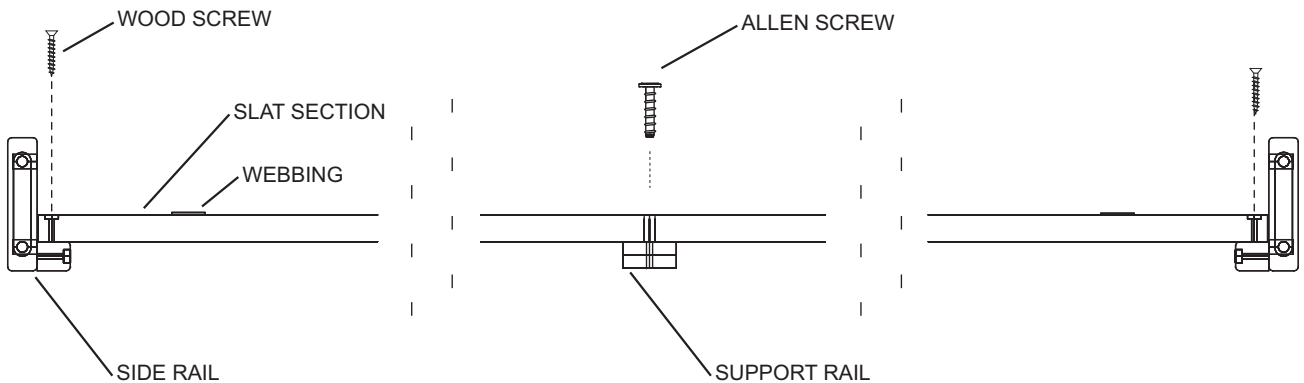

Step 1

Assemble bed frame according to assembly instructions.

FULL UPPER BUNK

Step 2

Lay the slat section onto the bed as shown. Attach support rail (02) to slat section (01) using Allen screw (A), tighten with the Allen wrench (C). Repeat for section 2

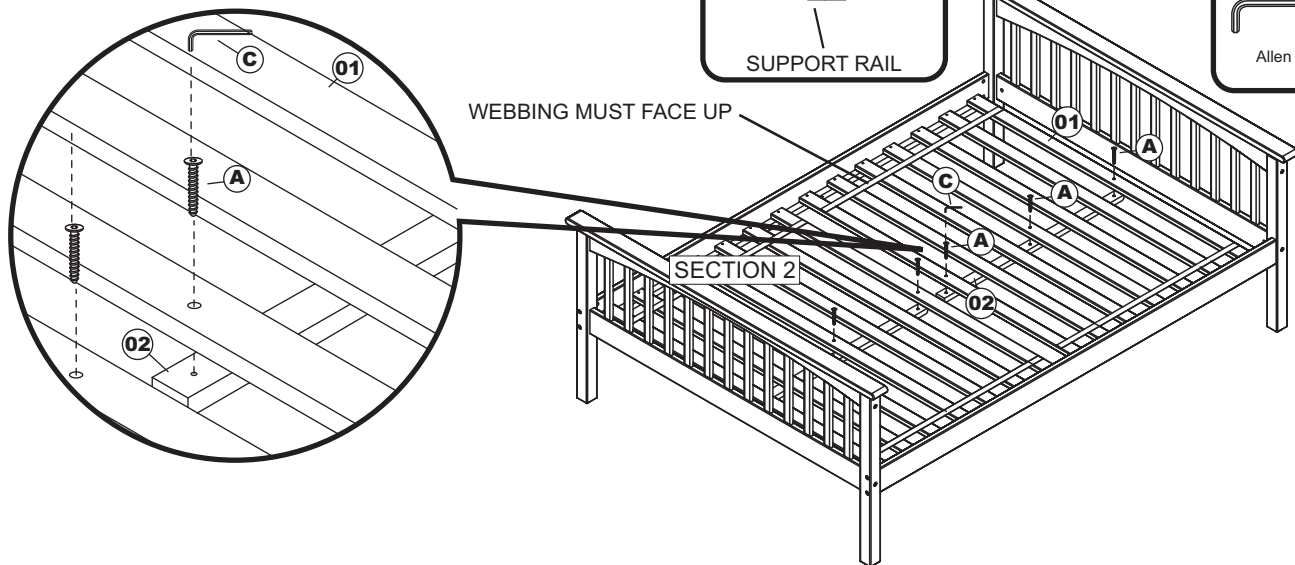
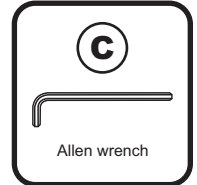
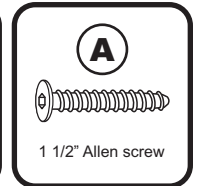

Step 3

Be sure to align slat section evenly with both ends of side rail.

Screw slat section (01) to side rail, using wood screw (B). Tighten with Phillips screwdriver. (Customer supplied)

Be sure the space between slats is even.

