

UALLY LLC
39-07 PRINCE ST,SUITE 4G
FLUSHING NY 11354
Email add: todefull@todefull.com

USER'S MANUAL

Baby Stroller
EKK0054DG/GR/PI

CATALOG

Component introduction

2

Installation introduction

3

Function introduction

6

Attention

11

PARTS INCLUDED

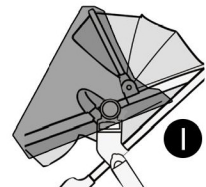
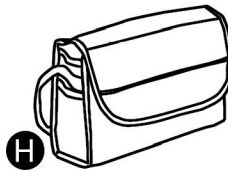
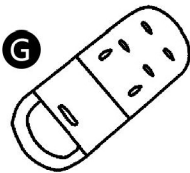
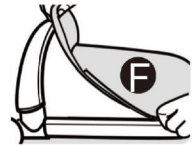
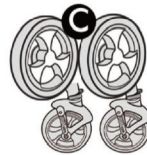
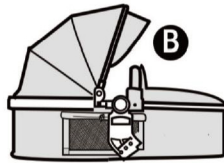
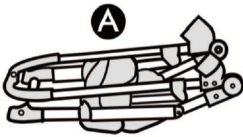

A.frame

D.cup holder

G.Cotton-padded mattress

B.basket

E.handrail

H.Mommy bag

C.wheels

F.footcover

I.Mosquito net

COMPONENT INTRODUCTION

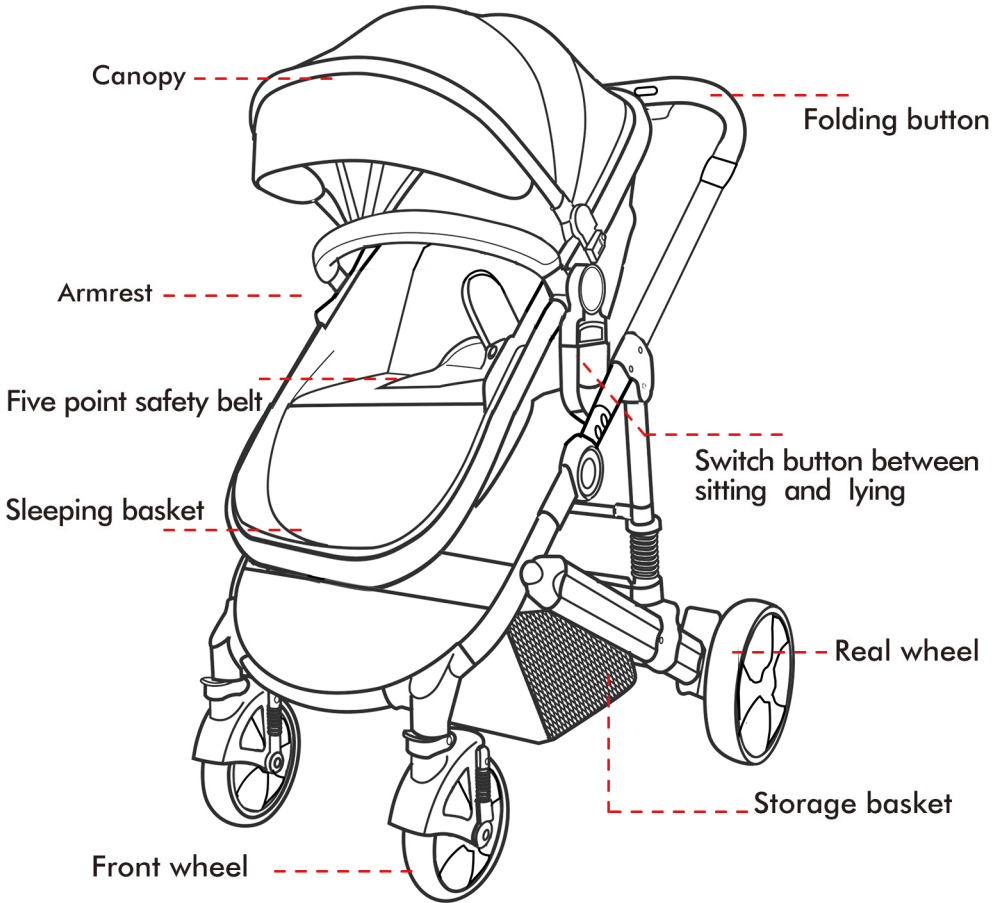

WARNING:

Keep all the plastic bags and small components away from the child to avoid possible suffocation and injury.

FUNCTION INTRODUCTION

1. Unfolding the frame.

Take out the frame, lift up the push bar to unfold the frame.

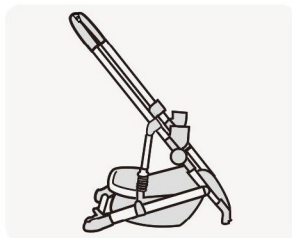
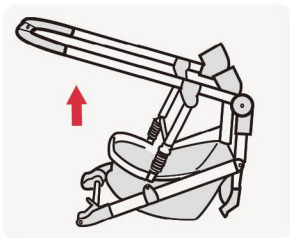
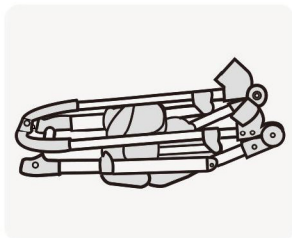

2. Front wheels assembly.

Lift the stroller frame front axle tube and insert front wheel axle. Push up until you hear an audible "click" to indicate the front wheel is locked into position. Repeat for the second wheel.



3. Rear wheels assembly.

Lift the stroller frame rear axle tube and insert rear wheel axle until you hear an audible "click" to indicate the wheel is locked into position. Repeat for the second wheels.

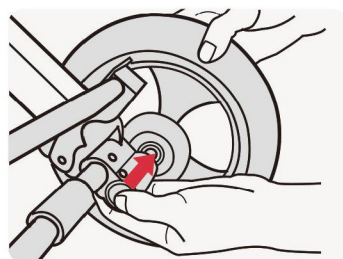
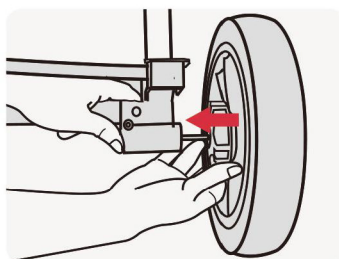

INSTALLATION INTRODUCTION

4. Seat and armrest installation.

Lift up the slot on both sides of the basket, insert into the frame posts until you hear an audible "click" sound. Insert the armrest into the slot above the white button.

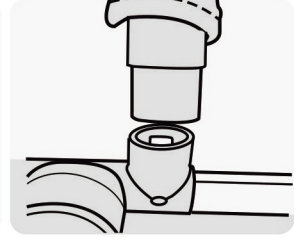
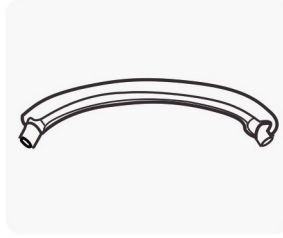
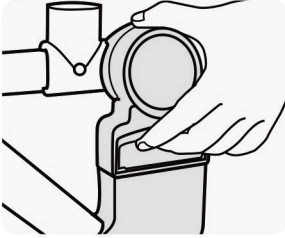

WARNING:

Do not use the sleeping basket as a basket. Do not lift the basket with an armrest. To avoid injury, do not move or adjust the seat when the baby is seated.

5. Canopy installation.

Slightly insert the canopy to the sleeping basket socket to finish the first step. After that, pull up the canopy zipper.

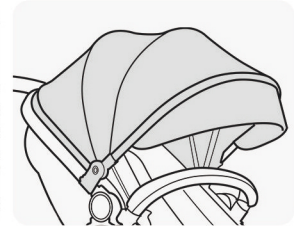
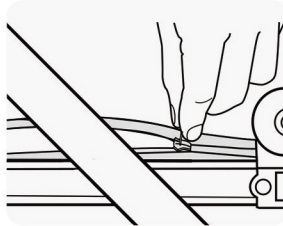
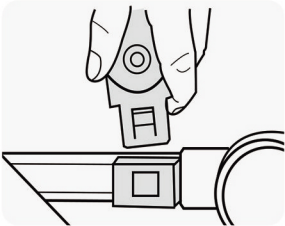

INSTALLATION INTRODUCTION

6. Install the footcover.

Pull up the foot cover and the zipper of the sleeping basket, and buckle the snap button that is connected to the armrest.

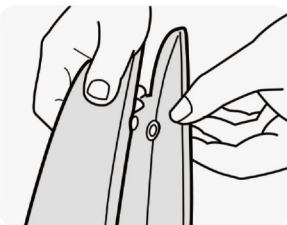
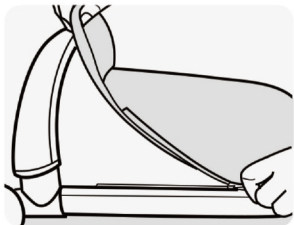

7. Install the cup holder.

Place the cup holder on the frame side as shown. The maximum load of the cup holder is 0.5kg.

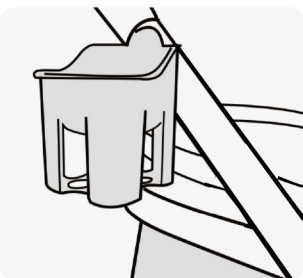

8. Install the armrest.

Hold the red arrow with your finger, pull up the armrest, and do the same on the other side.

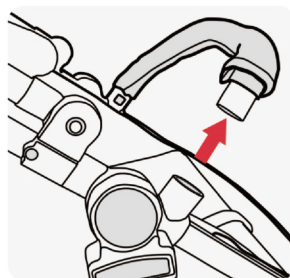
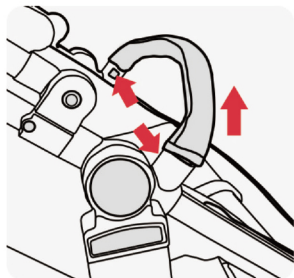

FUNCTION INTRODUCTION

1. Pram body adjustment button.

The thumb holds down the small button on the top, and the rest of the fingers adjust upward. Then sleep basket can be adjusted to switch between sleeping, lying or sitting position.

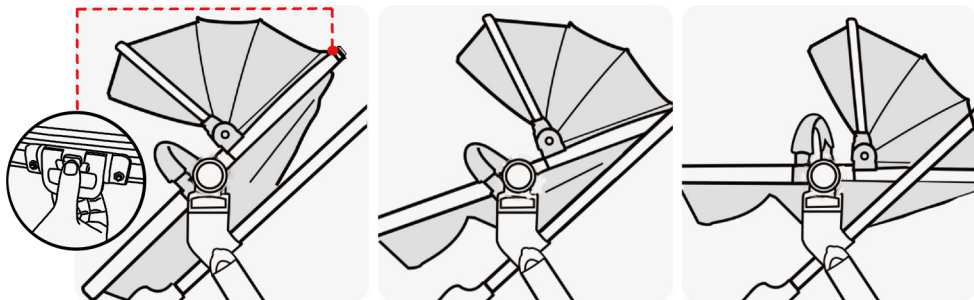

2. Reversible seat unit.

Lift up the slot on both sides of the basket, insert into the frame posts until you hear an audible "click" sound.

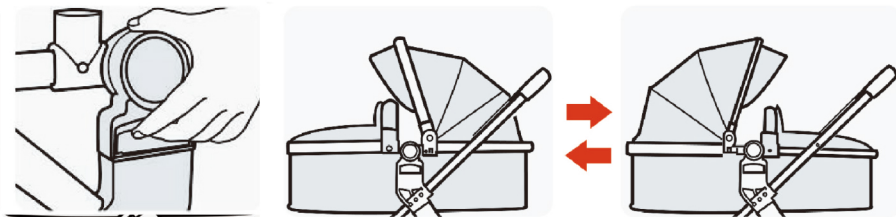

3. Change the sleeping basket to sitting status.

Tighten the steeples adjustment belt, adjust the backrest angle, it will be changed to the sitting position.

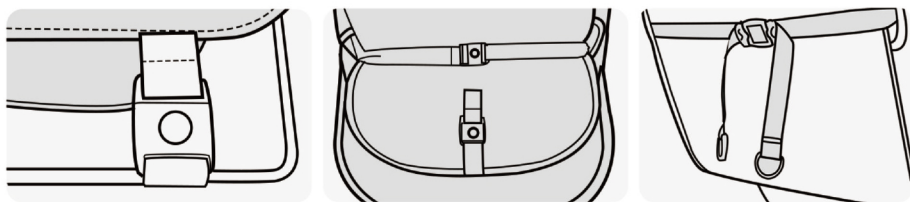

Sleeping basket reinforcement support rod: First, fix the seat bottom fixing belt on the reinforcement support rod, and then buckle upon the button to prevent the inertia of the button of the button of the seat from suddenly turning out when the speed of the stroller is relatively fast.

4. Canopy adjustment.

The canopy can be adjusted to multiple positions depending on the weather and the baby's condition.

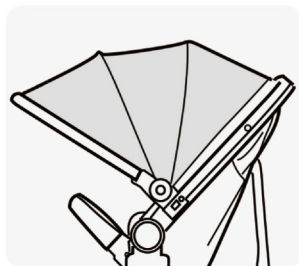
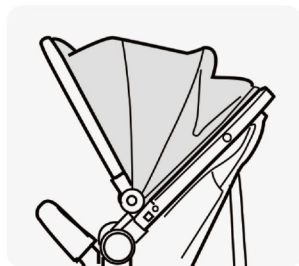
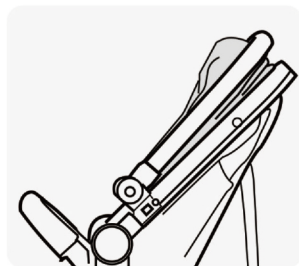

5. Five point safety belt.

1. Insert the arm safety belt into the waist belt buckle.
2. Then lock it into the main buckle with the red button.
3. Press the red button to unlock the safety belt.

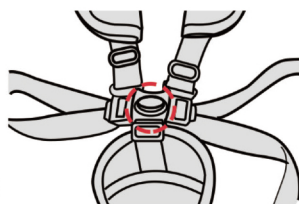
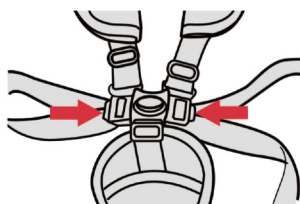

FUNCTION INTRODUCTION

6. Safety belt adjustment.

1. The length of the safety belt can be adjusted by sliding the safety belt buckle to achieve the required tightness.

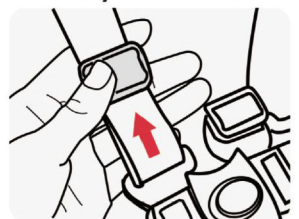

Tighten upward



Loosen downward

WARNING:

In order to avoid injury, when the baby sitting on the seat, do not move or adjust the pram body. Avoid serious injury from falling or sliding out. Always use seat belt.

7. Sleeping basket ventilation window.

Three mesh ventilation windows, in summer, sleeping basket ventilation, in winter, sleeping basket windproof and warm.

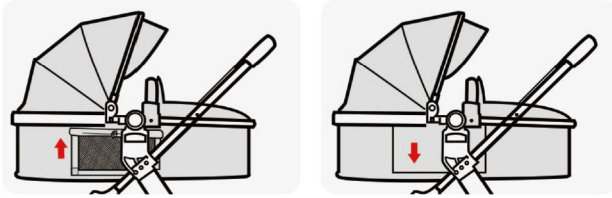

8. Front wheels direction universal and fixing.

To fix the direction of the front wheels, align front wheels in a straight forward position and press down the front wheel lock, the front wheels can only move straight forward and backward. Lift up the front wheel direction lock, direction of the front wheels can be universal.

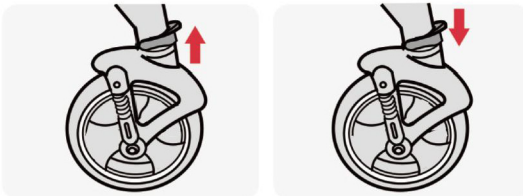

Universal rotating

Fixing direction

FUNCTION INTRODUCTION

9. Rear wheels one touch brake.

1. lift up the rear wheel axle to release the brake, then the stroller can move freely.
2. The locking status, the stroller unable to move.

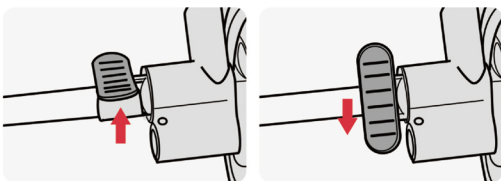

WARNING:

- This product is suitable for a child who cannot sit up by itself, roll over and cannot push itself up on its hands and knees.
- Do not let children stand on the seat.
- Never carry more than one child per seat.
- Please do not use in rough places, stairs and other dangerous places.
- Keep the plastic cover away from the baby to avoid suffocation.
- Keep away from fire.
- Accessories which are not approved by the manufacturer shall not be used.
- Do not lift by the armbar.
- Child may slip into leg openings and strangle. Never use in reclined carriage position(s) unless the safety belt are used.
- Excessive weight may cause a hazardous unstable condition to exist.

10. One key to fold stroller.

Simultaneously press and hold the round button above the push handle and the protruding button below, and press down on the frame until the cart is fully folded. The thumb presses the small button at the top, the rest of the fingers adjust upward, and the other hand moves the bottom part of the basket upward, so that the basket folds together.

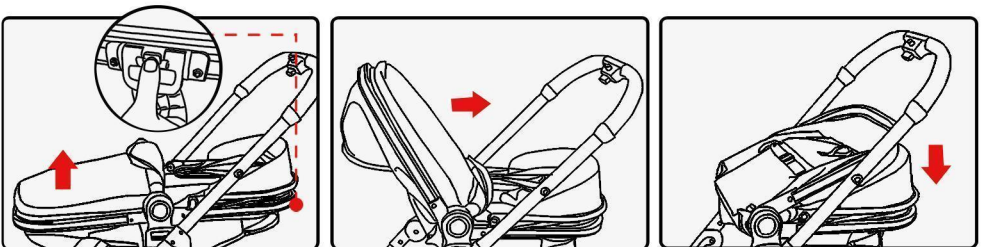

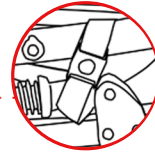
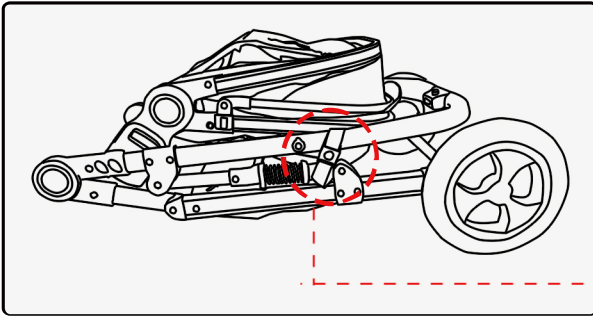
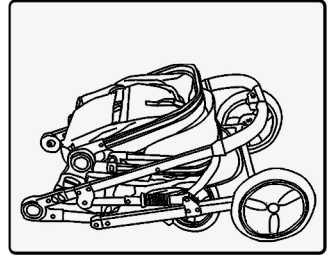
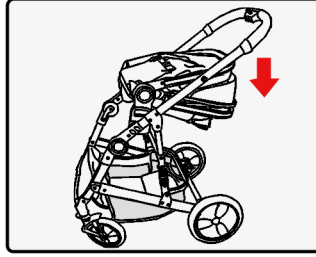
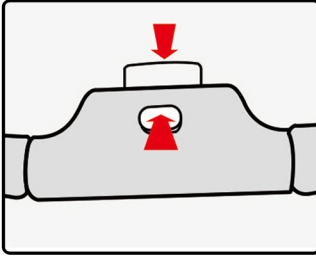

**Lock the
folding hook**

WARNING:

To avoid injury ensure that the child is kept away when unfolding and folding this product.

Do not place heavy objects at the top of the stroller.

Do not use other non-original parts or accessories.

For dust and general stains, it is recommended to use a wet cloth to scrub quickly and dry quickly. The seat cloth and the sunshade canopy are not machine washable.

In order to avoid damage to the fabric surface, Do not brush the fabric with force.

Put the fabrics in a ventilated place to dry after washing, do not expose.

WARNING:

- Never leave the child unattended.
- Ensure that all the locking devices are engaged before use.
- Do not let the child play with this product.
- Use a harness as soon as the child can sit unaided.
- For new born baby, recommend the use of most reclined position is sleeping position.
- This seat unit is not suitable for children under 6 months. Information concerning the maximum weight of the child for which the vehicle is suitable up to: 22 kg(= 50 lbs); the maximum load of 3kg(=6.6lbs) for the storage basket. The maximum load cup holder is 0.5kg(= 1.1 lbs).
- Always use the restraint system.
- Check that the pram body or seat unit or car seat attachment devices are correctly engaged before use.
- This product is not suitable for running or skating.
- Make sure that the parking device shall be engaged when placing and removing the children.
- Any load attached to the handle and/or on the back of the backrest and/or on the sides of the vehicle will affect the stability of the vehicle.
- No additional mattress shall be added.
- Only replacement parts supplied or recommended by the manufacturer/distributor shall be used.