

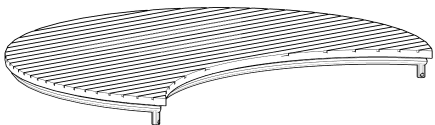

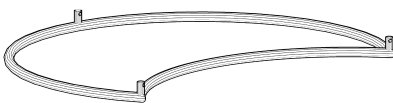



ASSEMBLY INSTRUCTIONS

<p>AX1</p> 	<p>BX1</p> 	<p>CX5</p> 	
<p>DX2</p> 	<p>EX2</p> 		
<p>HX10</p> 	<p>IX10</p> 	<p>JX1</p> 	<p>Extra Hardware</p> <p>HX2</p> <p>IX2</p>

- Note:
1. Please do not tight any bolt unless all bolts are fixed at their respective places.
 2. After fixing the bolts tighten them simultaneously.
 3. Matching Parts Bolt (example AtoA)
 4. Two person assembly required.

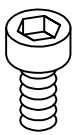

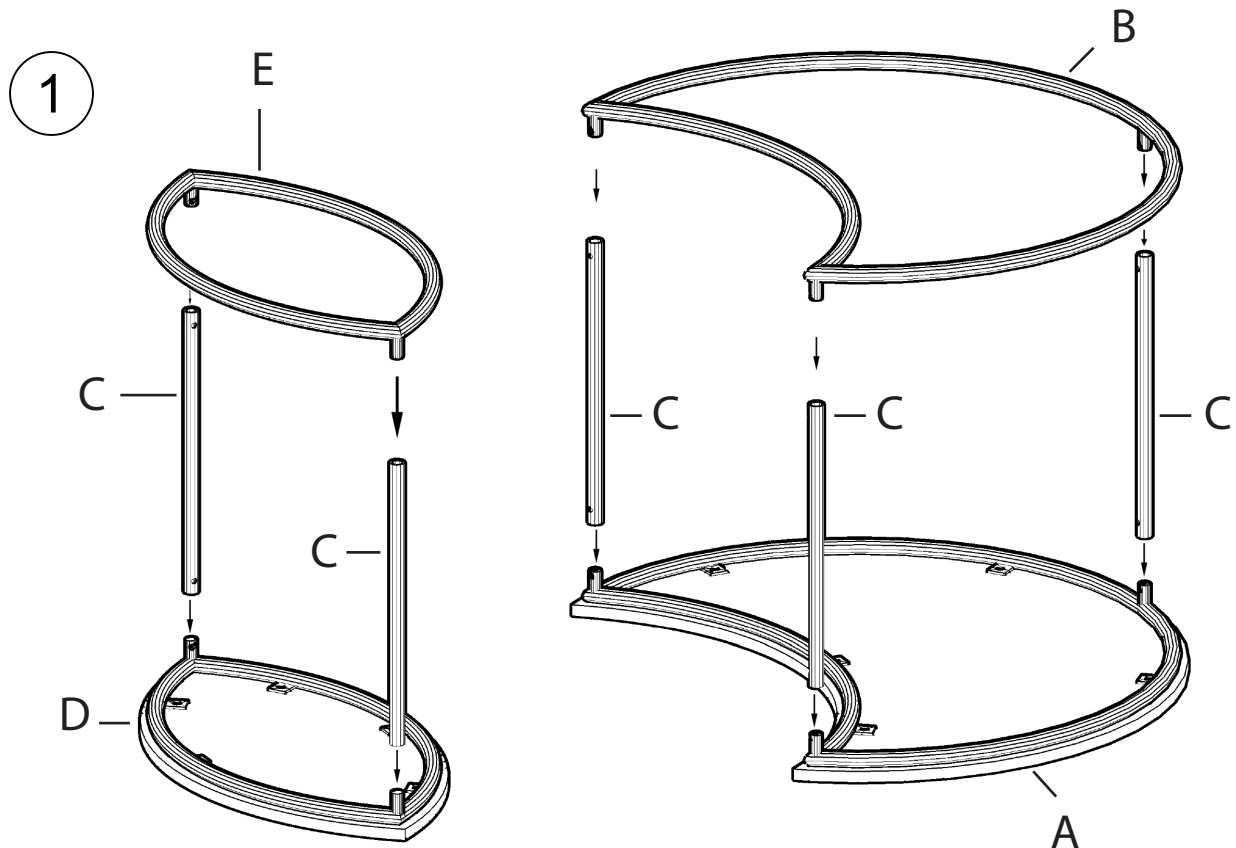
ASSEMBLY INSTRUCTIONS

2

