

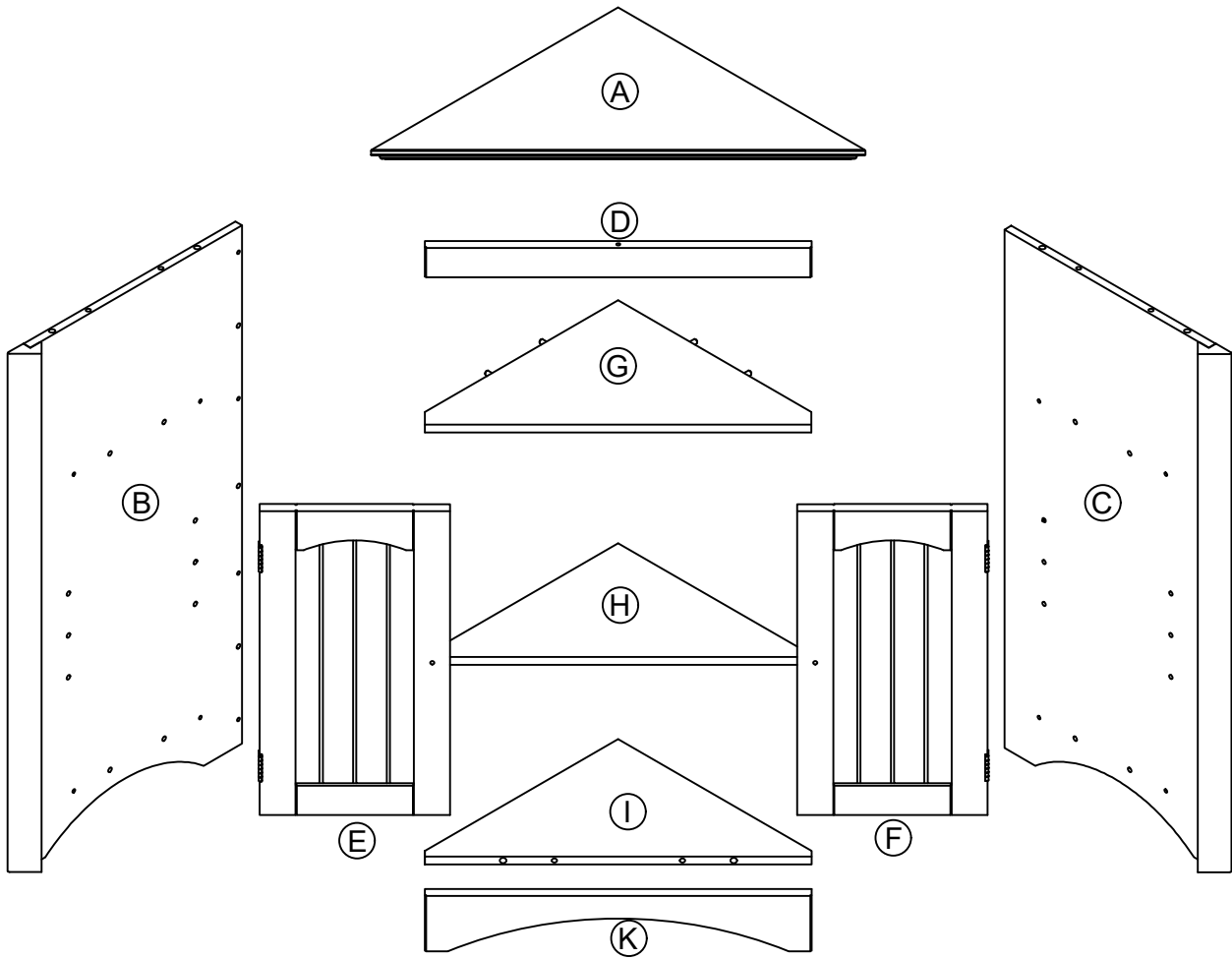

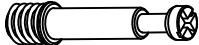







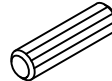

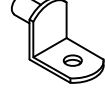
PACKAGE CONTENTS

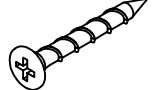

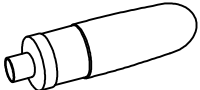
PART	DESCRIPTION	QTY		PART	DESCRIPTION	QTY
A	Top Panel	X1		F	Right Door	X1
B	Left Side Board	X1		G	Upper Shelf	X1
C	Right Side Board	X1		H	Shelf	X1
D	Front Bar	X1		I	Base Panel	X1
E	Left Door	X1		K	Base Panel Front Rail	X1

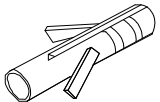
HARDWARE CONTENTS

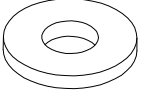

1	2	3	4
 Ø6*33mm 18PCS	 Ø15*9mm 18PCS	 Ø6*30mm 21PCS	 2PCS
5	6	7	8
 5/32"*19mm 2PCS	 4PCS	 Ø3*10mm 4PCS	 Ø4*38mm 4PCS
9	10	11	□2
 Ø3*12mm 8PCS	 1PC	 Ø4*20mm 1PC	 □□□
13	□4		
 □□□	 2□□S		

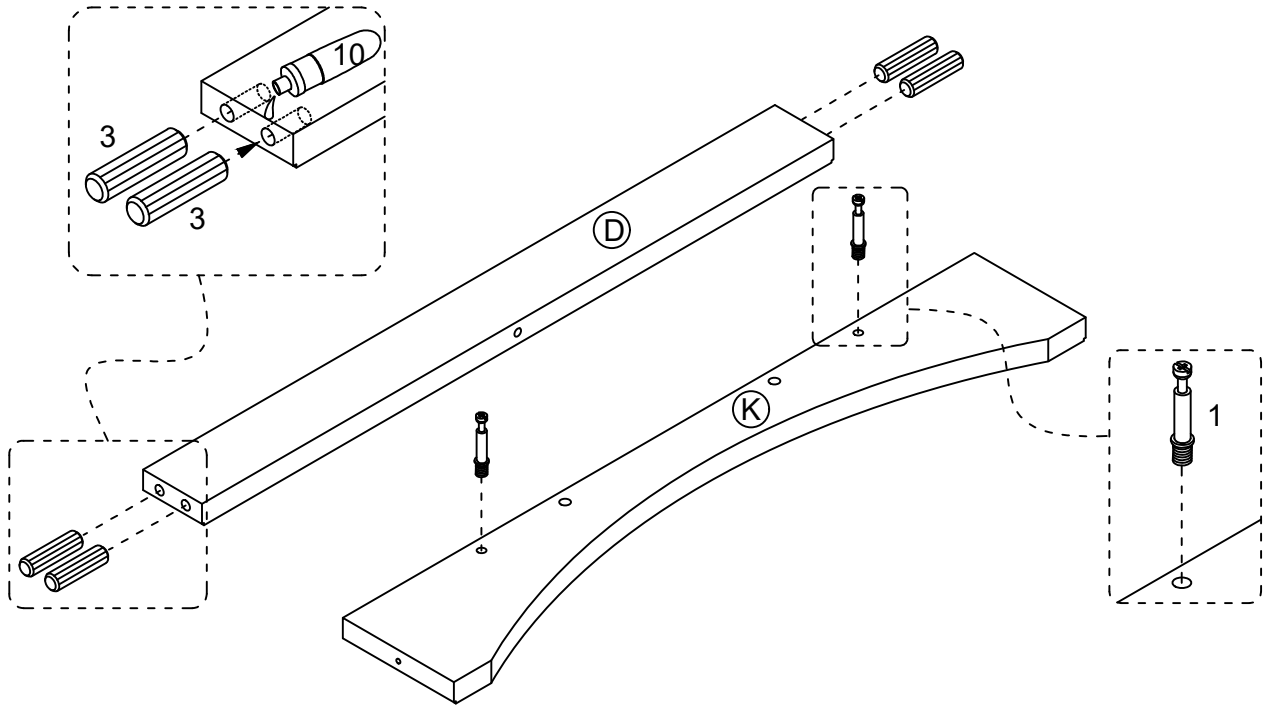
STEP1

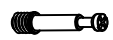

Glue the wood dowels 3 into the inner holes on the side panels D.

NOTE: It is very important to use a small amount of glue 10 on ends of dowels and wipe away excess glue immediately.

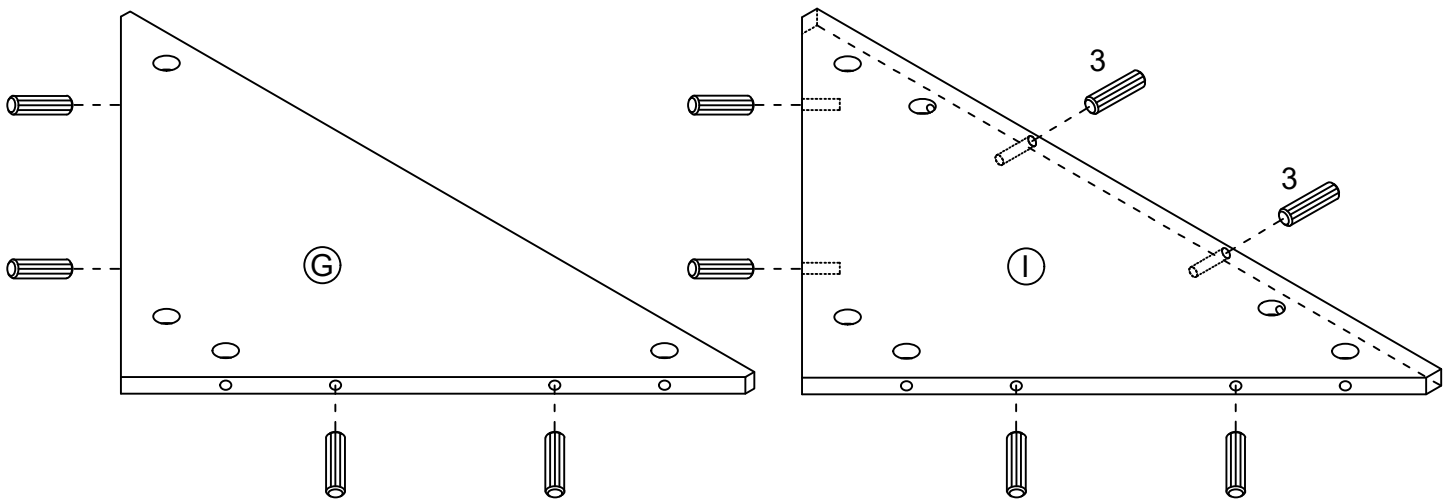
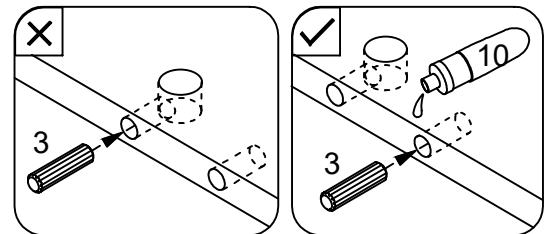

	1 x 2pcs
	3 x 4pcs
	10 x 1pc

STEP2





Glue the wood dowels 3 into the inner holes on the front upper rail G and I .

NOTE: It is very important to use a small amount of glue 10 on ends of dowels and wipe away excess glue immediately.

	3 x 10pcs
	10 x 1pc

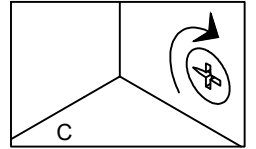
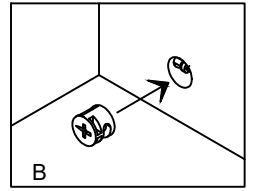
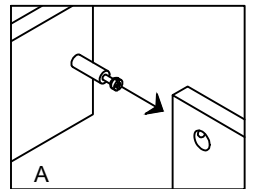
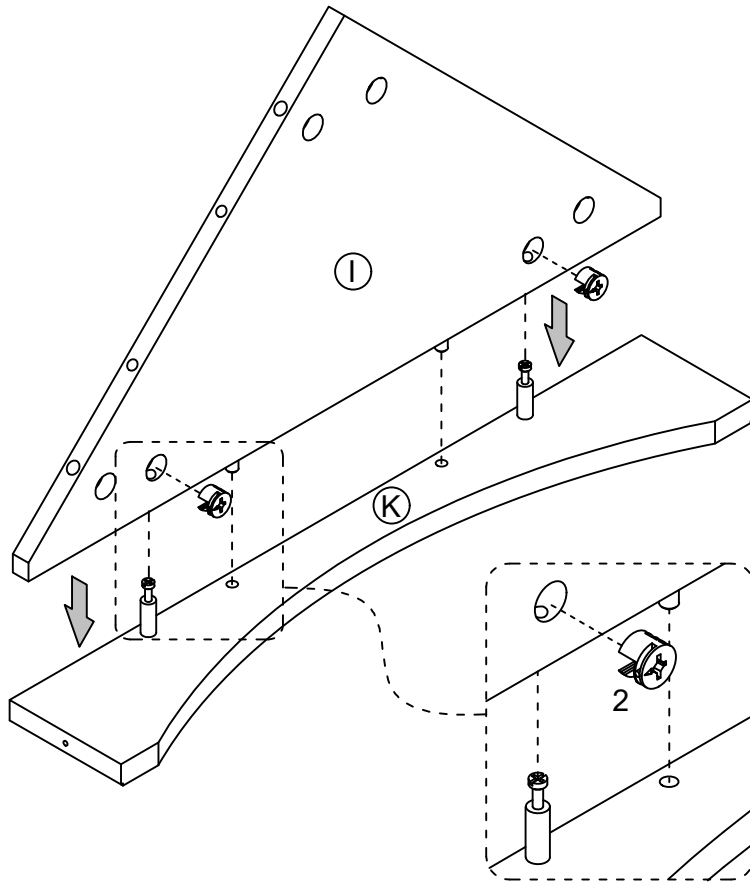
STEP3



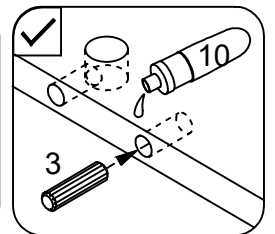
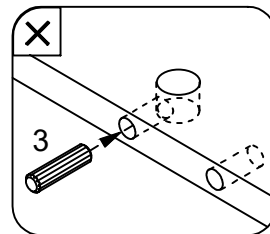
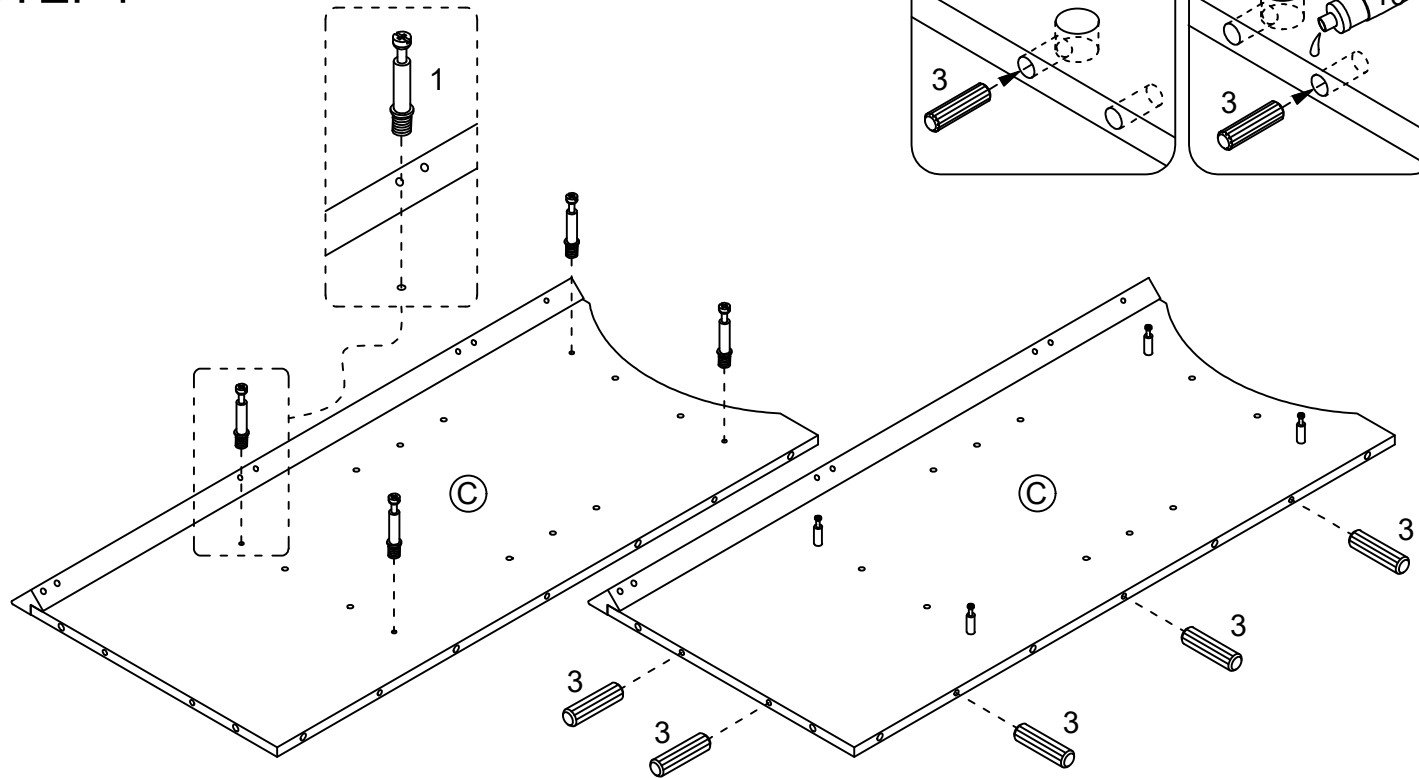

	2 x 2pcs
---	----------

STEP4

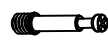

Glue the wood dowels 3 into the inner holes on the side panels C.
 NOTE: It is very important to use a small amount of glue 10 on ends of dowels and wipe away excess glue immediately.

	1 x 4pcs
	3 x 5pcs
	10 x 1pc

STEP5

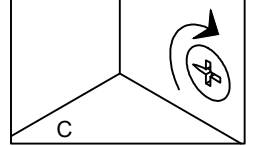
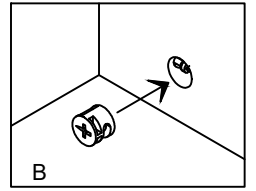
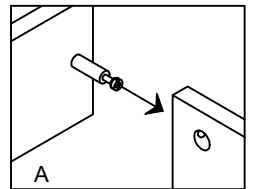
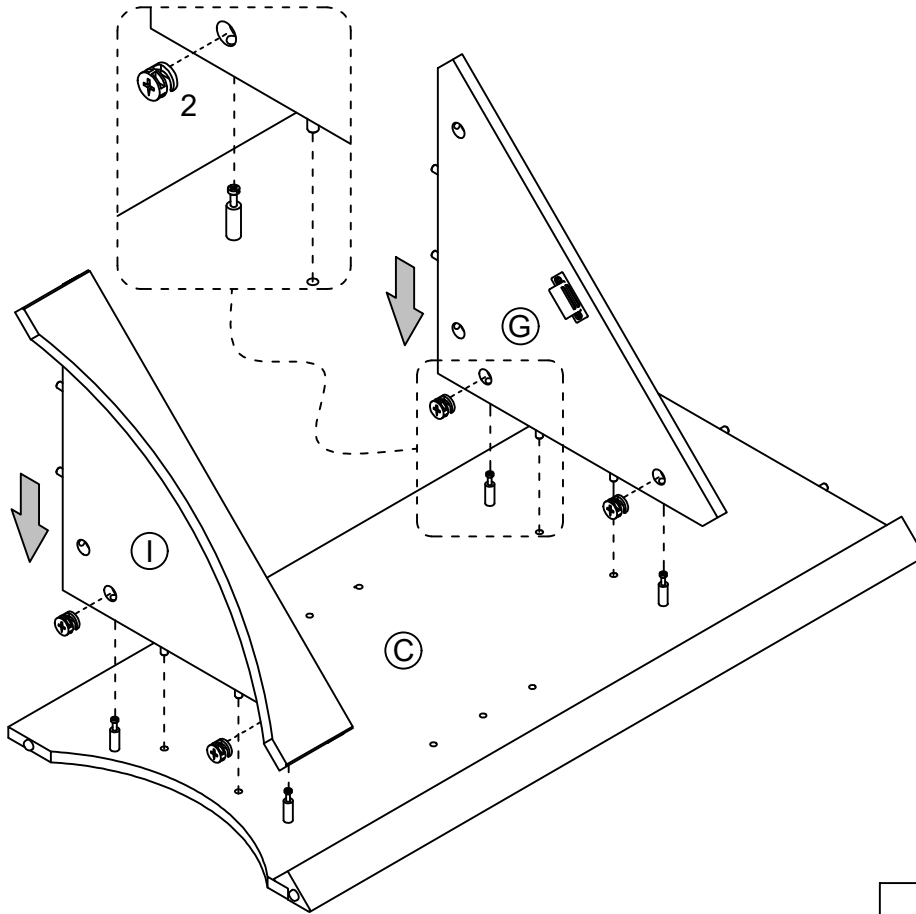

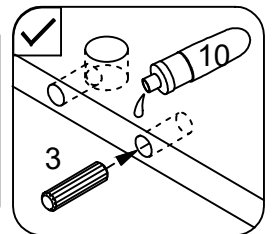
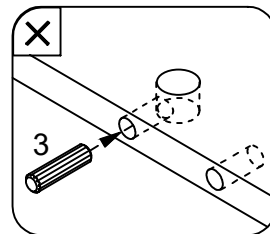
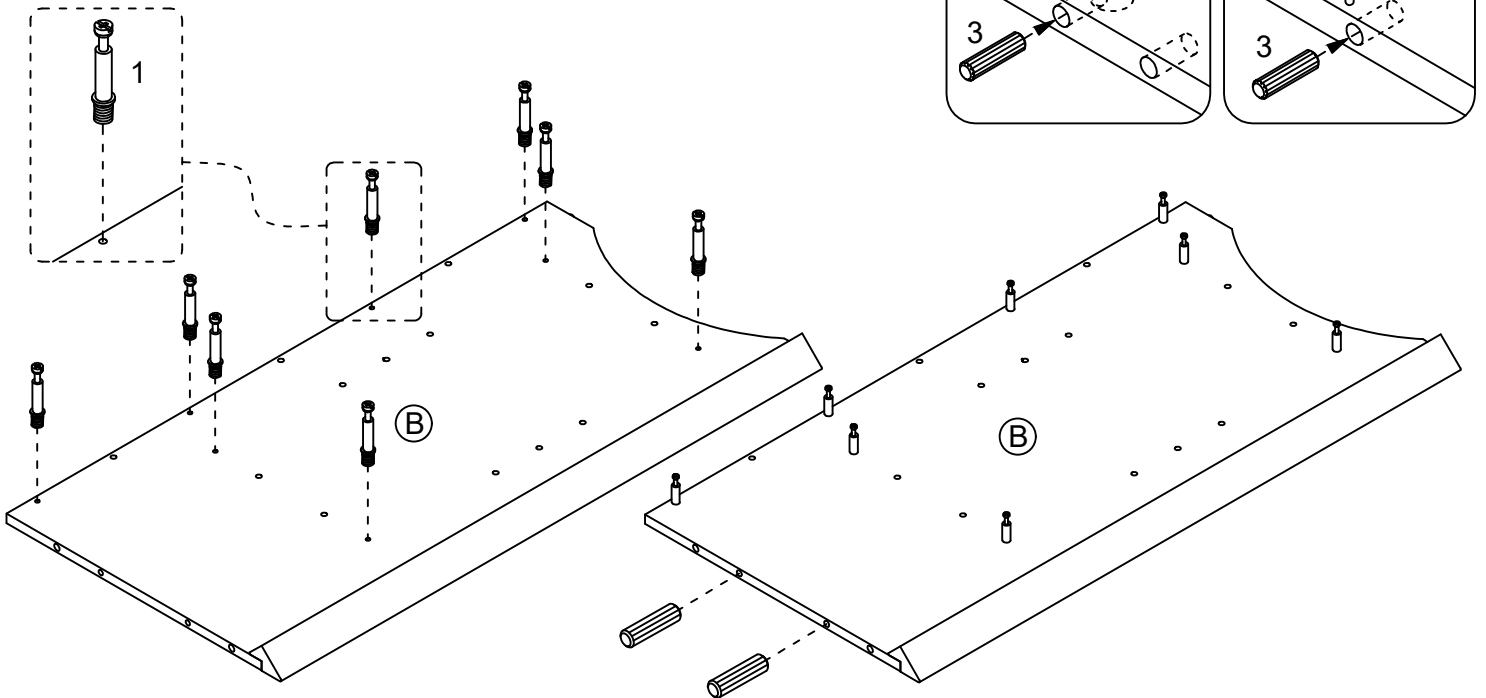

	2 x 4pcs
---	----------

STEP6





Glue the wood dowels 3 into the inner holes on the side panels B.

NOTE: It is very important to use a small amount of glue 10 on ends of dowels and wipe away excess glue immediately.

	1 x 8pcs
	3 x 2pcs
	10 x 1pc

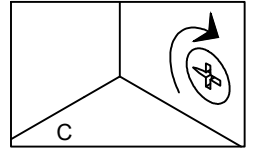
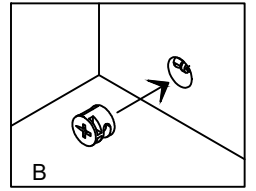
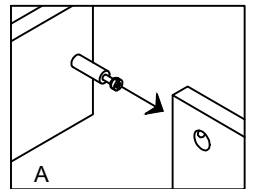
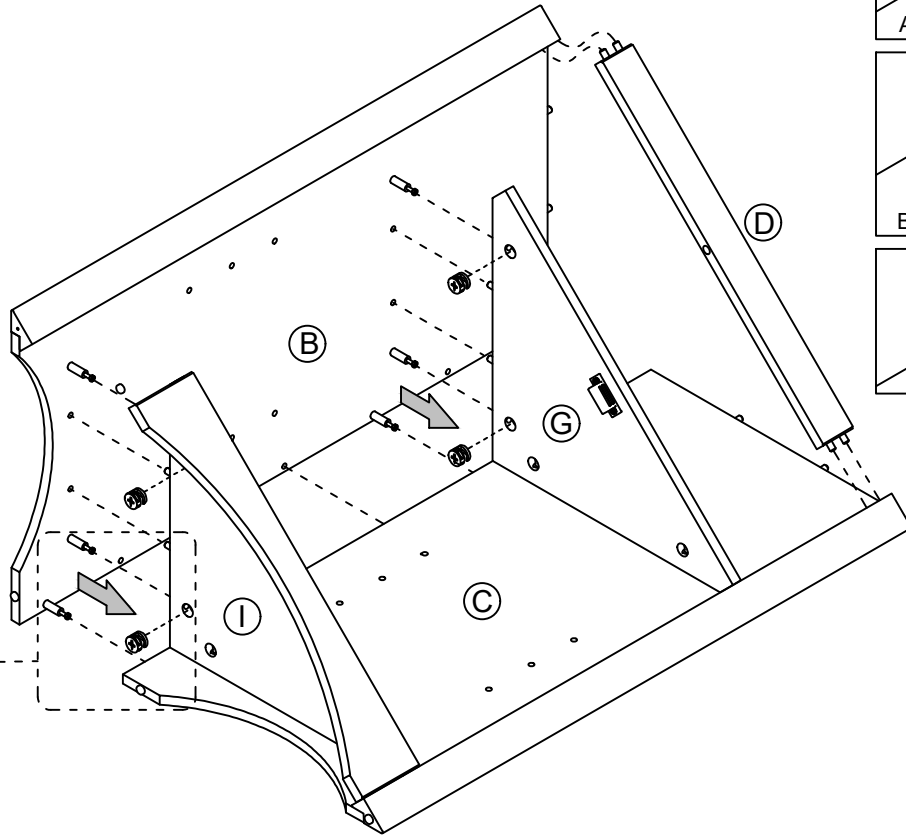
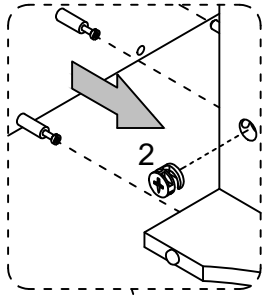

STEP 7

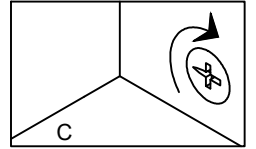
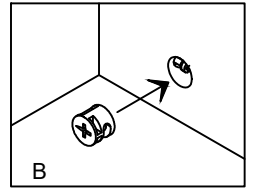
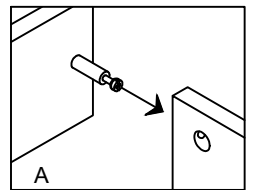
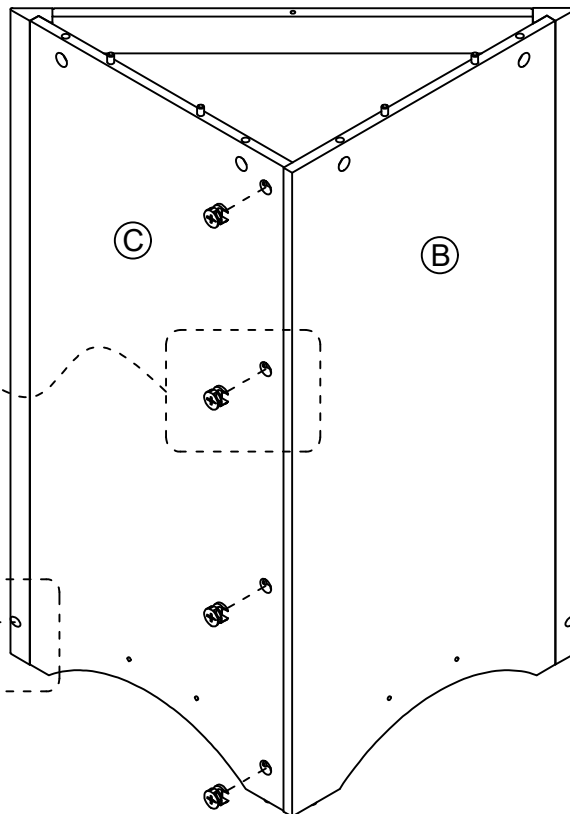
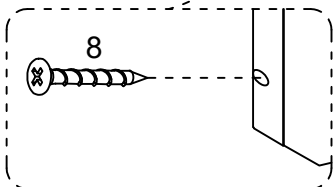
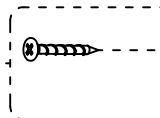
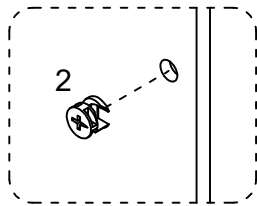

	2 x 4 pcs
---	-----------

STEP 8



	2 x 4 pcs
	8 x 2 pcs

STEP9

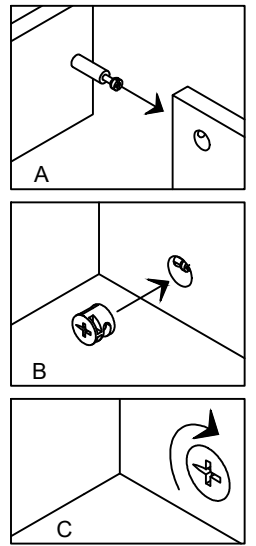
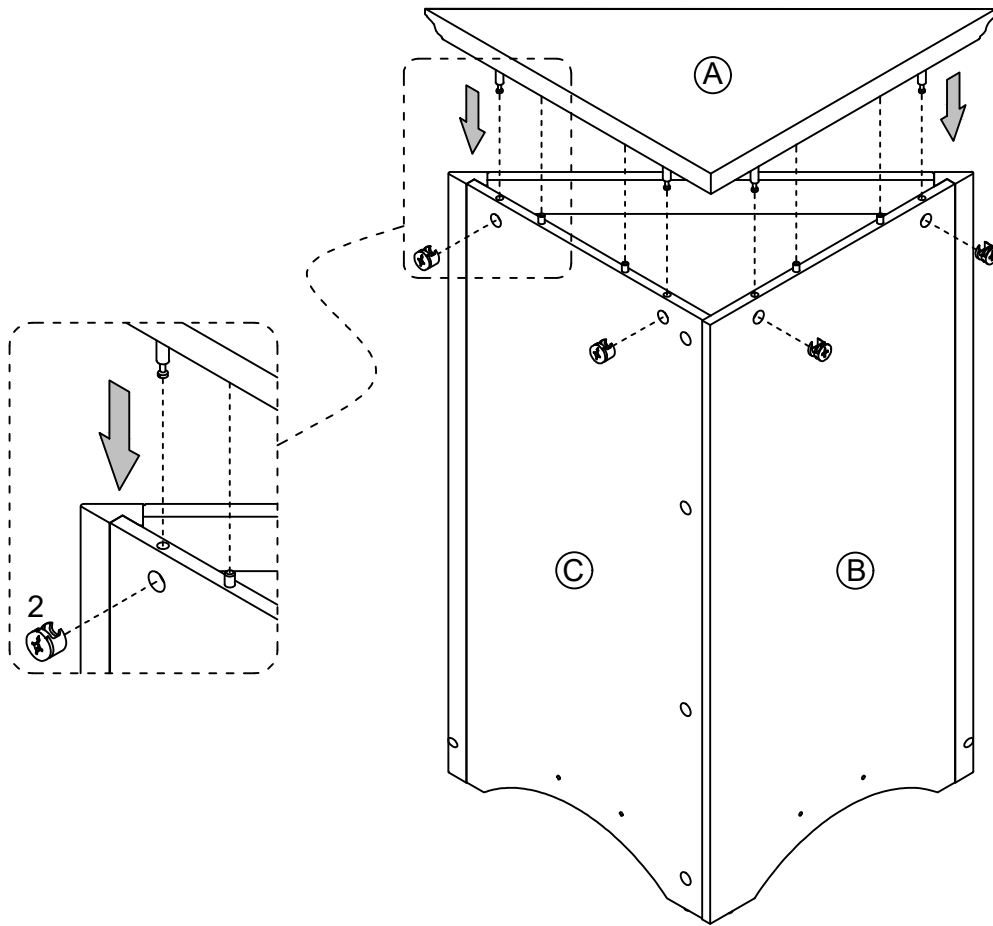

 2 x 4pcs

STEP10

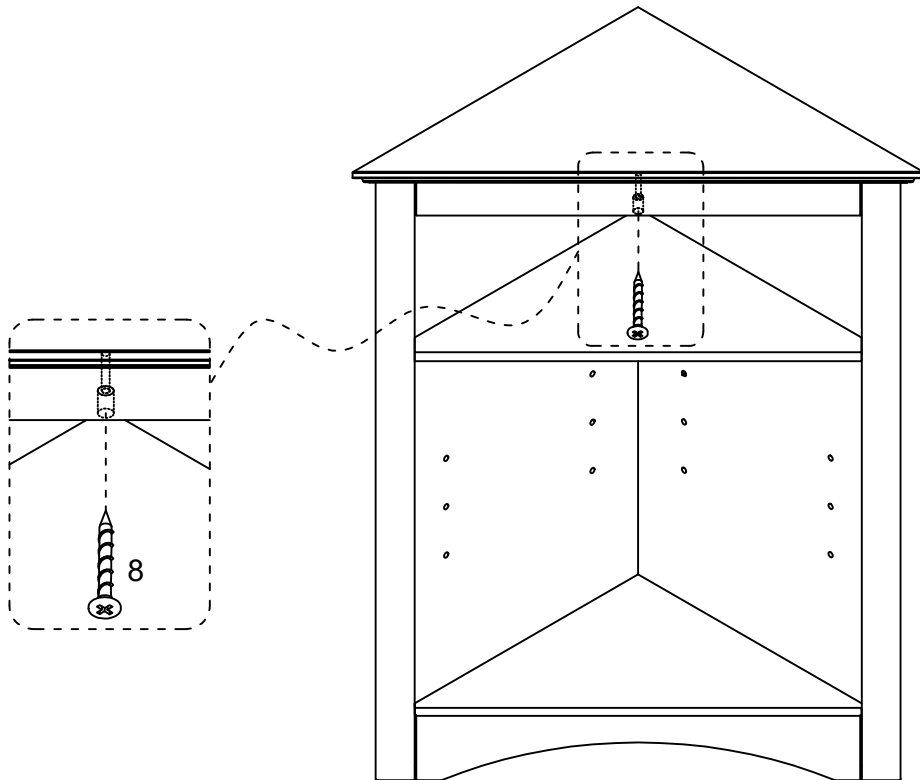

 8 x 1pc

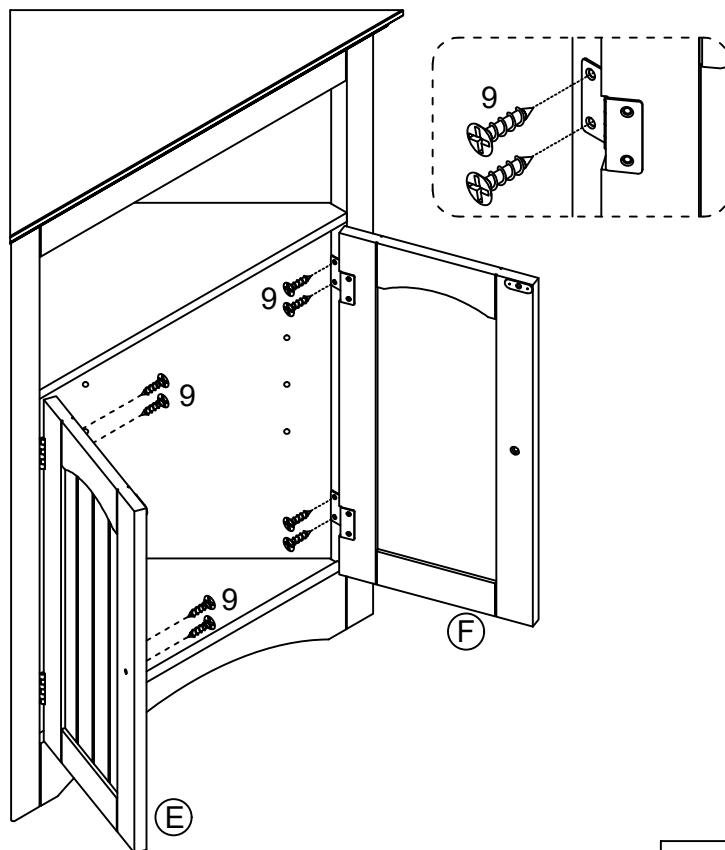

STEP11



	9 x 8pcs
---	----------

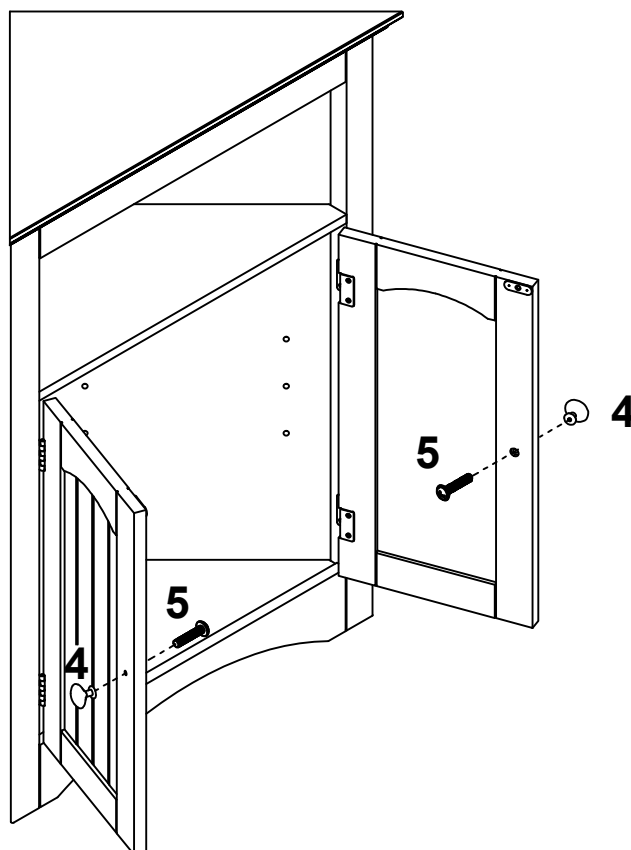

STEP12



	4 x 2pcs
	5 x 2pcs

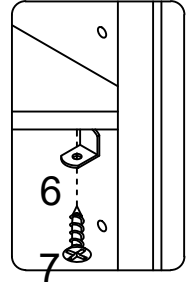
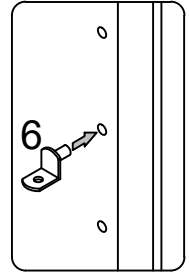
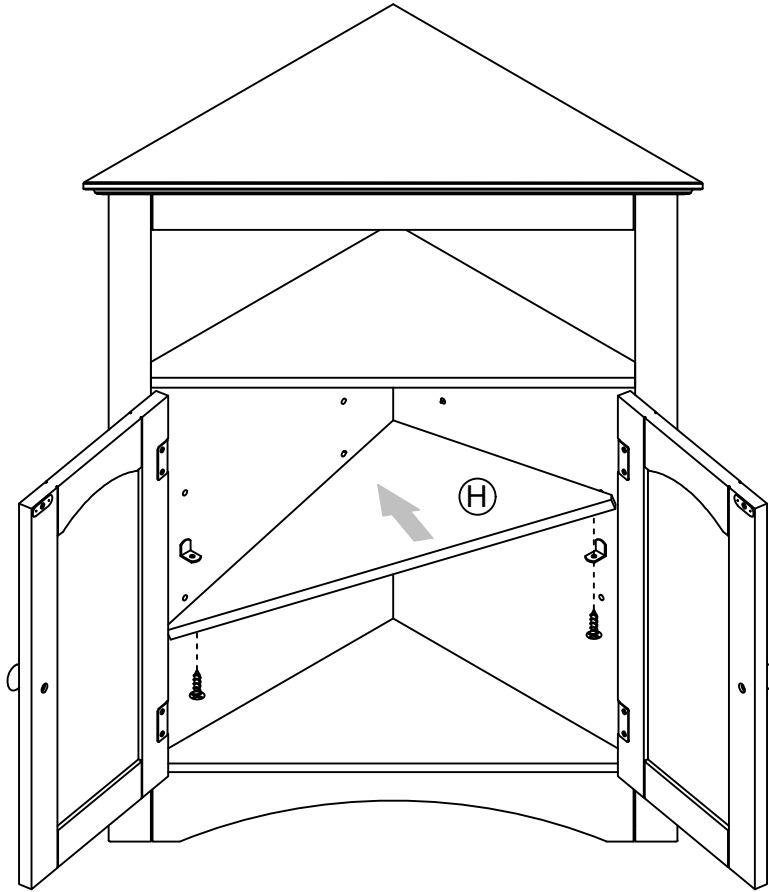



STEP13

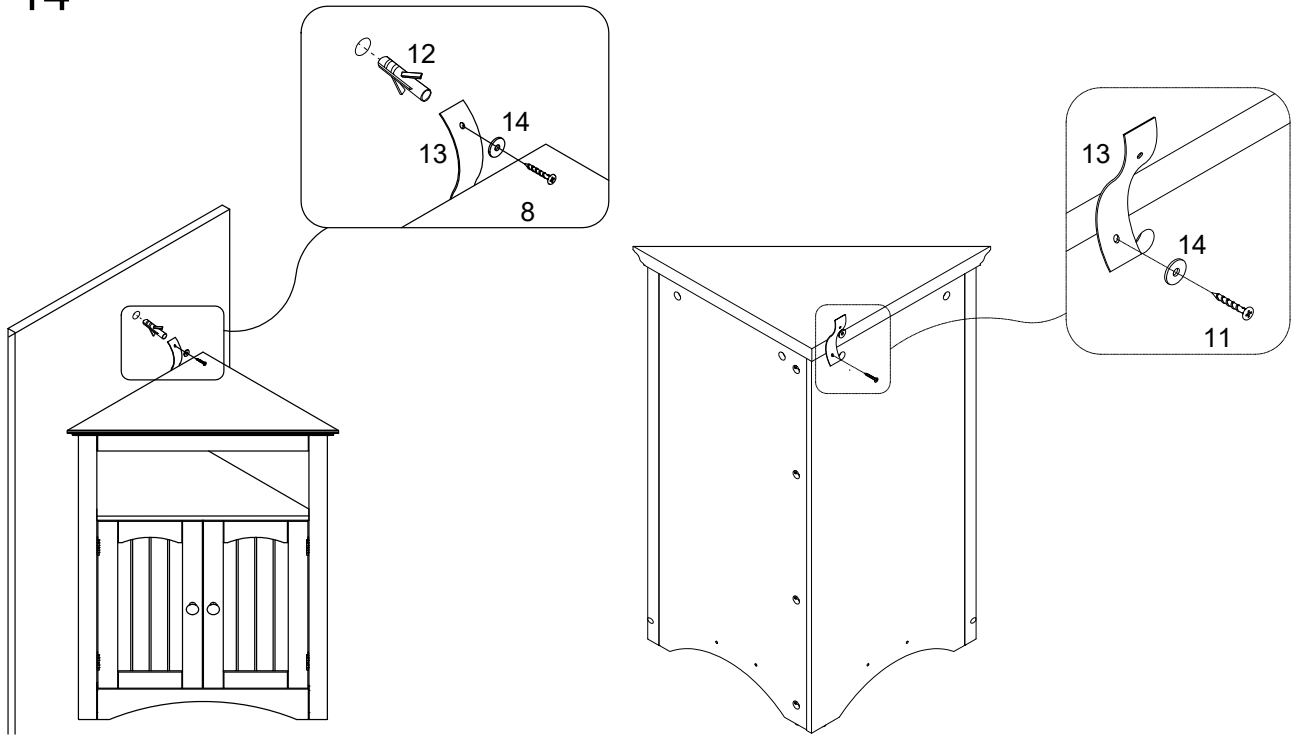

	6 x 4pcs
	7 x 4pcs

STEP14



	1pc
	1pc
	1pc
	1pc
14 	2pcs