

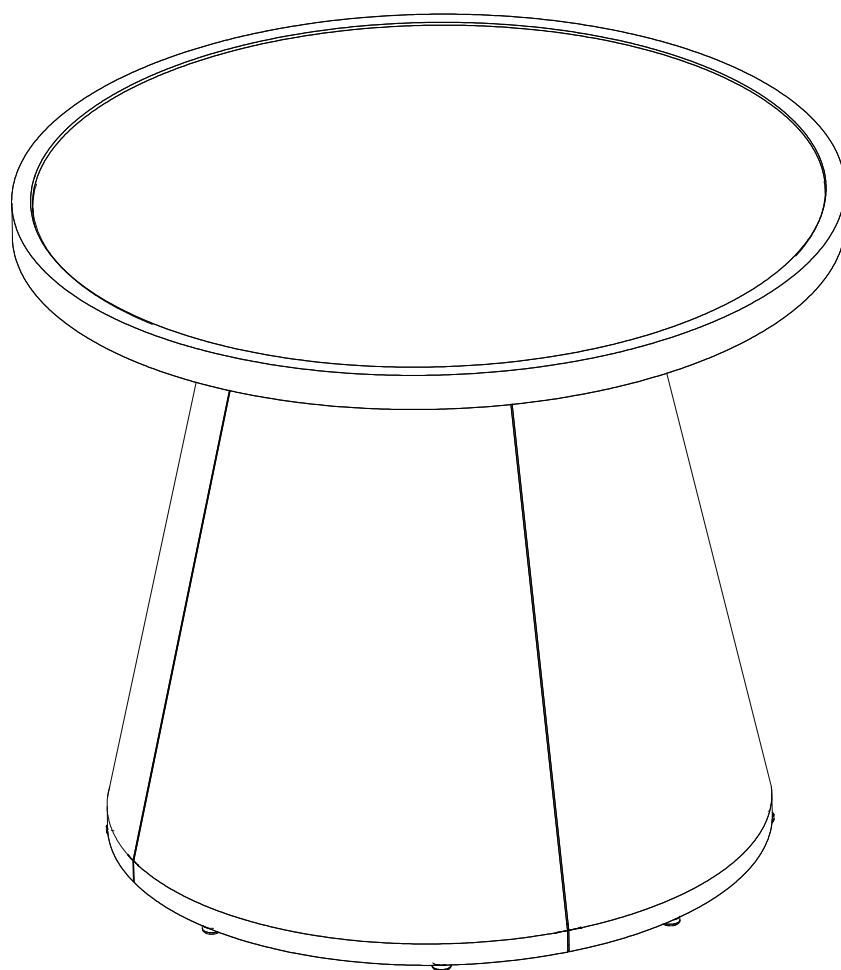

ASSEMBLY INSTRUCTION

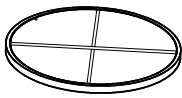

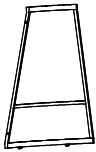

Dining Table

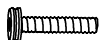
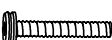

Component List

LABEL		DESCRIPTION	QTY
A		Table Top Frame	1
B		Table Legs	4
C		Table Top	1

Hardware List

LABEL		DESCRIPTION	QTY
①	 M6*30	Bolts	8
②	 M6*45	Bolts	4
③	 M6	Washers	20
④	 M6	Nuts	8
⑤	 M6	Wrench	1
⑥	 M6	Allen Wrench	1

1

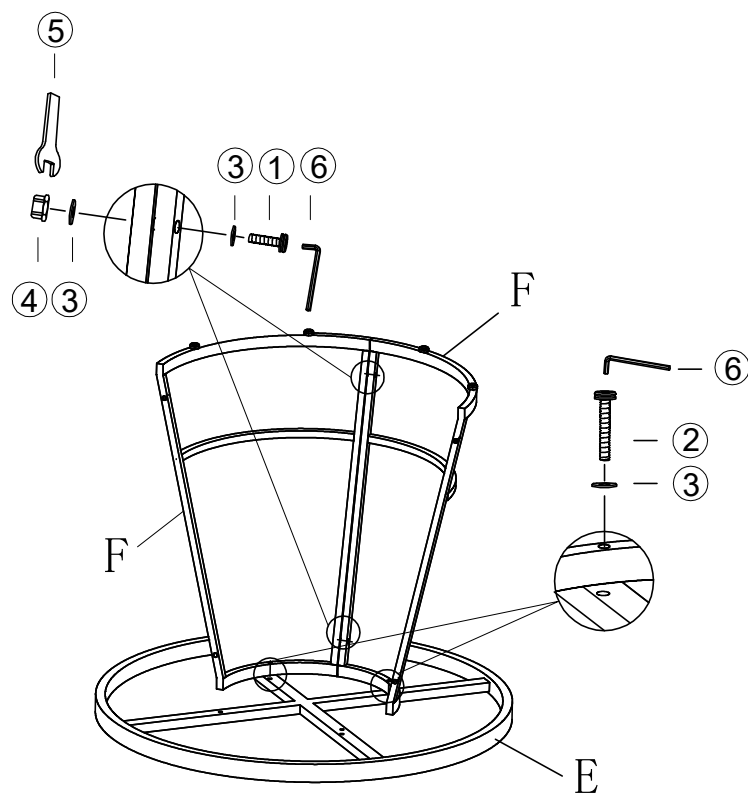
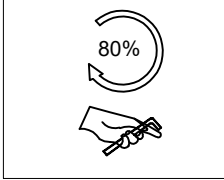
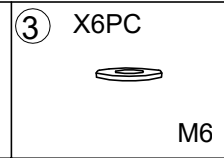
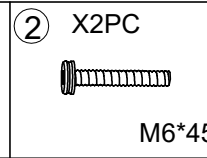
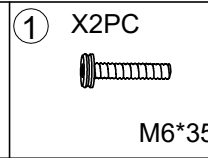
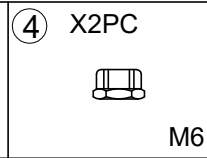
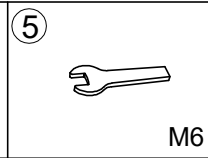
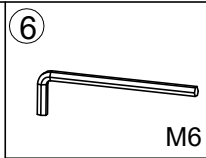

2

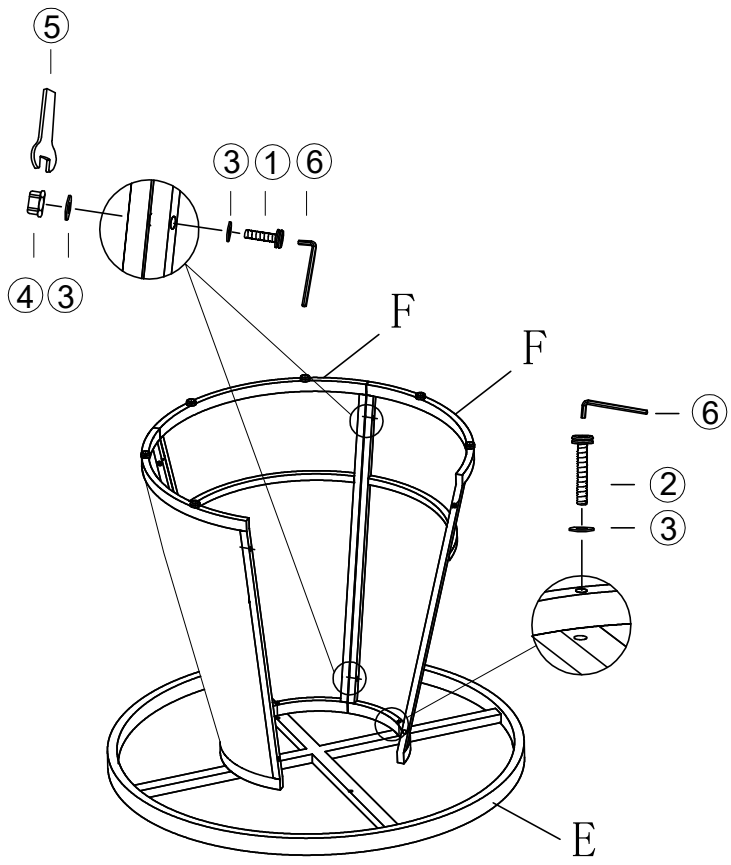
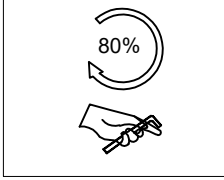
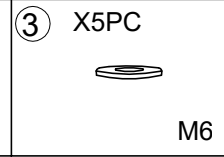
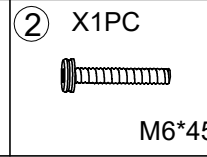
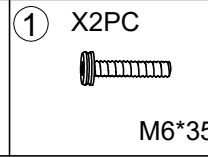
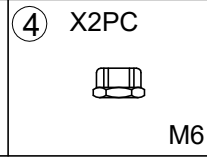
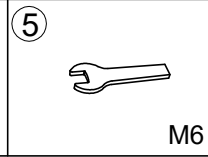
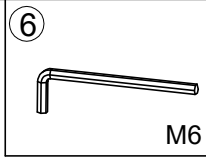

3

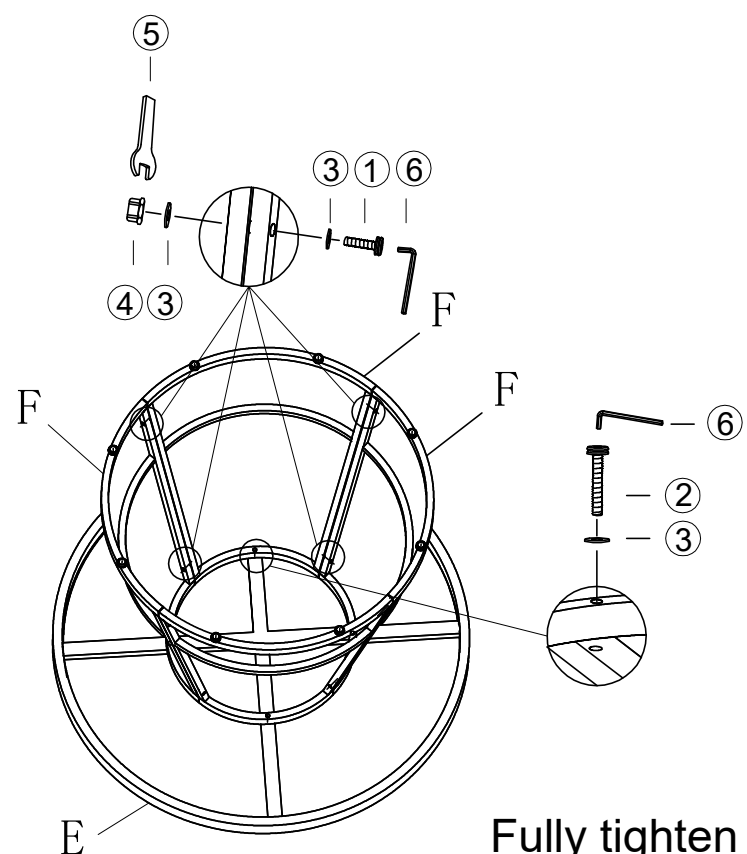
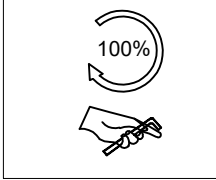
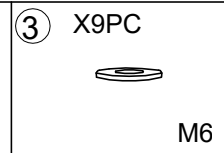
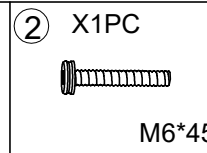
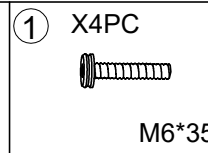
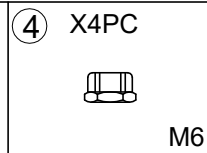
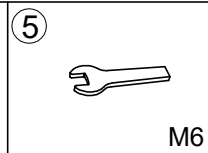
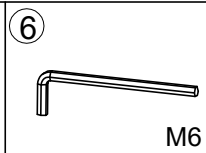

Fully tighten all bolts on this step!

4

