

ASSEMBLY INSTRUCTION

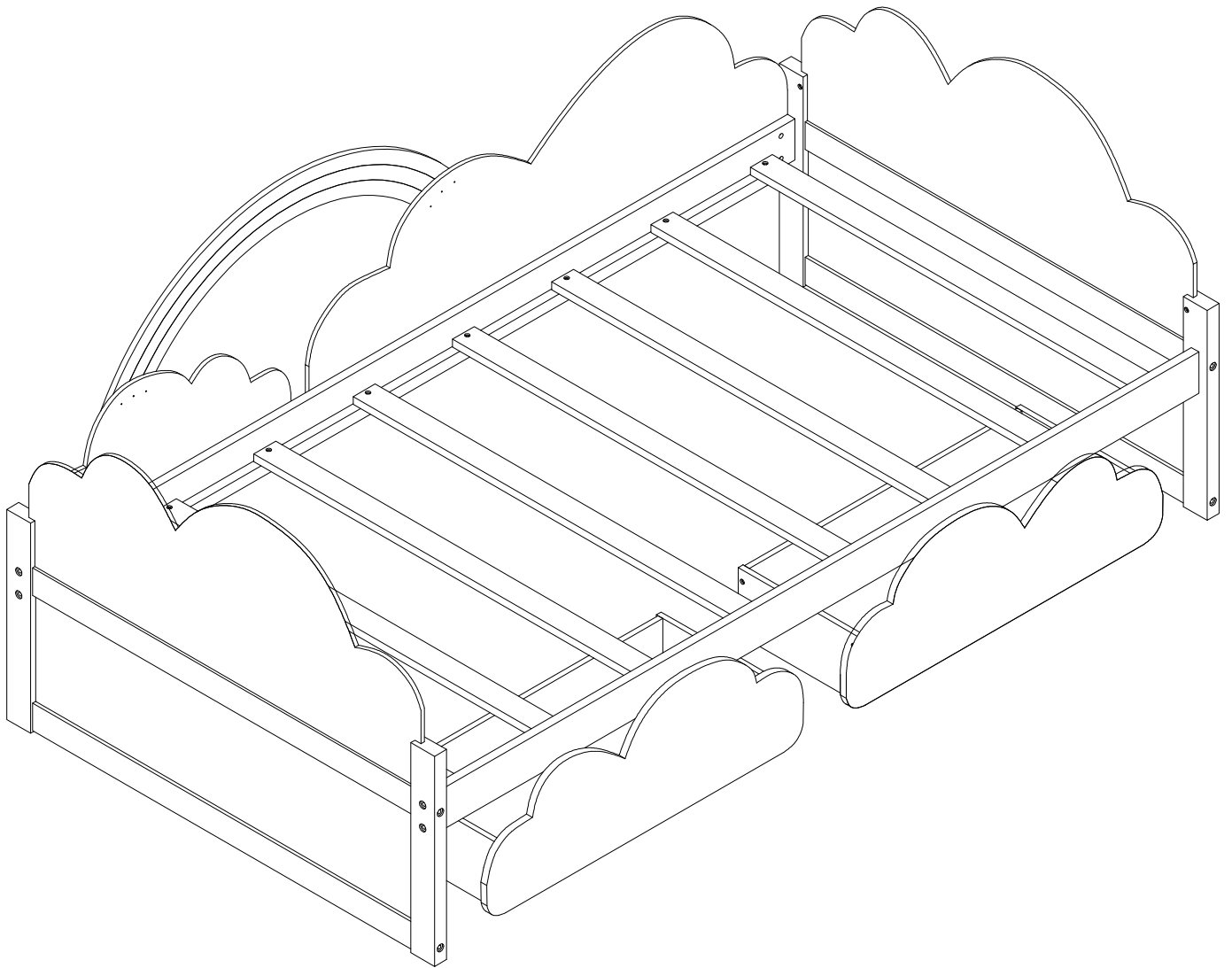

1. This bed is designed for use only mattress (es) meeting the following specifications on the upper bunk, and lower bunk







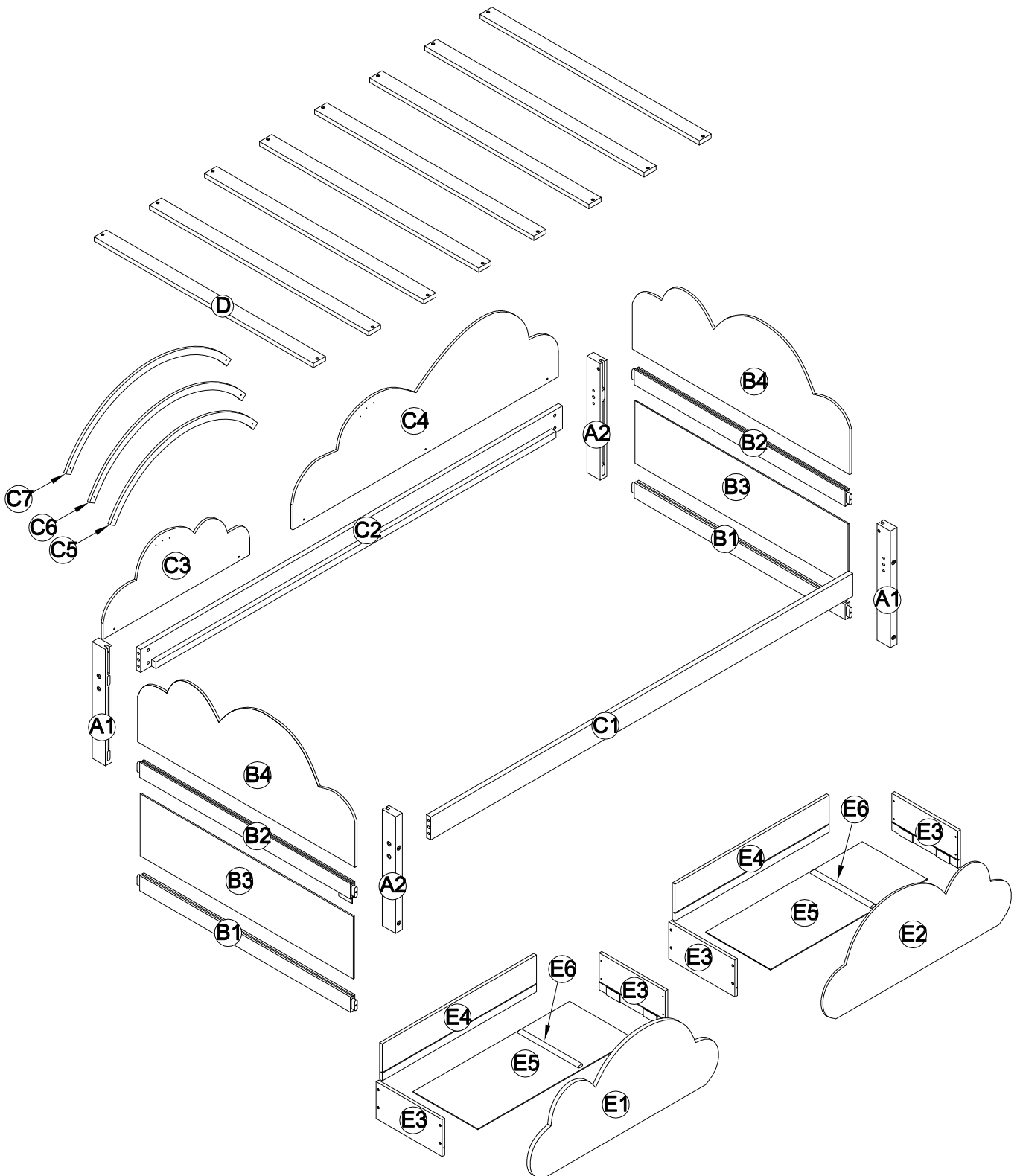

Bed Type	Length	Width	Thickness
<i>Twin Standard</i>	<i>74" - 75"</i>	<i>38 1/2"</i>	<i>8" max</i>

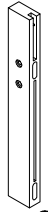
2. Replacement parts, including additional guardrails, maybe obtained from any of our (GIGACLOUD TECHNOLOGY (USA) INC. 18961 ARENTH AVENUE CITY OF INDUSTRY, CA, 91748) dealers
3. Follow the information on the warnings appearing on the upper bunk bed end structure and on the carton. Do not remove warning label from bed
4. Always use the recommended size mattresses or mattress supports, or both, to help prevent the likelihood of entrapment or falls.
5. Surface of mattress must be at least 5" (127mm) below the upper edge of guardrails
6. Do not allow children under 6 years of age to use the upper bunk.
7. Periodically check and ensure that the guardrail, ladder, and other components are in their proper position, free from damage, and that all connectors are tight.
8. Do not allow horseplay on or under the bed and prohibit jumping on the bed.
9. Always use the ladder for entering and leaving the upper bunkAlways use the ladder for entering and leaving the upper bunk.
10. Do not use substitute part. Contact the manufacture or dealer for replacement part
11. Use of a night light may provide added safety precaution for a child using the upper bunk..
12. Always use guardrails on both long sides of the upper bunk. If the bunk bed will be placed next to the wall, the guardrail that runs the full length of the bed should be placed against the wall to prevent entrapment between the bed and wall.
13. The use of water or sleep flotation mattresses is prohibited
14. STRANGULATION HAZARD - Never attach or hang items to any part of the bunk bed that are not designed for use with the bed; for example, but not limited to, hook, belts and jump ropes
15. Keep these instruction for future reference
16. Prohibit more than one person on upper bunk
17. We recommend assembling your bunk bed on the shipping carton to protect your floor or carpet
18. Be certain all staples are out of the box before beginning assembly on the shipping carton.

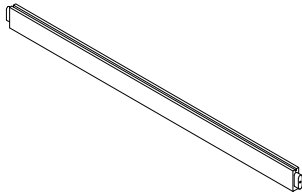

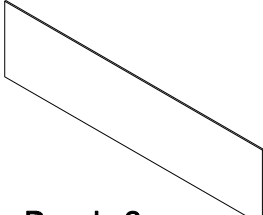
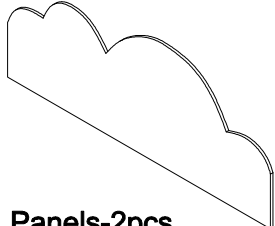
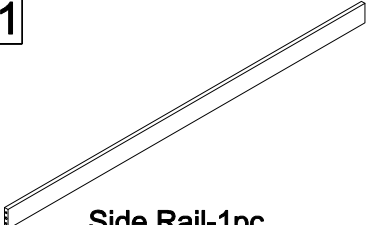
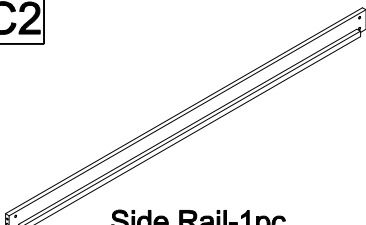

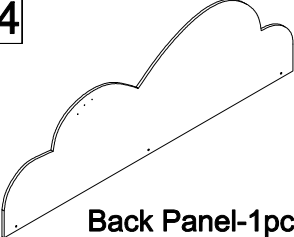
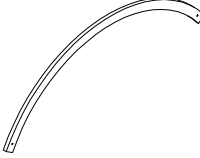
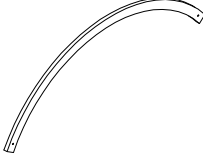
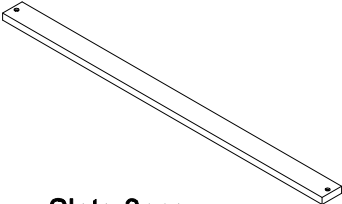
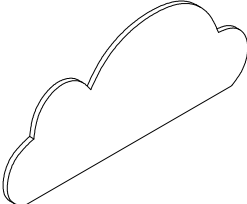

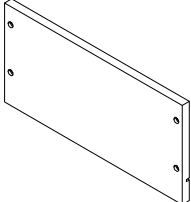
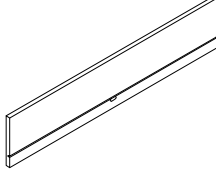
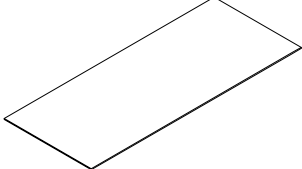
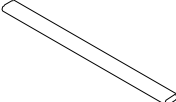
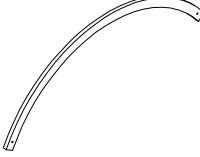
ASSEMBLY INSTRUCTION

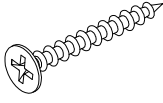
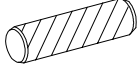
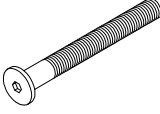

Part List & Hardware List

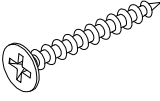
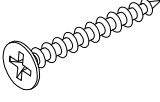
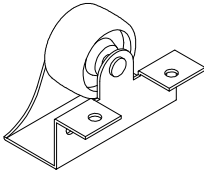
<p>A1</p>  <p>Legs-2pcs</p>	<p>A2</p>  <p>Legs-2pcs</p>	<p>B1</p>  <p>Wood Bars-2pcs</p>
<p>B2</p>  <p>Wood Bars-2pcs</p>	<p>B3</p>  <p>Panels-2pcs</p>	<p>B4</p>  <p>Panels-2pcs</p>
<p>C1</p>  <p>Side Rail-1pc</p>	<p>C2</p>  <p>Side Rail-1pc</p>	<p>C3</p>  <p>Back Panel-1pc</p>
<p>C4</p>  <p>Back Panel-1pc</p>	<p>C5</p>  <p>Rainbow Panel-1pc</p>	<p>C6</p>  <p>Rainbow Panel-1pc</p>
<p>D</p>  <p>Slats-8pcs</p>	<p>E1</p>  <p>Drawer-Front Panel-1pc</p>	<p>E2</p>  <p>Drawer-Front Panel-1pc</p>
<p>E3</p>  <p>Drawer-Side Panels-4pcs</p>	<p>E4</p>  <p>Drawer-Back Panels-2pcs</p>	<p>E5</p>  <p>Drawer-Bottom Panels-2pcs</p>
<p>E6</p>  <p>Drawer-Support Bottom Panels-2pcs</p>	<p>C7</p>  <p>Rainbow Panel-1pc</p>	

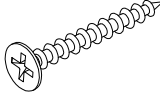
Hardware List

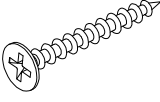
<p>1</p>  <p>Screws 1/4"x80 8pcs</p>	<p>2</p>  <p>M4 x 25 mm Wood Screws 9pcs</p>	<p>3</p>  <p>Ø10 x 40 mm Wood dowel 4pcs</p>
<p>4</p>  <p>Ø1/4" x 80 mm Hex-Head bolts 8pcs</p>	<p>5</p>  <p>Ø1/4" x 13 mm Horizontal-Hole bolts 8pcs</p>	<p>6</p>  <p>M4 x 30 mm Wood Screws 34pcs</p>
<p>7</p>  <p>M3.5x 12 mm Wood Screws 24pcs</p>	<p>8</p>  <p>Wheels 8pcs</p>	<p>9</p>  <p>Allen Key 1pc</p>
<p>10</p>  <p>M3.5 x 10 mm Wood Screws 4pcs</p>	<p>11</p>  <p>Steel Bracket 2pcs</p>	<p>12</p>  <p>M4 x 20 mm Wood Screws 6pcs</p>

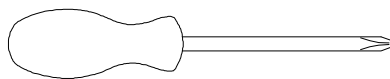

Assembly Tools Required (Not Included)

STEP 1: Following below illustration:

-Using hardware #1 connect A1,A2 Legs with B1,B2 Wood Bars and B3 Panel

1



2x4pcs

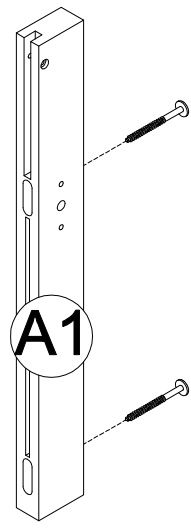

x2

B2

B3

B1

A1

1

A2

2

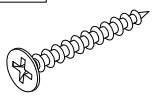

2x2pcs



x2

B4



2

STEP 2: Following below illustration:

STEP 3:

Following below illustration:

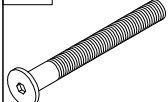
- Using hardware #4, #5 and dowel #3 to Assembly Frames (Completed on step 2) with C1,C2 Side Rails
- Look at detail view for more detail

5		4		3	
8pcs		8pcs		4pcs	

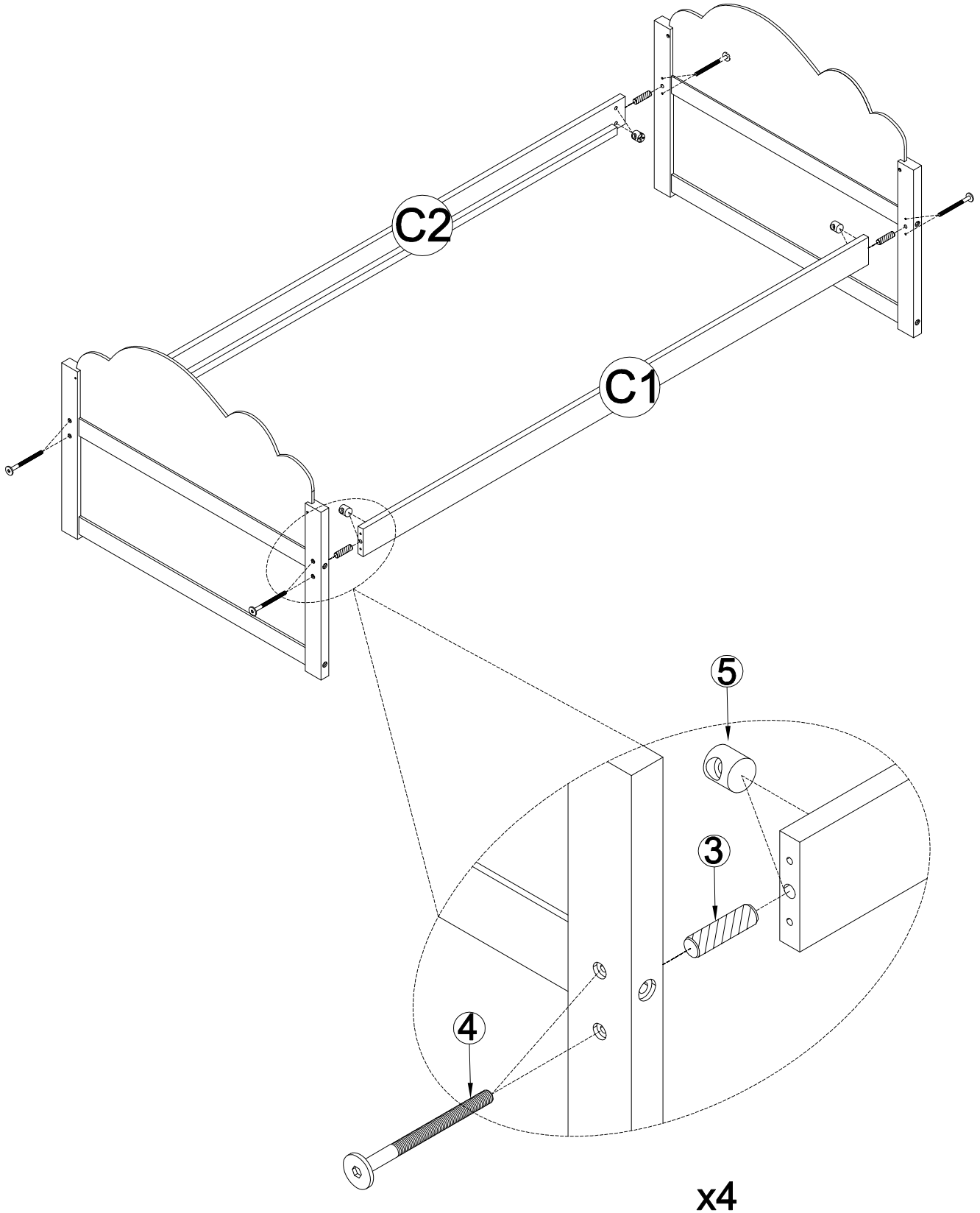

STEP 4:

Following below illustration:

- Using hardware #2 to Assembly Frames (Completed on step 3)
- with C3,C4 Panels and C5 Wood Bar
- Look at detail view for more detail

2

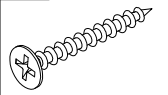

5pcs

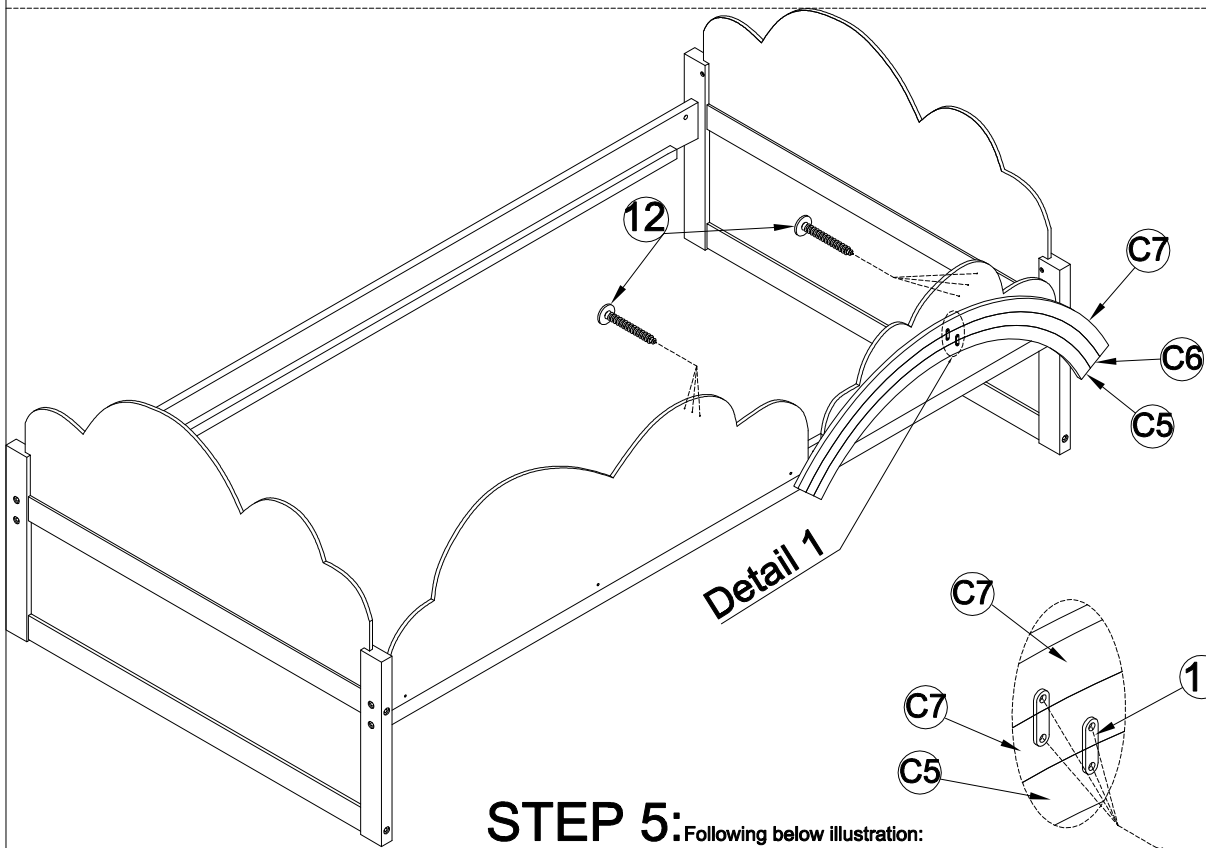
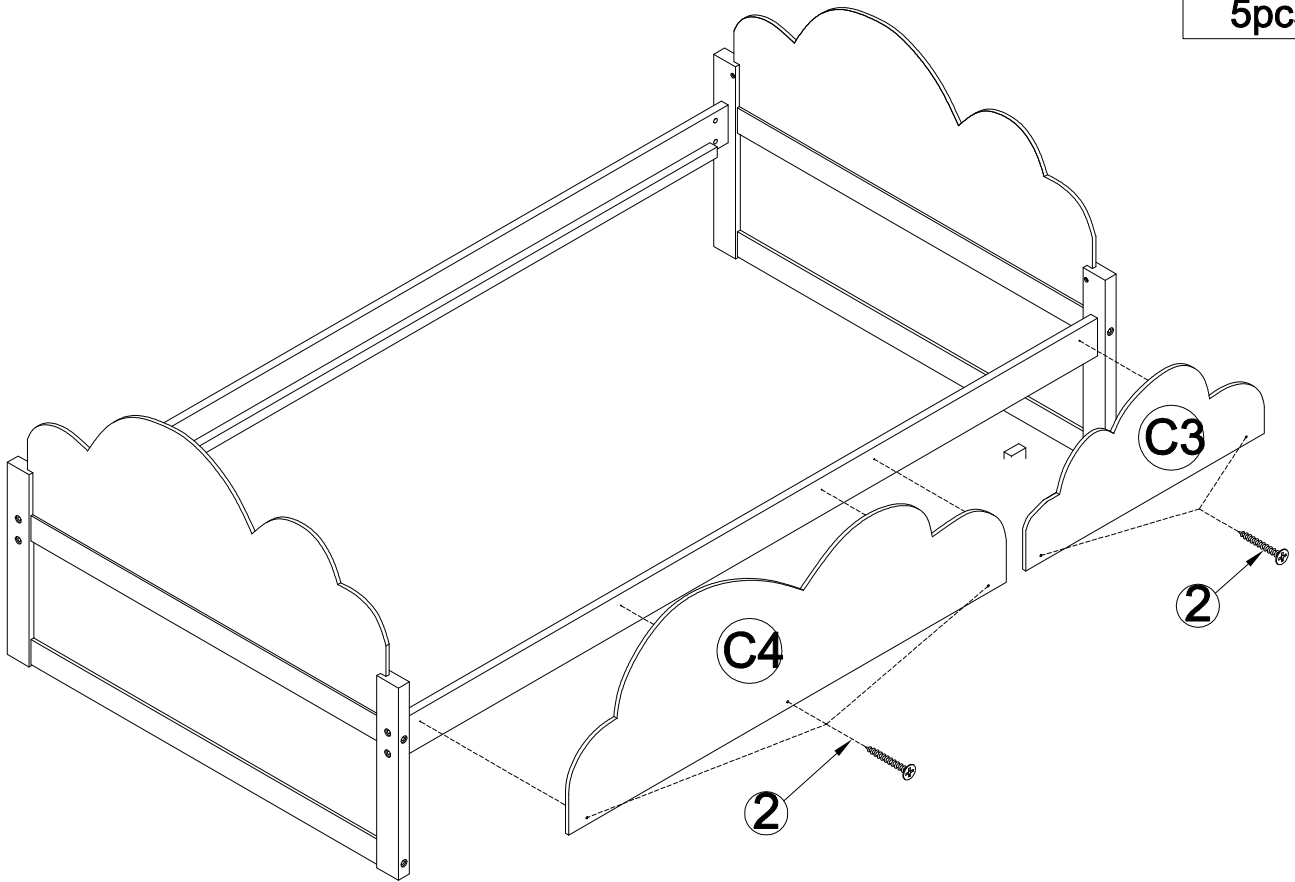

12



6pcs

10

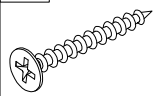

4pcs

11



2pcs

STEP 5:

Following below illustration:

- Using hardware #12,#10,#11 To Assembly Frames (Completed on step 4)
- with C5,C6,C7 Panel -Look at detail view for more detail

STEP 6:

Following below illustration:

-Screw 8 Slat D with Side Rail C1,C2 by using hardware #6.

6



16pcs

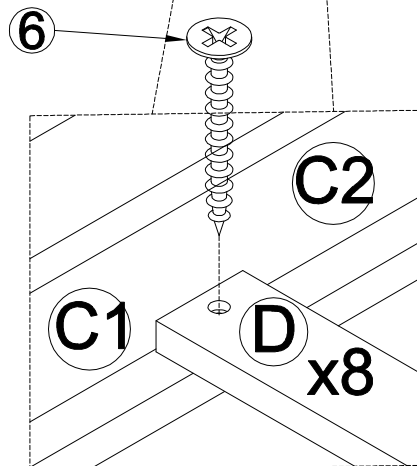
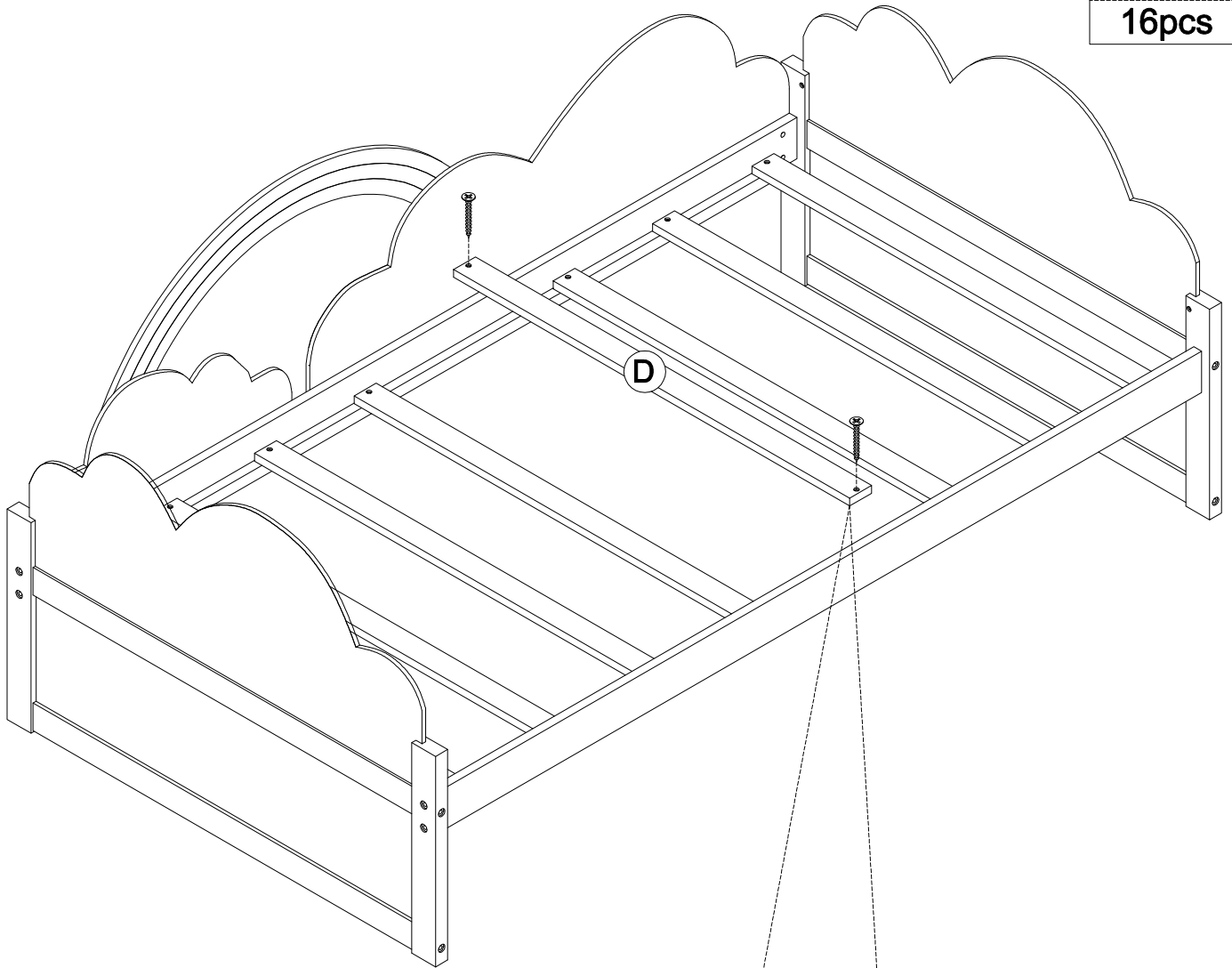

STEP 7-1:

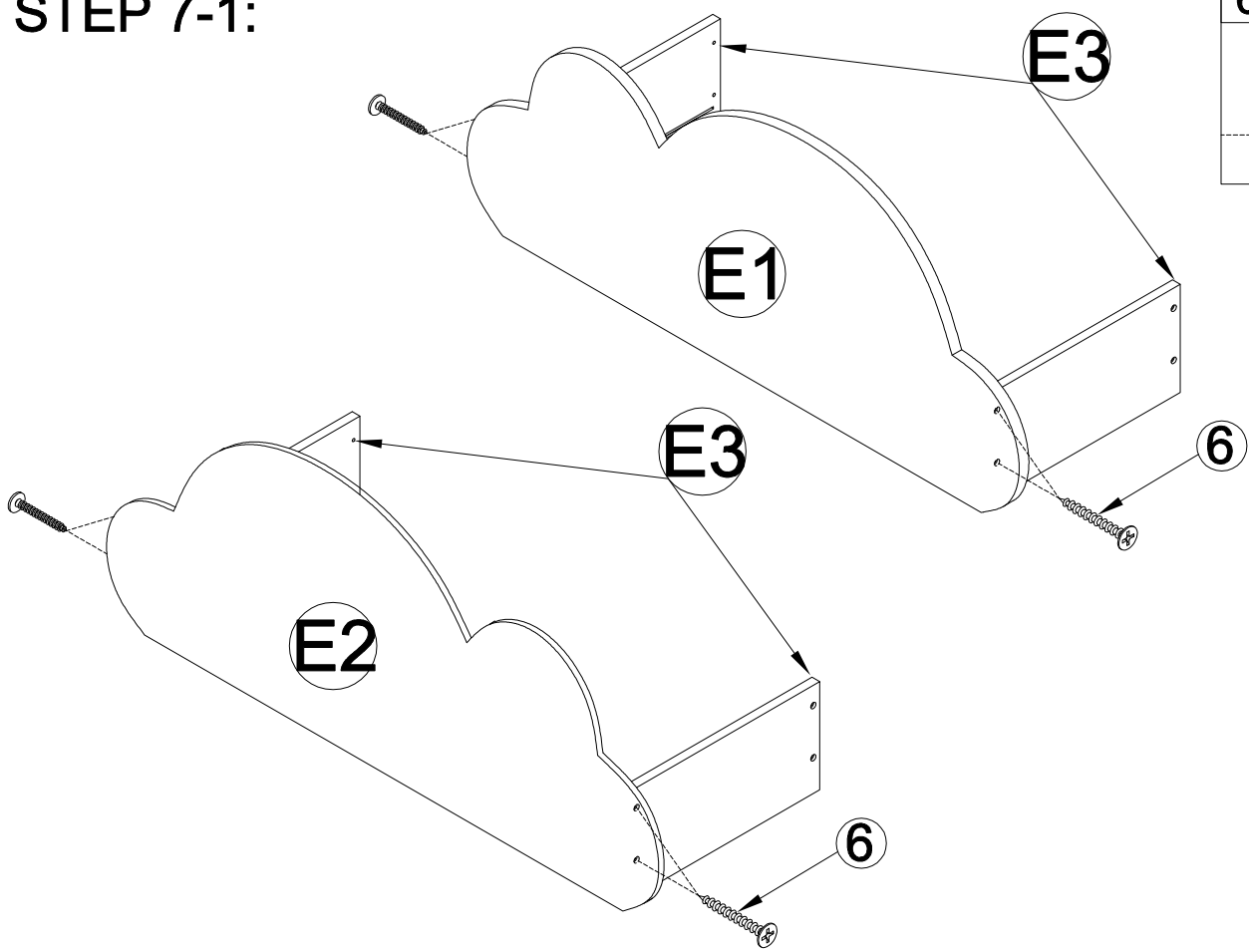

6



8pcs

STEP 7-2:

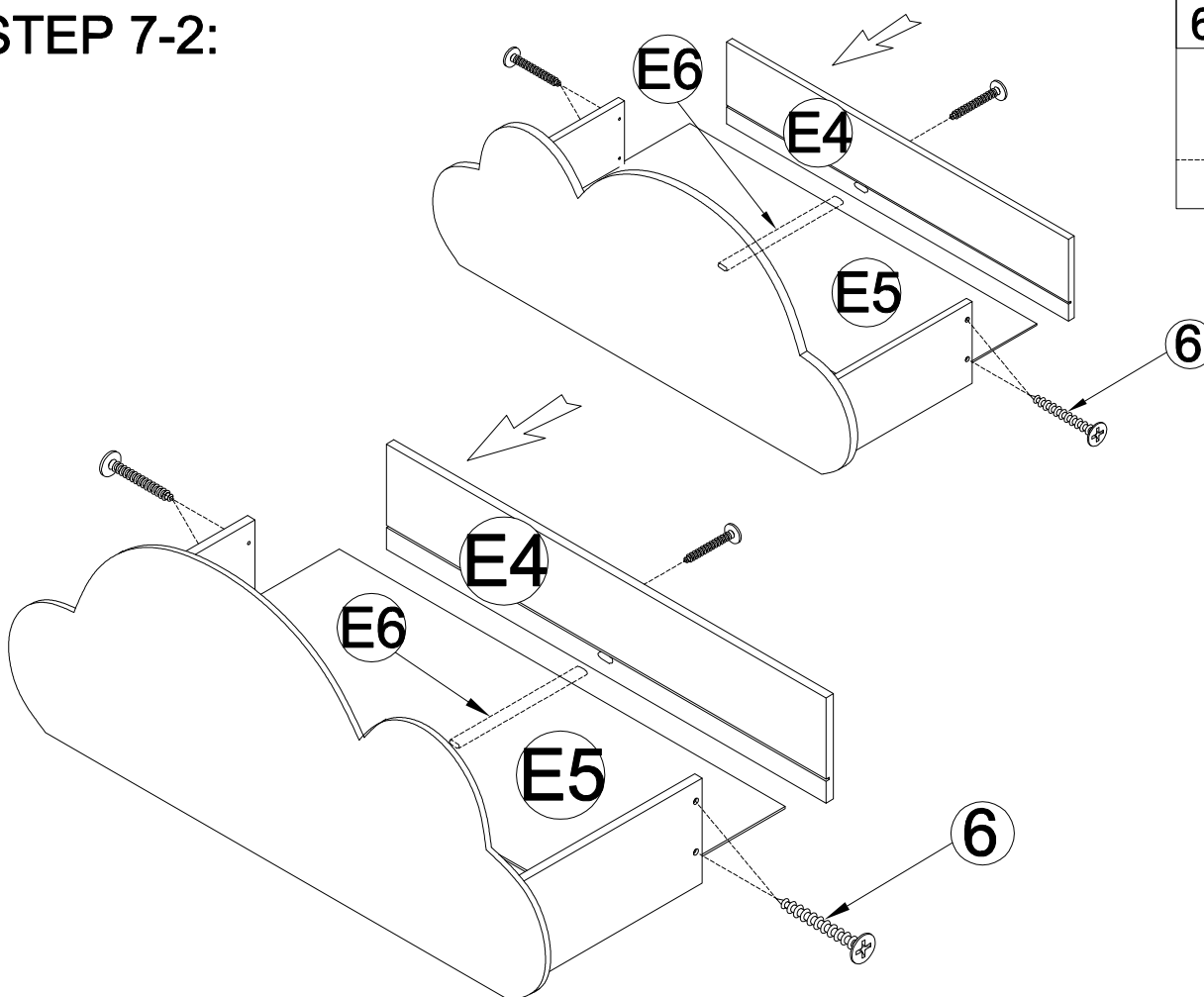

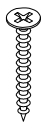

6



10pcs

STEP 7-3:

8	7
	
8pcs	24pcs

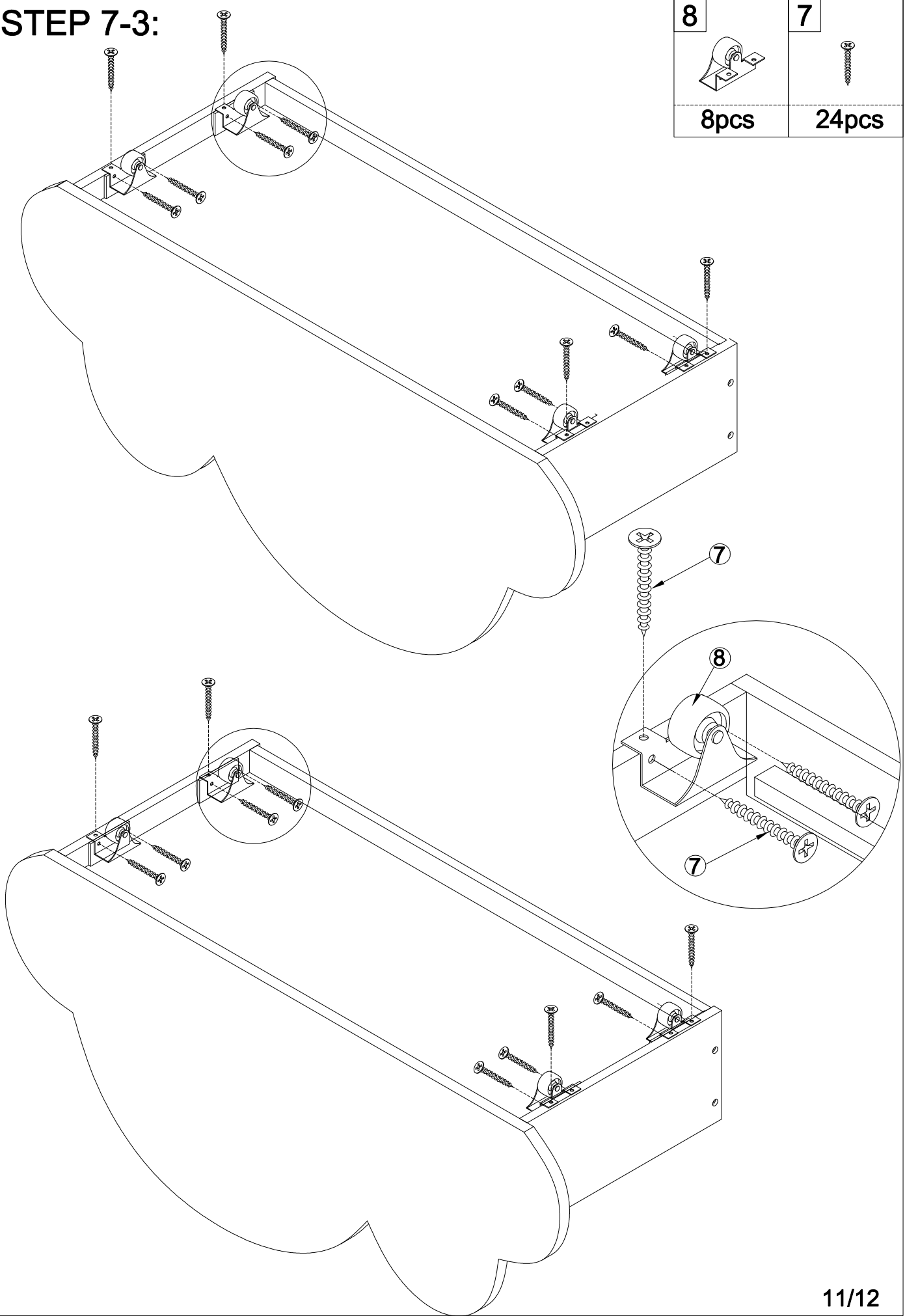

STEP 8: CONGRARULATION. YOU HAVE COMPLETED THE BED

Push 2 drawer into it position

