

INSTRUCTION MANUAL

OPT05 Smart Toilet

Thank you for choosing our product!

To ensure proper installation and safe use of your smart toilet, please read this manual carefully.

If you encounter any missing or damaged parts, please contact our customer service team.

Be sure to include your Order ID for faster service.

Customer Service Contact

✉ Email: support-cs@hkfoam.com

🕒 Response Time: Within 24 hours

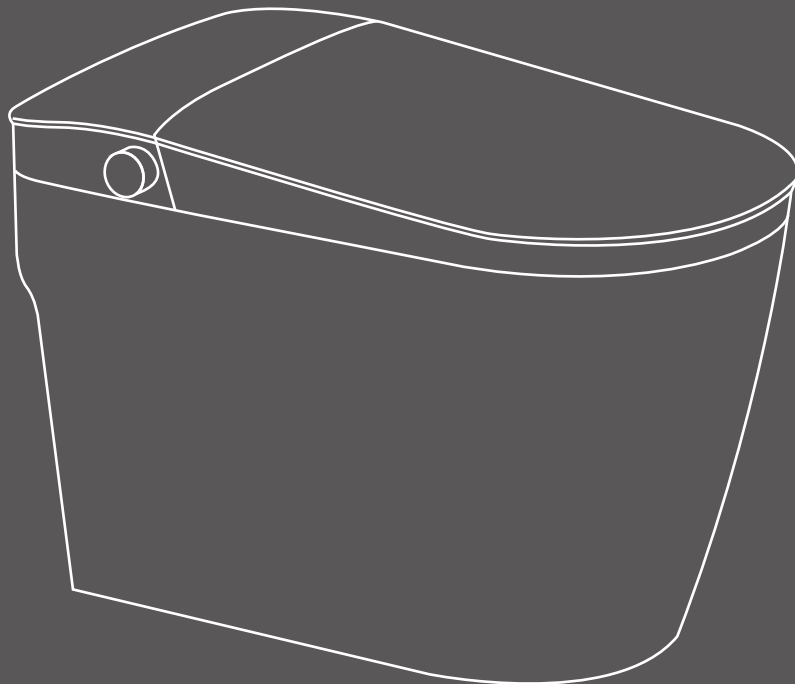

Contact Us

When missing parts? Or feeling stuck? you can contact us by scanning the whatsapp QR code below or via after-sales email (support-cs@hkfoam.com), we will reply you in time.

whatsapp



For after-sales issues,
please add this number: +86 13316904056

Product Installation Video

Please scan this QR code with your cell phone YouTube to watch the installation video instantly.



Catalogue

For any questions or support, please email: [support-cs@hkfoam.com]





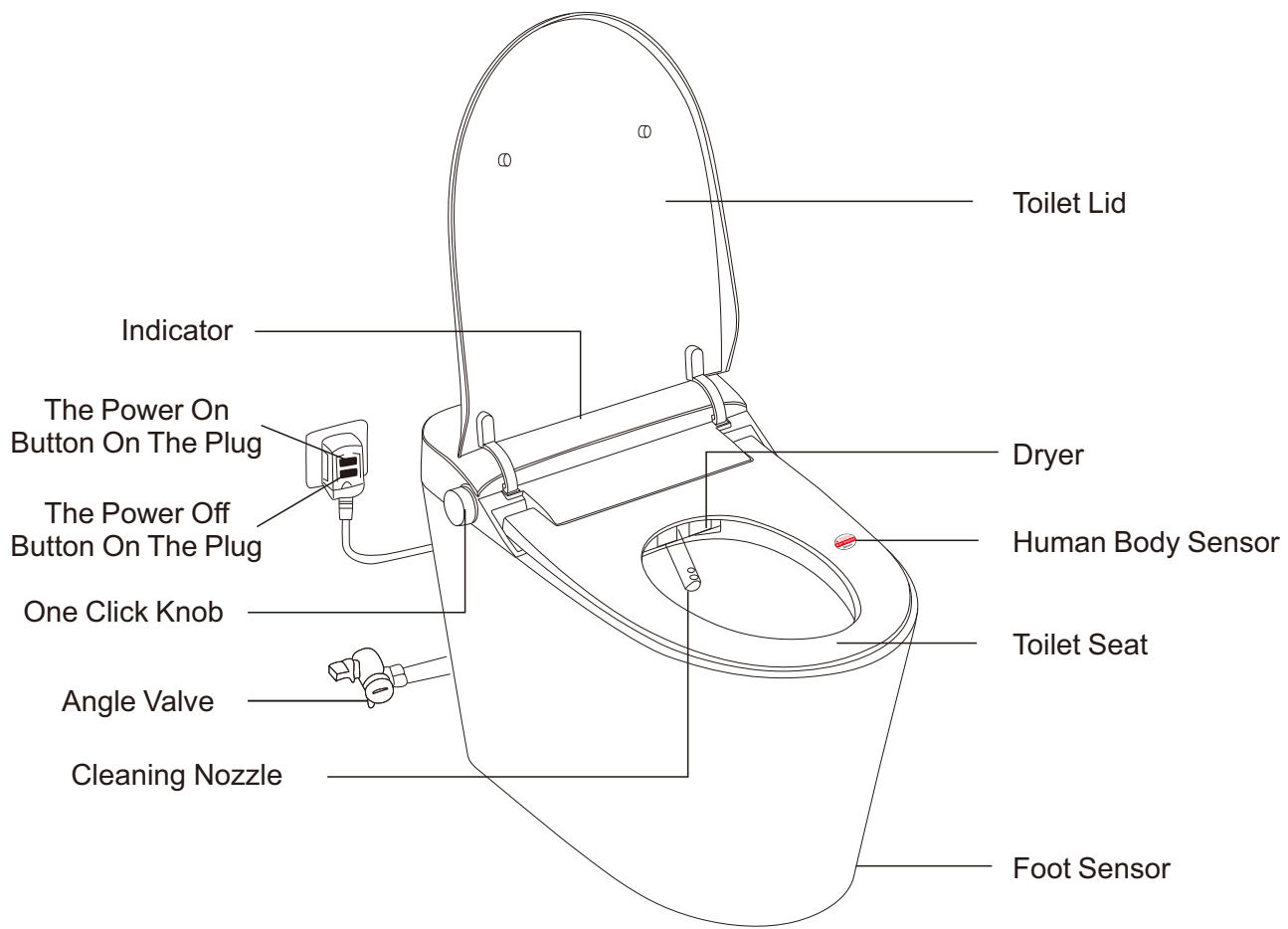





Component name	02
Hardware lists	02
Safety directory	03
Initial inspection before use	03
Safety cautions	04
Please be sure to observe the following	04
Safety and prohibited matters	05
Important safety warning – regular testing of the leakage protection switch	06
Daily cleaning and maintenance	07
Foot sensor user guide	08
Instructions for using the knob on the side of the toilet	09
Remote control instructions	10
Common fault diagnosis	13
Installation steps for smart toilet	15
Battery replacement and installation	19
Foam liquid replacement and installation	19
Product standard	21

Component name



Hardware Lists

Please check if all accessories listed below have been received.

1pc	1pc	1set	1set	1set	1pc	1pc	1set	1pc	1pc
									
flange ring	instruction	angle valve	remote control battery	16V battery	fixed disk	three links	fixed disk screws	foam solution bottle	foam liquid effervescent tablet
A	B	C	D	E	F	G	H	I	J

Warning: To avoid electric shock ⚠

1. Do not place the product in damp or wet locations.
2. Do not drop the remote control into water.
3. Do not spray water onto the product or into the power outlet.

Warning: To prevent burns, electric shock, fire, or injury ⚠

1. Young children and users insensitive to temperature should be accompanied by others when using this product. Turn off or lower the seat temperature when necessary.
2. Use this product only as described in the manual. Do not connect other equipment.
3. Do not continue to use the product if it is malfunctioning, damaged, or has been exposed to water. Send it to an authorized service center for repair.
4. Ensure that the power cord and wires are not damaged or exposed to heat.
5. Do not use this product under the influence of alcohol, medication, or in an unstable condition.
6. Do not plug or unplug the product or hoses while in use.
7. Do not use outdoors.

Initial inspection before use

Note: To ensure the normal use of the product, please follow the instructions to text.

1. Insert the power plug into a 110V AC outlet.
2. Check that the indicator on the digital display panel is illuminated.
3. Check that the inlet valve is turned on.
4. Ensure that the hose between the wall angle valve and the toilet inlet valve is properly installed.

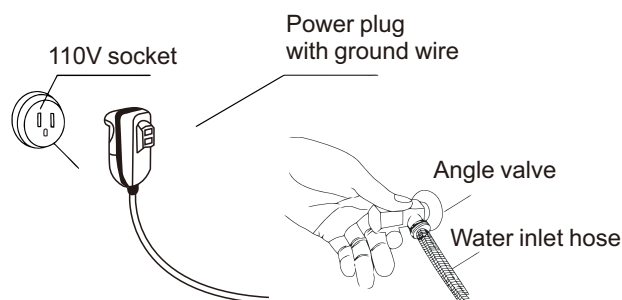

Caution: Items to Check Before Use

1. Check for water pipe leaks by wiping all connections with absorbent paper.
2. Press the seat near the seat sensor and check for a response sound.
3. Check that the damping structure operates normally.

Seating sensing position

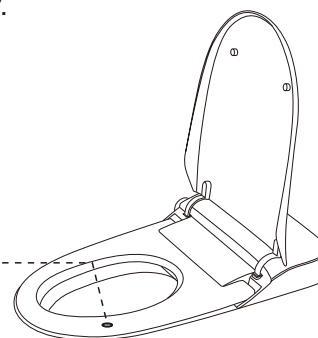

4. Verify that both the seat detection and foot detection functions are enabled.

Safety cautions

Note: please cautiously read before using

Please read carefully before using. The cautions listed here are related to safety and please follow. 

This product is an electrical appliance. Do not install it in locations where it may be splashed with water or exposed to high humidity. When used in a bathroom, ensure proper ventilation by installing a vent.

The power outlet should be installed as follows:

- The outlet must be positioned at least 11.8 in above the floor.
- Keep the outlet as far away from the bathtub as possible.
- The outlet circuit must be equipped with a high-sensitivity, fast-acting leakage protection switch (rated operating current ≤ 15 mA), or be protected by an insulated transformer with a capacity of 1.5–3 kVA.

Warning - Be sure to firmly connect ground wires 

This product uses a three-prong plug (with ground wire).

Risk of electric shock may occur in case of fault or electrical leakage.

If the wall outlet does not provide a ground connection, contact a licensed electrician.

Use only AC 110V power supply, and ensure wiring complies with relevant regulations.



Proper grounding of this product is required.

Without grounding, there is a risk of electric shock.

Note: Proper grounding means that the grounding resistance must be below 100 Ω , and the grounding wires of the switchboard must be copper wires with a diameter of at least 1.6 mm.

When installing in a bathroom, ensure that the power plug is sealed with silica gel for waterproofing.

Using the wrong power supply may cause a fire.

Please be sure to observe the following 

- Do not allow urine to splash onto the nozzle.
- Unplug the unit during thunderstorms.
- Do not flush the unit directly with water.
- Do not wipe the seat or cover with rough cloth or toilet paper. Use a soft damp cloth instead.

Please do not open the seat ring or cover violently.
- May cause cracking or malfunction.



Please take antifreeze measures by freezing.



Please do not put heaters near this product.

- Discoloration or malfunction will occur.



Please read carefully before using.

The cautions listed here are related to safety and please follow.



Must obey

Notice heat burn

- Please turn the seat temperature down or off when sitting on the toilet for a long time.
- Please set the temperature to room temperature when the following persons use the seat to dry gently.

- Children, the elderly, the sick, the disabled, etc.
- People who take sleeping pills, get drunk and get overtired.

When UV sterilization is activated, pregnant women should maintain a safe distance to avoid direct exposure or prolonged contact within the disinfection zone.

- Sterilization time: 30 seconds

Do not use any power source other than AC 110V

- It may start a fire

Keep cigarettes and other flammable objects away from the product

- It may start a fire

Please don't sprinkle water or rinse on product essence or the power plug

- May arouse a fire or get an electric shock
- May cause toilet break, damage or indoor seepage.

When long time didn't use, please pull out the power plug.

- For safety, please pull out the power plug
- For re-use, please drain water for one minute before use

Please do not flush other items except for urine and feces

- May cause then block, sewage outside over flows

Do not unplug the power plug with wet hands

- It may cause electric shock

Do not distort or damage the water inlet

- It may cause a leak

Do not use loose and unstable power sockets

- It may cause fire or electric shock



Prohibit

Do not continue to use the product when it breaks down

When the following occurs, please unplug the power plug, close the inlet angle valve stop the inlet.

- Ceramic WC is leaking
- Cracks appear
- Abnormal sound and smell
- Fume-off
- Abnormal heating
- The toilet is clogged
- If continued under the condition of failure, it may cause fire, electric shock or indoor seepage problems

Do not damage the power cord or toilet seat cable

- Don't pull
- Don't process
- Don't heat
- Don't forcibly bent
- Do not place heavy objects on the power cord and toilet seat connection line
- May cause fire, electric shock or short circuit. If the power supply is damaged, please contact a professional for repair

Do not disassemble, repair or transform the product without permission

- It may cause a fire or electric shock

Do not use extension wires. Otherwise, it may cause a fire or electric shock

- Do not connect wires or use extension cords, which may cause fire and electric shock.

Do not install this product in damp places such as bathrooms

- It may cause a fire or electric shock

Do not use unhealthy water

- May cause skin irritation and other problems

Important safety warning – regular testing of the leakage protection switch

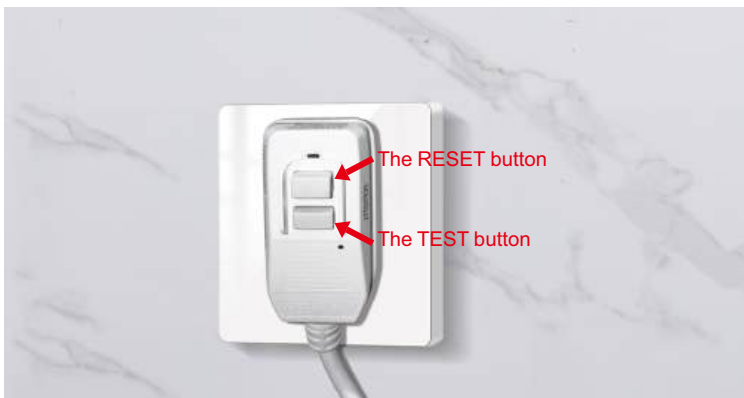

1. Importance of Testing

To ensure your safety, the leakage protection switch (hereinafter referred to as the “protection switch”) equipped with this product must always remain in proper working condition. Regular testing is the only way to verify that it functions effectively. We strongly recommend testing it at least once a month.

2. How to Test — Please follow these simple steps:

- ① Make sure the plug is connected to the power supply (plugged into an outlet and powered), but the unit does not need to be turned on.
- ② Firmly press the RESET button on the plug to connect the power.
- ③ Firmly press the TEST button on the plug. You should hear a clear “click,” and the switch’s trip mechanism will immediately activate, cutting off the power (the RESET button will pop out to the “OFF” position).

3. How to Interpret the Results

- ① If the switch trips normally: The leakage protection function is working correctly. After the test, press the RESET button again to restore normal power supply.
- ② If pressing the TEST button does nothing and power is not cut off: Stop using this product immediately! This indicates that the leakage protection function has failed, and continued use poses a risk of electric shock. Disconnect the appliance from the power supply at once and contact our after-sales service center or a licensed electrician for inspection or replacement.

4. Notes

- ① This test takes only a few seconds—please make it a regular habit.
- ② The test simulates a leakage scenario (such as electric shock) to verify the switch function. It will not damage the appliance.
- ③ This test allows users to confirm that the switch is working, but it does not replace a professional safety inspection by a qualified electrician.

Daily cleaning and maintenance

Note: During cleaning and maintenance, please be sure to unplug the power switch and power off

Smart toilet cleaning and maintenance methods

Please wipe it with a soft cloth dampened with water

- If the dirt is not removed in time, it will become difficult to clean, please wipe with water sometimes.
- Static electricity will absorb dust, resulting in the product black, dirty, water wipe can prevent the generation of static electricity.
- The ceramic body can be removed from the toilet seat to facilitate cleaning between the toilet seat and the ceramic body.

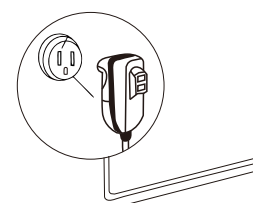

Unplug the power supply before maintenance

Cleaning and maintenance of spray head

If there is dirt in the nozzle. Please clean it with a small brush such as a toothbrush.

- Do not stretch and bend the spray head.

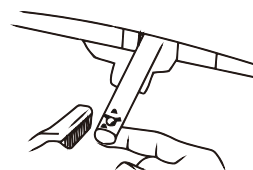



Must obey

Clean the dust on the power plug regularly

When cleaning, remove the power plug and wipe with a dry cleaning cloth.
- Poor insulation may cause a fire.



Must obey

Hip washing, women's washing, and drying require seating before use

Foot sensor user guide

Note: Please read the following carefully before use

Tip: The toilet foot sensor is not sensitive to darker colors or fails to sense. It is recommended to wear light-colored socks and shoes.

Open cover and seat by foot sensor

Close to the foot sensor, automatically open/close cover and seat (automatic flip cover)

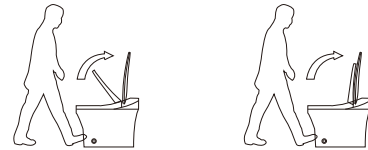

Radar automatic flip cover version

The cover opens automatically when people get close to it. The flushing automatically starts after the person leaving the seat, and cover closes automatically after the person leaves the seat for a while



Men's urinating operation

1. Put your feet in front of the (Foot Sensor) and the toilet lid will automatically flip up.

2. Put your feet in front of the (Foot Sensor) again and the toilet seat will automatically flip up.

3. The first situation: When you finish using, the toilet seat and toilet lid will automatically close and flush 90 seconds after you leave.

The second situation: when you put your foot in front of the (Foot Sensor), the toilet seat will automatically flip up. It takes more than 15 seconds during use. Then put your foot in front of the (Foot Sensor), the toilet seat and toilet lid closes automatically and flushes.



Instructions for using the knob on the side of the toilet

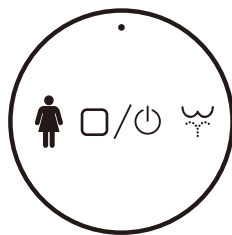

Note: Please read the following carefully before use



Power on/off: Press the knob for more than 3 seconds.



Power failure flushing: Connect the spare battery, press the knob for 3 seconds during power failure to start flushing.



Female cleaning: This function requires you to sit on the toilet seat. Rotate counterclockwise once to activate the female cleaning function. Rotate counterclockwise again to start moving and cleaning. After 120 seconds, the female cleaning will automatically stop. You can also press the knob once to stop it.



Buttock cleaning: This function requires you to sit on the toilet seat. Rotate clockwise once to start cleaning your bottom. Rotate clockwise again to start moving and cleaning. The buttock cleaning will automatically stop after 120 seconds. You can also press the knob once to stop it.



Warm air drying: This function requires you to sit on the toilet seat, press the knob twice in a row, and the toilet will flush automatically once, and then start the drying function. After 180 seconds, drying will automatically stop, or press the knob once to stop the drying function.



Toilet flushing function: When you are sitting (or not) on the toilet seat, press the knob once to activate the toilet flushing function. When you are using functions such as buttock cleaning or female cleaning or drying. Press this button to stop these functions in use.

Description of commonly used special functions

1. Automatically open the toilet lid - on/off setting instructions:

When the human body walks to the front of the toilet, the toilet lid will automatically open. If this function is not required, please follow the following steps: Press and hold the (LID) button on the remote control and hear one sound (di) → off, and hear two sounds (di,di) → on. (If this function is turned off, you can open the toilet lid via the foot sensor or the remote control).

2. Automatic foam shield - on/off setting instructions:

When you sit on the toilet seat, the foam shield will start automatically. This program is closed by default. If you need to enable this program, please follow the steps below: Press and hold the (POWER) key on the remote control for off the toilet. Within 3 seconds of closing the toilet, press (FULL FLUSH) on the remote control, one sound (di) is turned off, and hearing two sounds(di,di) is turned on. then press the (POWER) button on the remote control again for toilet power on status.(If this function is turned off, you can turn on the foam shield by pressing the (FOAM) button on the remote control) (Note: This function can only be used after installing the foam liquid according to the installation steps on page 19).

3. Pre-rinse function (wet wall) - on/off setting instructions:

The wall-moistening function refers to the fact that when someone sits on the toilet seat, the toilet will automatically flush a small amount of water once to pre-moisten the inner wall of the toilet and prevent feces from sticking to it on the toilet. This function is turned off by default at the factory. If you want to use this function, you can do it this way: Press and hold the (POWER) key on the remote control for off the toilet. Within 3 seconds of closing the toilet, and then press the (FRONT/MOVE)button on the remote control. one sound (di) → pre-rinse off , two sounds (di,di) →pre-rinse on. then press the (POWER) button on the remote control again for toilet power on status.

4. Automatic UV sterilization - on/off setting instructions:

After using the toilet and the toilet cover is closed, the sprinkler will automatically perform Uvsterilization for a duration of 30 seconds. This program is turned off by default. If you need to enable this program, please operate as follows: Press and hold the (POWER) button on the remote control for 5 seconds to close the toilet. Within 3 seconds after closing, press (SEAT TEMP) on the remote control and hearing one sound (di) is turned off, and hearing two sounds (di,di) is turned on. (If this function is turned off, you can turn on UV sterilization by pressing the (UV) button on the remote control).

With Auto Open Cover Flip Remote Control

Note: Please read the following carefully before use

Remote Control Pairing:

If the remote control does not respond the first time you use it, you will need to code the remote control to the toilet. First, press the (TEST) button on the plug to turn off the power, then press the (RESET) button on the plug to turn on the power, within 5 seconds after turning on the power, turn the knob counterclockwise and hold for 5 seconds. When you hear one beep (di), immediately press any button on the remote control. When you hear another beep (di), It means the remote control has been successfully paired with the toilet.

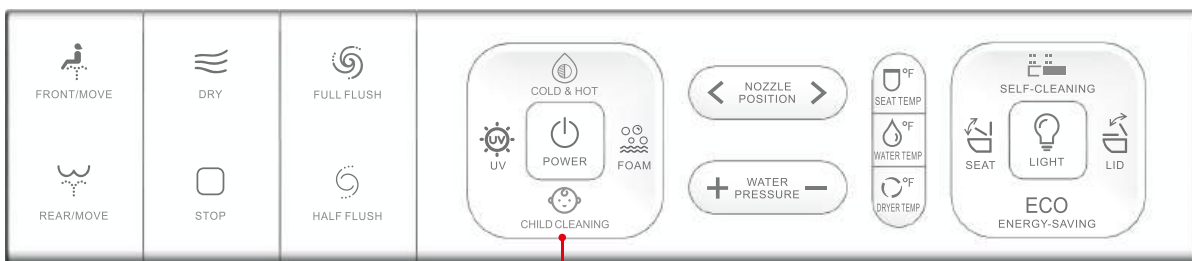

Note: Within 5 minutes of using child mode, only rear wash, feminine wash, or drying functions can be used.
To use other functions, press the (CHILD CLEANING) button again to exit child mode.



FRONT/MOVE

This function requires you to sit on the toilet seat, press the (FRONT/MOVE) button, (Cleaning Nozzle) will move out to start female cleaning, press the (FRONT/MOVE) button again, (Cleaning Nozzle) will move to clean, and then automatically stop female cleaning after 120 seconds or press the (STOP) button.



REAR/MOVE

This function requires you to sit on the toilet seat, press the (REAR/MOVE) button, the (Cleaning Nozzle) will move out to clean the buttocks. Press the (REAR/MOVE) button again, and the (Cleaning Nozzle) to start moving and cleaning, After 120 seconds, hip cleaning will automatically stop, or press the (STOP) button.



DRY

This function requires you to sit on the toilet seat, press the (DRY) button, and the toilet will automatically flush once, and then start the drying function. After 180 seconds, drying will automatically stop, or press the (STOP) button.



STOP

Pressing the (STOP) button can stop the operation of functions such as female cleaning, buttock cleaning and drying.



FULL FLUSH

Press the (FULL FLUSH) button to activate the full flush function of the toilet.



HALF FLUSH

Press the (HALF FLUSH) button to activate the half-flush function of the toilet.



COLD & HOT

This function requires you to sit on the toilet seat. When using the female cleaning or buttock cleaning function, press the (COLD & HOT) button to activate the alternating cleaning of "cold water" and "normal temperature water".



UV

Press the (UV) button to start UV sterilization. After 30 seconds, the UV sterilization function will be automatically stopped or press the (STOP) button. (Note: When using ultraviolet rays to sterilize, pregnant women should not get close to them.)



POWER

Press (POWER) for 5 seconds to turn off the toilet power.



FOAM

When you are sitting (or not sitting) on the toilet, press (FOAM) to activate the foam shield function. (Note: This function can only be used after installing the foam liquid according to the installation steps on page 19.)

CHILD CLEANING

This feature requires Children to sit properly and press the (CHILD CLEANING) button, then press the (FRONT/MOVE) button again to start the cleaning for "90 seconds", or press the (REAR/MOVE) button to start the cleaning for "90 seconds". After the cleaning is completed, the toilet will automatically flush and activate the warm air drying function for "90 seconds".

Note: Within 5 minutes of using child mode, only rear wash, feminine wash, or drying functions can be used. To use other functions, press the (CHILD CLEANING) button again to exit child mode.

NOZZLE POSITION

During the buttocks or female cleaning process, press this button to adjust the position of the (Cleaning Nozzle) forward. (repeatedly press the button to move the nozzle forward)

NOZZLE POSITION

During the buttocks or female cleaning process, press this button to adjust the position of the (Cleaning Nozzle) backward. (repeatedly press the button to move the nozzle backward)

WATER PRESSURE

During the cleaning process of buttocks or female, press the (+) button to increase the water pressure of (Cleaning Nozzle), and it can be adjusted to weak, medium, strong, and strongest.

WATER PRESSURE

During the cleaning process of buttocks or female, press the (-) button to reduce the water pressure of (Cleaning Nozzle), and it can be adjusted to strongest, strong, medium and weak.

SEAT TEMP

Press the (SEAT TEMP) button to adjust the temperature of the toilet seat. There are 4 Settings available. The first setting is: normal temperature, the second setting is: 93°F, the third setting is: 99°F, and the fourth setting is: 104°F.

WATER TEMP

During the cleaning process of buttocks and female, press the (WATER TEMP) button to adjust the water temperature of (Cleaning Nozzle). There are 4 levels of water temperature adjustment, the first level is normal temperature, the second level is 93°F, the third level is 99°F, and the fourth level is 104°F.

DRYER TEMP

When you are using drying, Press this key briefly to continuously switch the wind temperature. You can switch to the first, second, third or fourth level.

SELF-CLEANING

Press the (SELF-CLEANING) button, (Cleaning Nozzle) will move out and water will come out for cleaning, and then you can use a brush or rag to clean (Cleaning Nozzle).

SEAT

Press the (SEAT) button and the toilet seat will open automatically. Press it again and the toilet seat will close automatically.



LID

Press the (LID) button and the toilet lid will open automatically. Press it again and the toilet lid will close automatically.

ECO ENERGY-SAVING

Press (ENERGY-SAVING) to activate the energy-saving mode of the toilet.



LIGHT

When not sitting down, press the (LIGHT) button to turn on or off the night light in the toilet. When you are sitting on the toilet seat, press the (LIGHT) button to turn on or off the ambient light on the toilet seat.

Common fault diagnosis

Note: If similar fault is found, please read the following solution or contact after sales

Fault phenomenon	Fault analysis	Fault handling
Product unavailable	Check to see if the power/socket is loose	Please check the circuit
	Whether there is leakage (the display light of leakage protection plug is not on)	Remove the power plug from the socket and replug it later. Press the reset switch of the leakage protection plug. If the toilet still cannot be operated, please unplug the power plug and entrust the repair.
No water with spray	Check if water is cut off	Pending resumption of water supply
	Check that the angle valve is closed	Open the angle valve
	Check if the inlet filter is blocked	Clean or replace the filter
	Check the inlet pipe for bends	Exclude the intake bend
Cleaning insufficient rigidity	Check whether the cleaning pressure is at the lowest level	Refer to the instruction manual for regulating the water pressure
	Check if the inlet filter is blocked	Clean or replace the filter
Spray water disorderly	Abnormal operation	Unplug the plug for one minute and then switch it back on
Water temperature is not enough	Check whether the water temperature is set low	Adjust the water temperature according to the instructions

The washer often drips water	Solenoid valve failure	Please get professional maintenance technicians
Misoperation of remote control	Check whether the battery level of the remote control is too low	Please replace the battery
Drying/seat temperature too low/no heating	Check whether the temperature is set at low or normal temperature	Adjust the temperature according to the instruction
	Check if the power saving mode is enabled	Refer to the manual to choose to turn off the power saving function
Seat/cover falling too fast	Failure of damping drop function	Please get professional maintenance technicians
The cleaning function can not be used normally	Whether the area under the seat is clear of any objects	Remove the hard objects
	Whether the body's sensing area is covered	Adjust the body sensing area of the seat cover
	Whether the power supply is restored during the power failure	Unplug the plug for one minute and then switch it back on
	Whether your skin is in full contact with the seat's sensor area	Sensor failure, please get professional maintenance technicians
Seat/cover cannot be opened or closed *Only for automatic flip machines	Failure of automatic damping function	1. Disconnect the plug for one minute and switch it back on 2. The above treatment is invalid, please ask professional personnel for maintenance
Low water pressure does not flush clean	Filter mist blocking	Clean the filter according to the instruction
	Pipe bending	Observe whether the connection line bends and keep the water supply line smooth
No siphon flushing is not clean when water pressure is normal	Air escapes from the sewage outlet	Please get professional maintenance technicians
	The S-bend is blocked	Please buy water pipe dredger in the market for dredging
Poor flush performance with normal water pressure	Flush valve failure	Ask professionals for maintenance

Installation steps for smart toilet

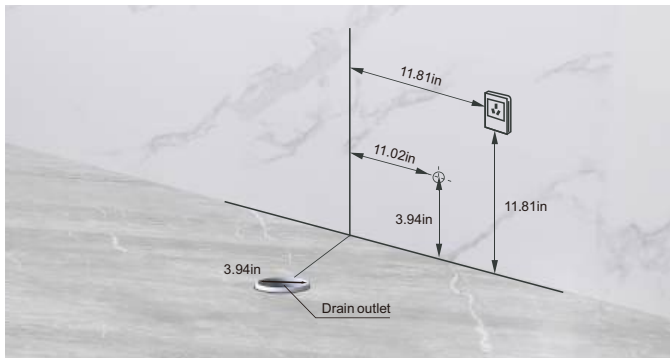

The confirmation of the installation environment.



1. The confirmation of the installation environment: The measurement distance is 11.81 in or greater.



2. Place the fixed disk into the drain outlet and mark the screw hole positions.



3. Take off the fixed disk and drill four holes for screws.



4. Put the screws into the holes.

Corresponding to the following accessories/quantities:



5. Place the fixed disk into the drain outlet and tighten the screws to secure it.

Corresponding to the following accessories/quantities:





6. Install two long screws as shown in the picture below.

Corresponding to the following accessories/quantities:



7. Install the white snap onto the positioning screw.

Corresponding to the following accessories/quantities:



8. Lock the gasket screws.

Corresponding to the following accessories/quantities:



9. Gently turn the toilet over to access the base and install the flange ring.



10. Apply a layer of silicone sealant to the base of the toilet. (The silicone sealant adhesive in the picture needs to be purchased by oneself.)



11. Move the toilet to the location where it will be installed.



12. Fix the white screws into the screw holes on both sides of the ceramic.

Corresponding to the following accessories/quantities: 



13. Lock the silver fixing screws on both sides.

Corresponding to the following accessories/quantities: 



14. After the screws are tightened, install the white decorative cover.

Corresponding to the following accessories/quantities: 



15. Apply some silicone sealant to fix the toilet and insulate the outside dirt from entering.
(The silicone sealant adhesive in the picture needs to be purchased by oneself.)

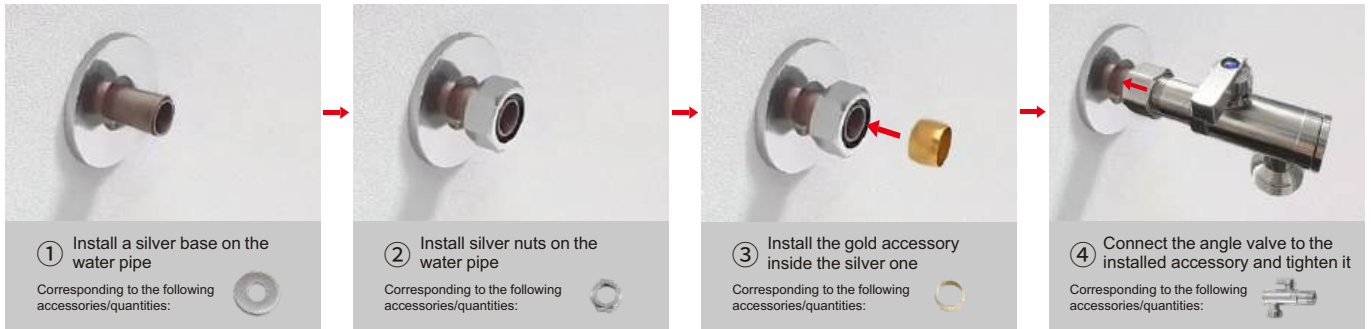

Our angle valve is a standard American-controlled angle valve. If the valve is incompatible with your plumbing setup, please contact us in time. Email: support-cs@hkfoam.com, we will solve your problem as soon as possible.



16. Connect the three-way valve to the Angle valve, unscrew the three-way nut, insert the cleaning water inlet pipe into the nut, then forcefully insert it into the three-way interface and tighten the nut.



17. Finally connecting the flexible tube to the inlet angle valve and turn on the angle valve switch.
Attention: The above installation steps are universal for all models of toilets and are only for your reference during installation. If you find that the details in the pictures do not match the actual product, please ignore them!



18. Plug in the power supply, press the (RESET) button forcefully. Release the button when you hear a (di) sound. If the toilet display remains constantly on, it indicates that the power has been successfully turned on. Press the (TEST) button to turn off the power.

Battery replacement and installation

If the equipment is powered off, you can install a spare battery and discharge it. Note: If the spare battery runs out, you can purchase a 16-volt battery and replace it by following the installation steps below. (When installing the toilet for the first time, a spare battery needs to be installed.)



Step 1. Cut off the power supply and find the power outage flushing wire interface behind the toilet.



Step 2. Connect the 16V spare battery to the toilet's connection cable and place the battery in a dry area behind the toilet.

Note: When there is a power outage, please install the battery of the device for flushing. Press and hold the knob on the side of the toilet for 3 seconds to flush.

Foam liquid replacement and installation



Step 1. Push the back cover of the toilet out to the back and pick up the back cover of the toilet.



Step 2. Remove the connecting tube of the foam bottle.



Step 3. Fill an empty bottle with tap water, and then put the effervescent tablets into the bottle to dissolve.

If you use up this bottle of foam solution, you can purchase a separate concentrated foam solution or take detergent to water to replace it.



Step 4: Connect the filled foam bottle and tighten it.



Step 5: After putting the foam bottle into the empty slot, reinstall the back cover of the toilet in its original position.

Product standard

Dimensions	68.5*39.5*48CM		
Rated voltage	Alternating voltage 110V±10%, 60HZ		
Rated power	Water inlet temperature: 59°F Outlet water temperature: 104°F Water discharge: 750ml/min Power: 1350W		
Cleaning	Water outlet	Hip cleaning	About 700 ml/min
		Female cleaning	About 700 ml/min
	Outlet water temperature		Normal temperature, and 93°F/99°F/104°F(4 levels)
	Water heating		Instant water heater
	Heater power		Water inlet temperature: 59°F Outlet water temperature: 104°F Water discharge: 750ml/min Power: 1350W
Seat heating	Seat temperature		Normal temperature, and 93°F/99°F/104°F(4 levels)
	Heater power		45W
Warm drying	Wind temperature		Normal temperature, and 113°F/122°F/131°F(4 levels)
Spray position			Adjustable fore and aft
Water temperature			41~104°F
Water pressure (with water tank)			There is no water pressure requirement.

For any questions or support, please email: [support-cs@hkfoam.com]

Due to different printing time of the materials, the product specifications may be slightly changed.
Please refer to the material object.