

ARMOIRE

ARMARIO

This instruction manual contains important information. Follow the consecutive order. Please read and keep for future reference.

Este Manual contiene información importante. Siga el orden consecutivo de las instrucciones.

Por favor léalo y guárdelo para consultas en el futuro.



Two or more people are required to assemble and/or move this unit.
Se requiere de dos o más personas para armar y mover este mueble.



Unpack and assemble this unit in an spacious area. Assemble the unit on top of the empty box to prevent scratches.
Desempaque y arme este mueble en un area espaciosa. Arme el mueble sobre su caja, para no rayarlo.



Protect furniture from water and moisture. This furniture must not be used outdoors.
Proteja el mueble del agua y de la humedad. No use este mueble al aire libre.



Do not expose it to heat.
No lo exponga al calor.



Do not hit or tap with a hammer, unless it is indicated.
No lo golpee ni lo martille.



Do not paint or use abrasive elements to clean this furniture.
No pinte ni use elementos abrasivos para limpiar este mueble.



Do not drag or climb on your furniture. If you need to move it, lift it.
No lo arrastre ni se suba al mueble. Si necesita moverlo, levántelo.



Certificado Nº sc 640-1



Thank you for purchasing this product. We trust that you will be completely satisfied with your product for years to come. This product is backed by a 5 year limited warranty and has been crafted with today's lifestyles in mind.

Le damos las gracias por adquirir este producto. Confiamos en que quede completamente satisfecho con su compra. Este producto tiene una garantía limitada de 5 años y ha sido creado atendiendo al estilo de vida de hoy día.

PARTS IDENTIFICATION / IDENTIFICACIÓN DE PARTES

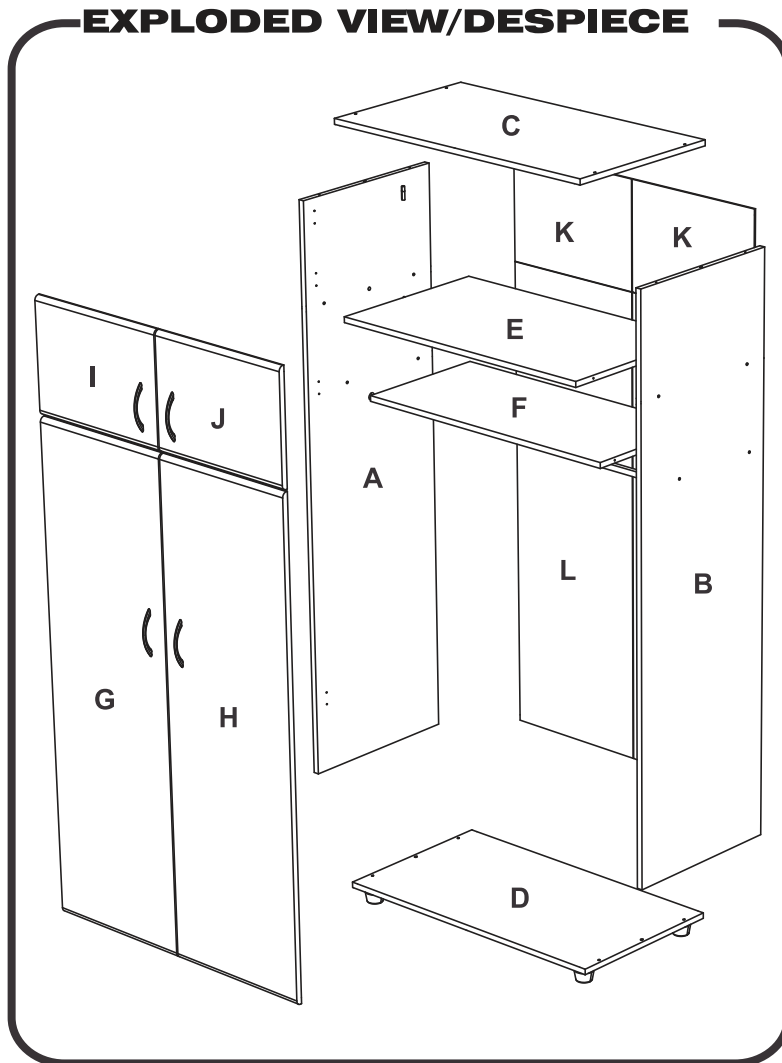

**PARTS LIST
TABLA DE PIEZAS**

PARTS PIEZA	QUANTITY CANTIDAD
A	1
B	1
C	1
D	1
E	1
F	1
G	1
H	1
I	1
J	1
K	2
L	2

QUANTITY CANTIDAD	FROM DESDE	TO HASTA
14	A	L

IDENTIFICACIÓN DE HERRAJES HARDWARE IDENTIFICATION

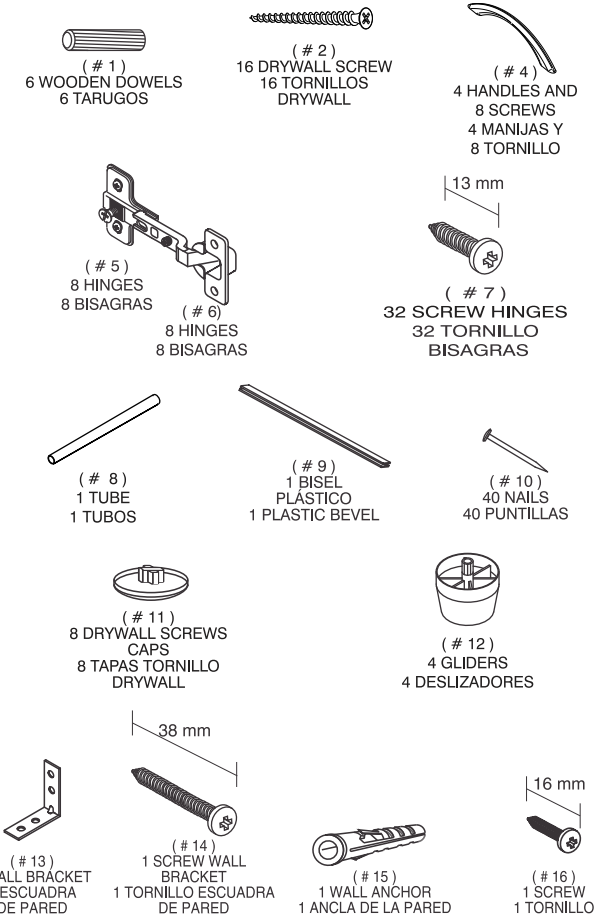

IMPORTANT: Before proceeding to assemble this unit, read the instructions and inspect carefully the parts and hardware thoroughly. If any part is missing, do not return to the store, please call toll free

IMPORTANTE: Antes de empezar a ensamblar este mueble, lea este instructivo y revise cuidadosamente las piezas y herrajes. En caso de que le haga falta alguna pieza, no lo devuelva a la tienda, favor llamar a la línea gratuita

ASSEMBLY STEPS / PASOS PARA ENSAMBLAR 1

PARTS SET UP / PREPARACIÓN DE PIEZAS

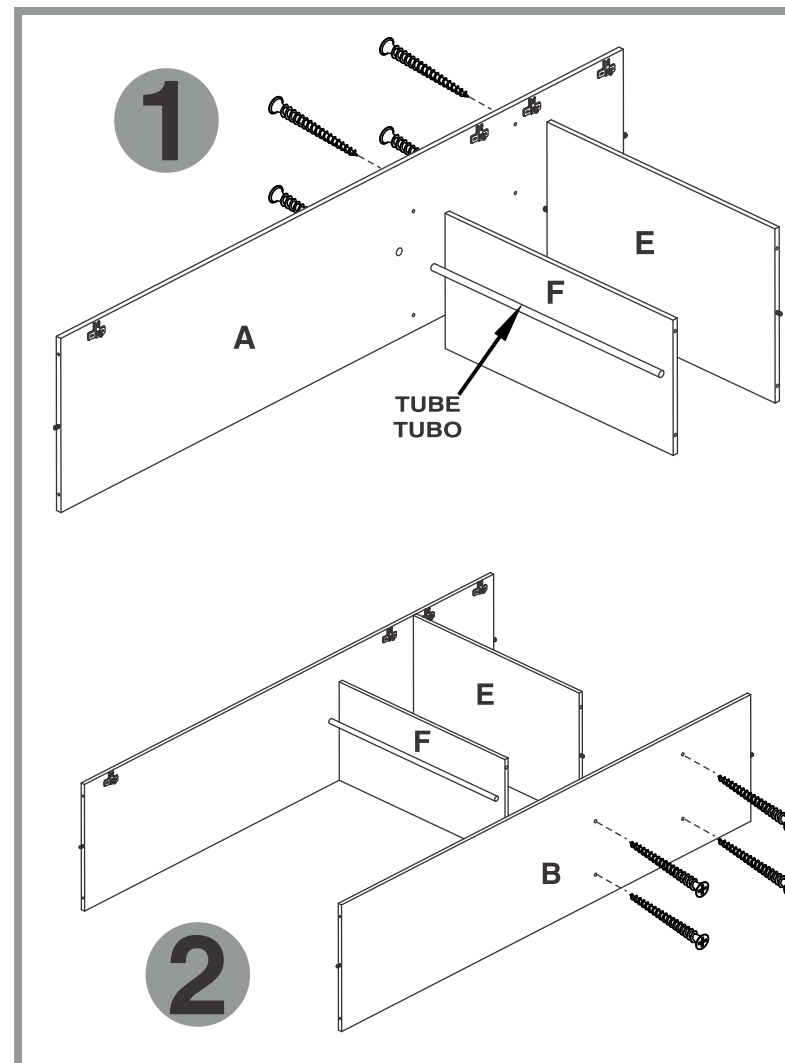
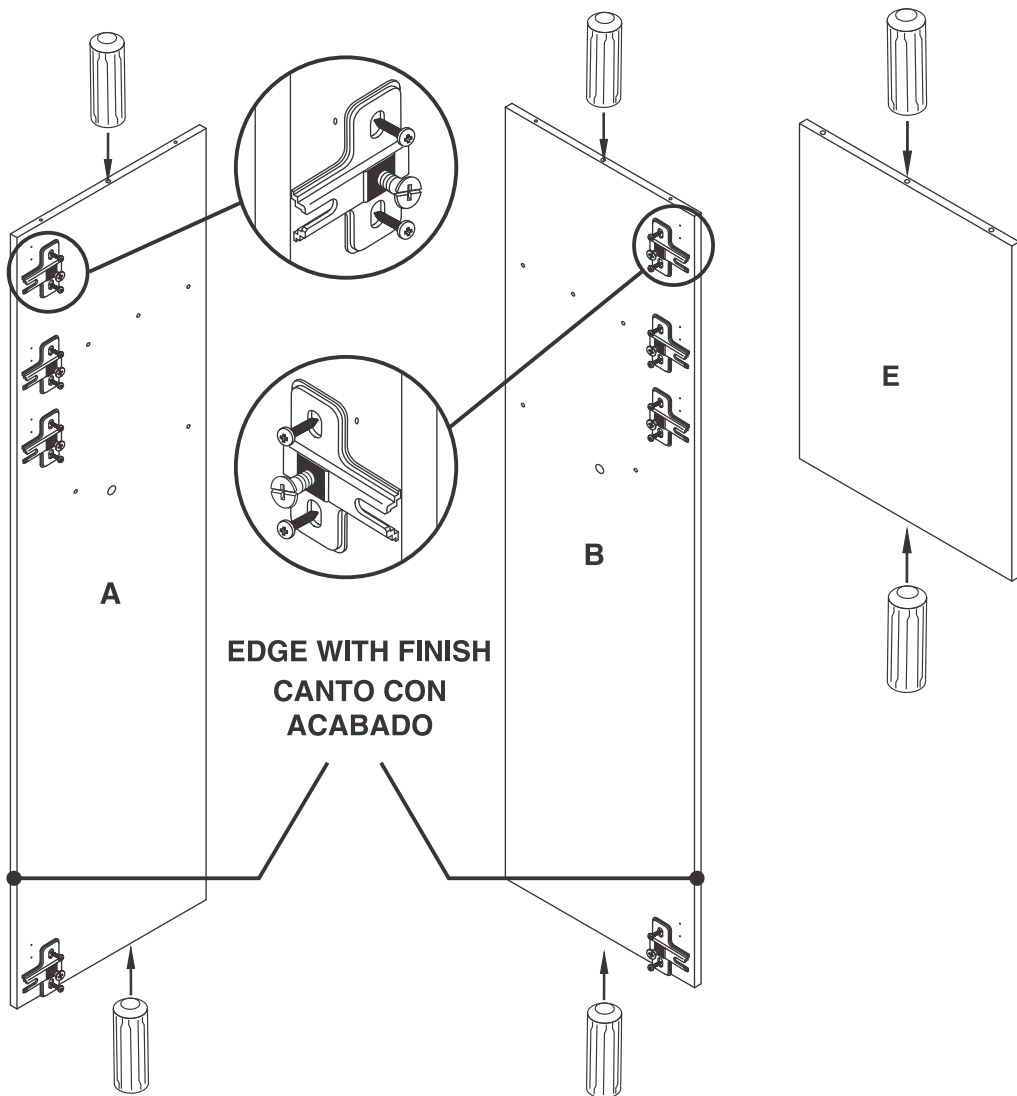

FOR THIS STEP, YOU WILL NEED:
EN ESTE PASO NECESITA:

TOOLS
HERRAMIENTAS

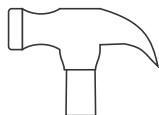

HAMMER/
MARTILLO

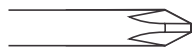

PHILLIPS SCREWDRIVER /
ATORNILLADOR DE ESTRELLA

HARDWARE
HERRAJES



(# 5)
HINGES
BISAGRAS

13 mm



(# 7)
SCREW HINGES
TORNILLO
BISAGRAS



(# 1)
WOODEN DOWELS
TARUGOS



(# 8)
TUBE
TUBOS

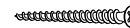

(# 2)
DRYWALL SCREW
TORNILLOS
DRYWALL

2 ASSEMBLY STEPS / PASOS PARA ENSAMBLAR

PARTS SET UP / PREPARACIÓN DE PIEZAS

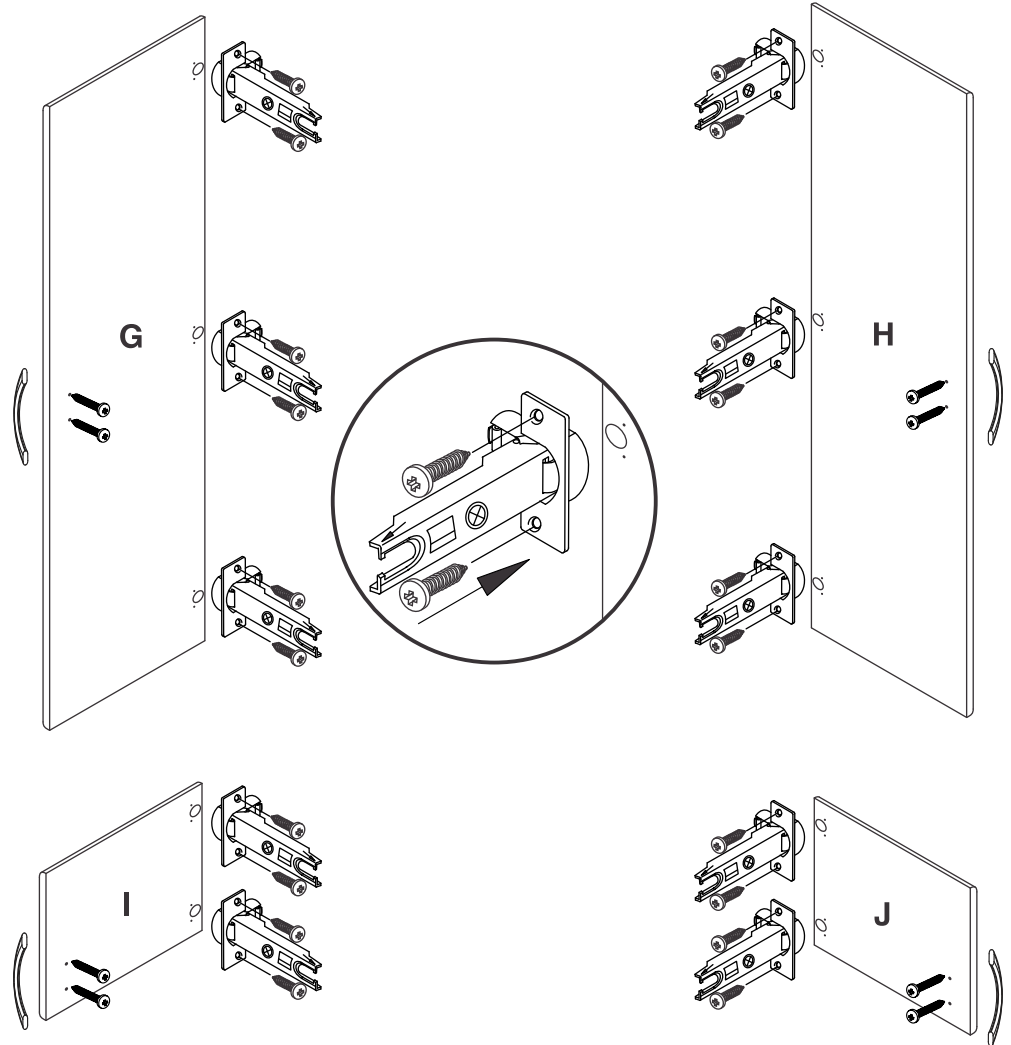
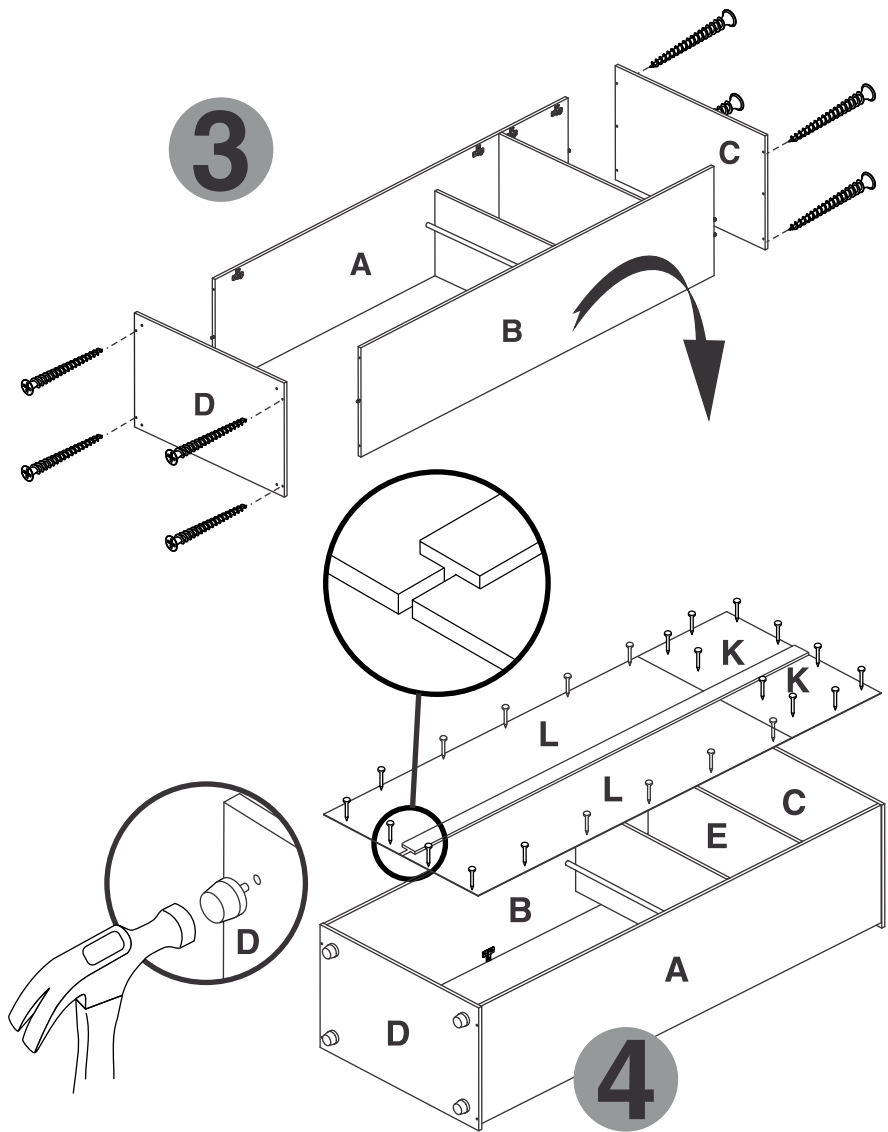

FOR THIS STEP, YOU WILL NEED:
EN ESTE PASO NECESITA:

TOOLS
HERRAMIENTAS

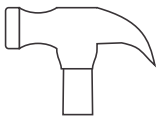

HAMMER/
MARTILLO

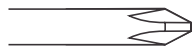

PHILLIPS SCREWDRIVER /
ATORNILLADOR DE ESTRELLA

HARDWARE
HERRAJES

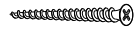

(# 2)
DRYWALL SCREW
TORNILLOS
DRYWALL



(# 9)
1 BEVEL
PLÁSTICO
1 PLÁSTICO BEVEL



(# 10)
40 NAILS
40 PUNTILLAS



(# 12)
4 GLIDERS
4 DESLIZADORES

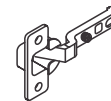

(# 5)
HINGES
BISAGRAS



(# 7)
SCREW HINGES
TORNILLO
BISAGRAS



(# 4)
HANDLES AND
SCREWS
MANIJAS Y
TORNILLO

ASSEMBLY STEPS / PASOS PARA ENSAMBLAR 3

5

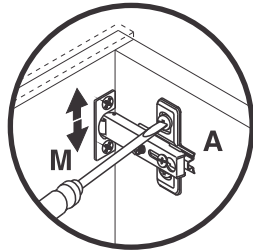

**HEIGHT ADJUSTMENT
AJUSTE DE ALTURA**

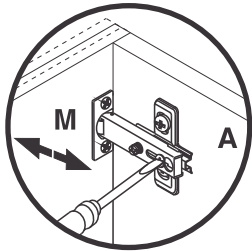

**DEPTH ADJUSTMENT
AJUSTE DE PROFUNDIDAD**

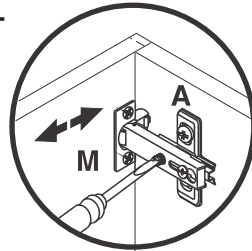

**LATERAL ADJUSTMENT
AJUSTE LATERAL**

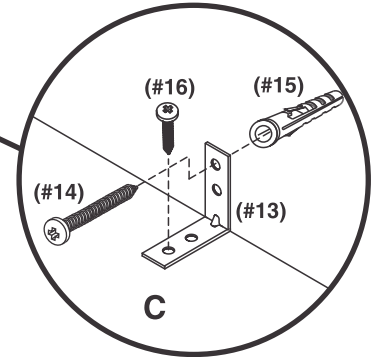
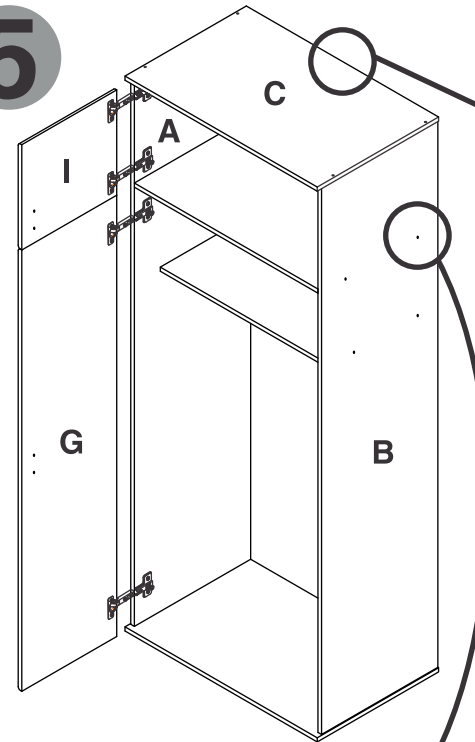

Drill a 3/16" diameter hole (5mm) in the wallboard.
Tap the wall anchor (#15) into the hole until it is flush.
Fasten the wall bracket (#13) to the wall anchor (#15) with the screw (#14).

Taladre un agujero de 3/16" de diámetro (5mm) en la pared. Golpee la ancla de pared (#15) en el agujero hasta que sea parejo. Abroche la escuadra de pared (#13) a la ancla de la pared (#15) con el tornillo (#14).

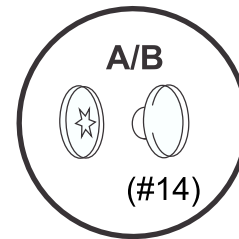

CONGRATULATIONS! this way you finished assembling your furniture.

¡FELICITACIONES! de esta manera usted termina de armar su mueble.

To level the Door Parts "I", "J", "G", "H", follow these steps:
HEIGHT ADJUSTMENT: Allows Parts "I", "J", "G", "H", to be raised or lowered to level it with parts "C". Loosen the Hinge screw, as shown in the detail, to adjust the door to the desired position, and retighten the Hinge screws.
DEPTH ADJUSTMENT: Allows Parts "I", "J", "G", "H" to be moved forward or backward by loosening the Hinge screw as shown in the detail.
LATERAL ADJUSTMENT: Allows Parts "I", "J", "G", "H" to be moved right or left, leveling it with parts "A", "B" by loosening or tightening the Hinge screw as shown in the detail.

Para nivelar las puertas partes I, J, G, H, tenga en cuenta las siguientes indicaciones: **AJUSTE DE ALTURA:** Le permite subir o bajar las partes I, J, G, H, cuadrándola al nivel de la parte C, aflojando el tornillo de la bisagra, como lo muestra el detalle. Cuando este en el lugar indicado, asegure los tornillos bisagra. **AJUSTE DE PROFUNDIDAD:** Le permite llevar las partes I, J, G, H, hacia adentro o hacia afuera, aflojando el tornillo de la bisagra, como lo muestra el detalle. **AJUSTE LATERAL:** Le permite llevar las partes I, J, G, H, hacia la derecha o la izquierda, nivelándola con la parte A, B aflojando o apretando el tornillo de la bisagra, como lo muestra el detalle.

FOR THIS STEP, YOU WILL NEED:
EN ESTE PASO NECESITA:

TOOLS
HERRAMIENTAS

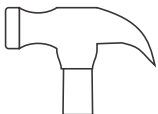

HAMMER/
MARTILLO

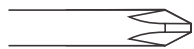

PHILLIPS SCREWDRIVER /
ATORNILLADOR DE ESTRELLA

HARDWARE
HERRAJES



(# 11)
DRYWALL SCREWS
CAPS
TAPAS TORNILLO
DRYWALL



(# 13)
WALL BRACKET
ESCUADRA
DE PARED

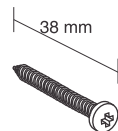

(# 14)
SCREW WALL
BRACKET
TORNILLO ESCUADRA
DE PARED



(# 15)
WALL ANCHOR
ANCLA DE LA PARED



(# 16)
SCREW
TORNILLO