







ASSEMBLY INSTRUCTION FOR QUEEN BED

HARDWARE LIST

A		Bolt	8mm x 65mm	8
B		Halfmoon washer	8*15*30 mm	8
C		Allen Wrench	5mm	1
D		Screw	4mm x 40mm	2
E		Screw	4mm x 30mm	6
F		Screwdrivers (Not included)		1
G		Leg Support		2

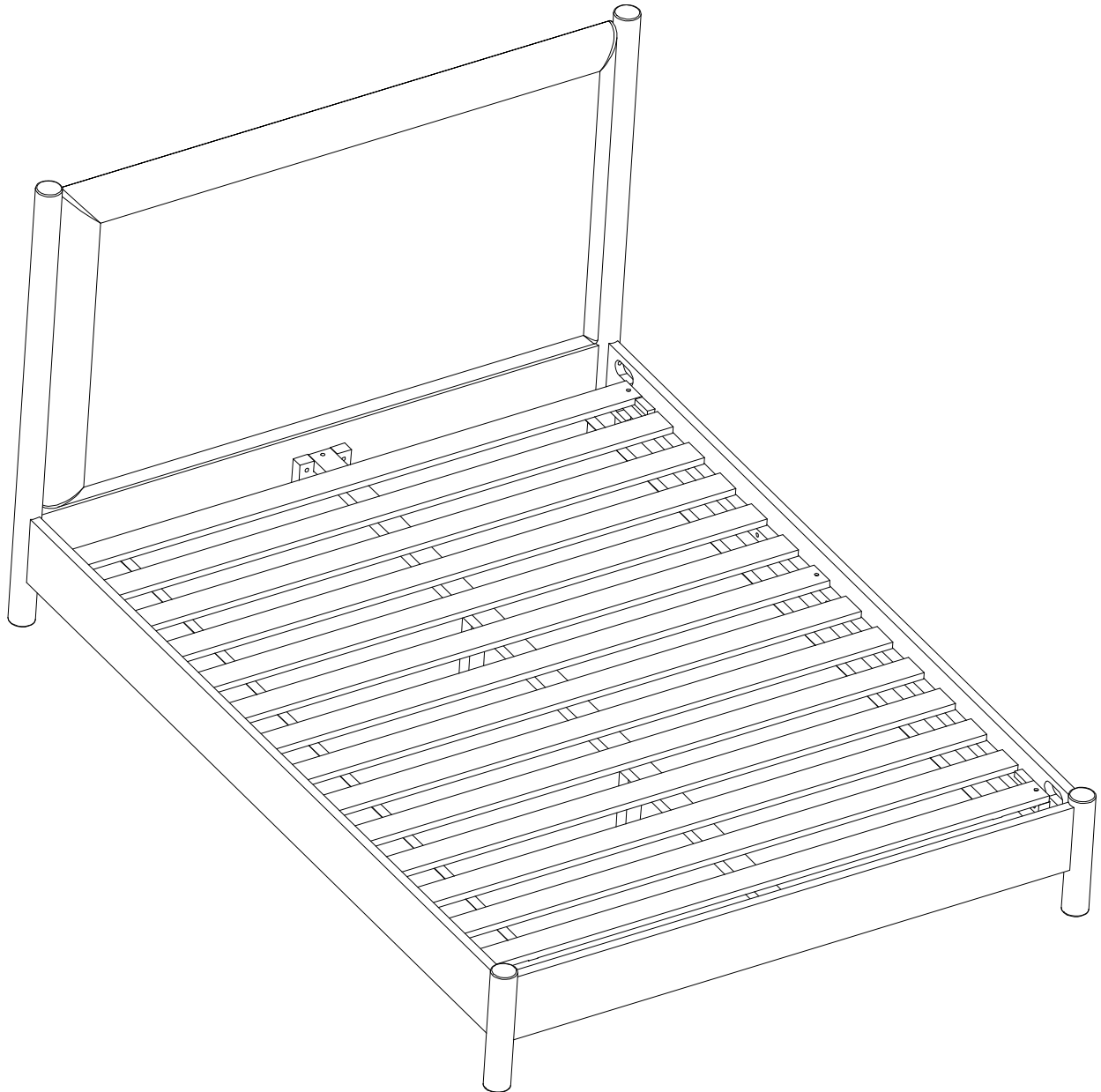

COMPONENTS

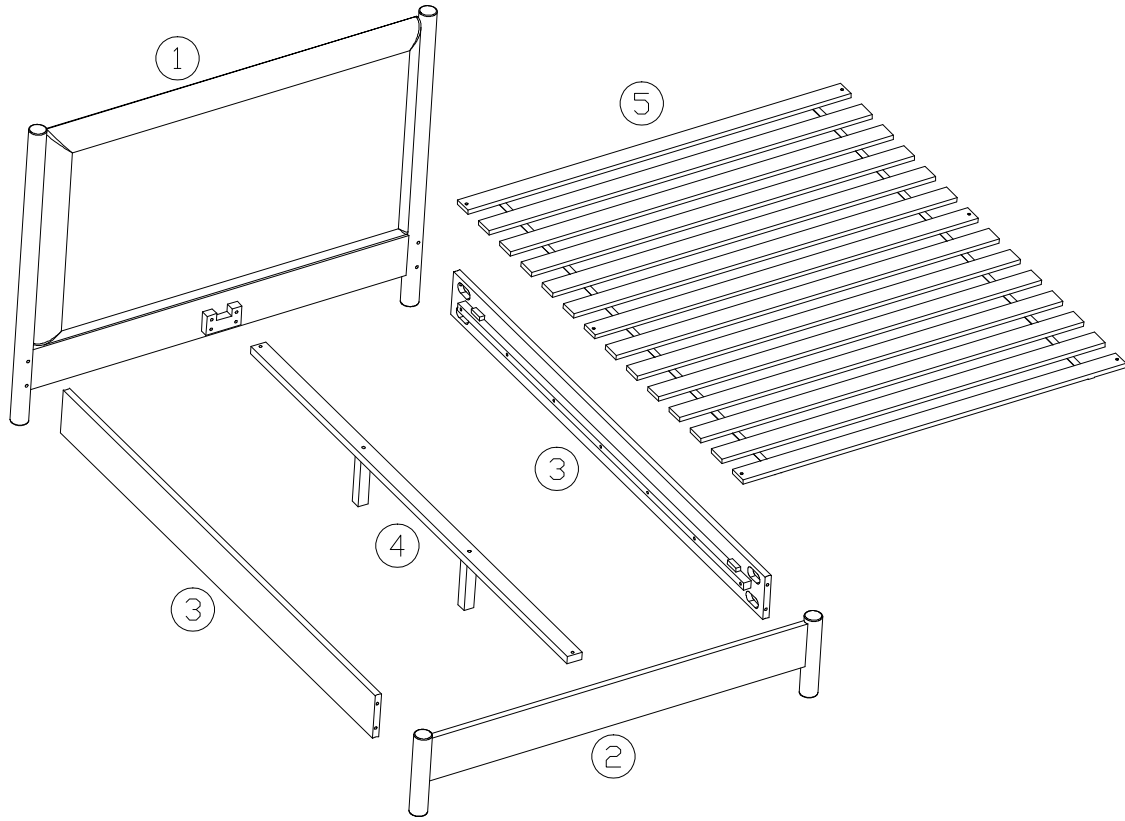

1

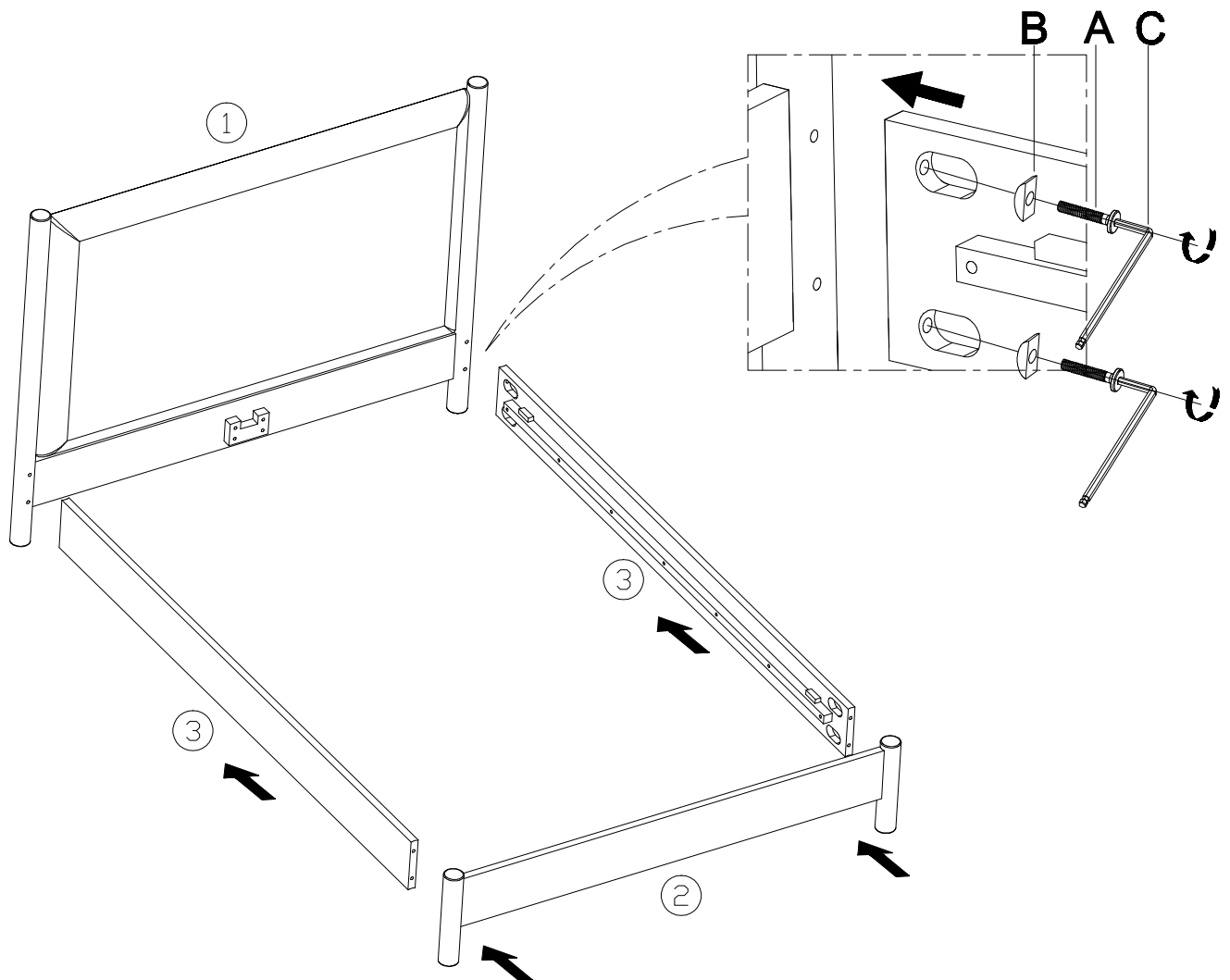

2

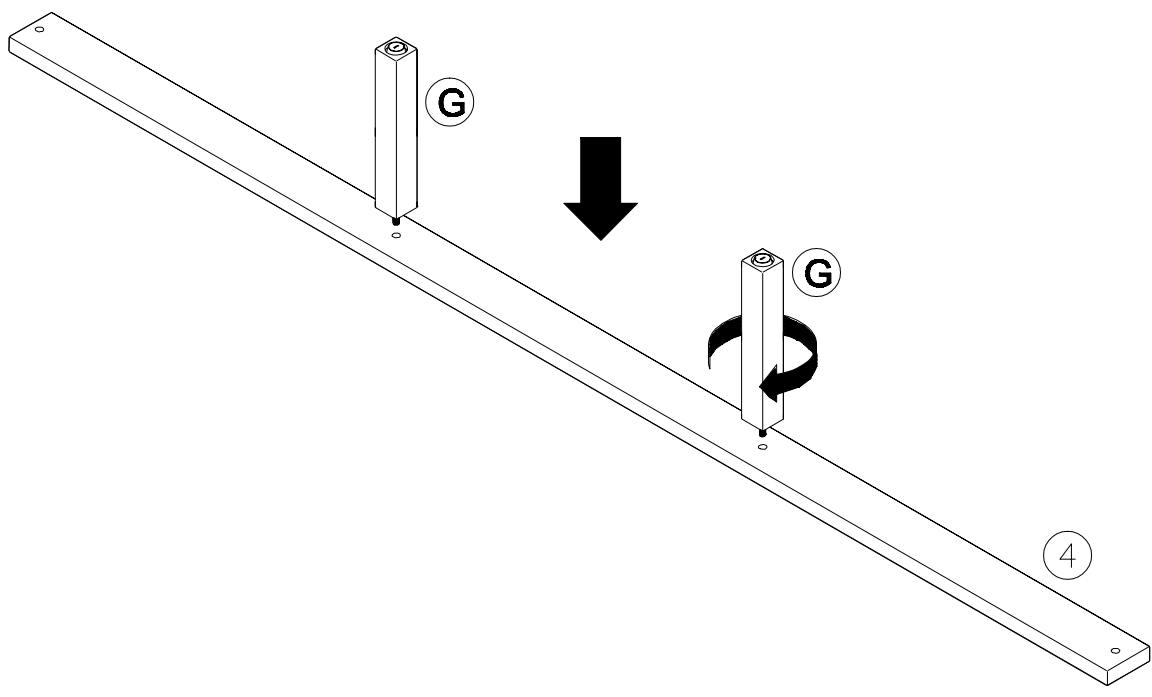

3

