

## WARNING

- \* Switch off the main electrical supply from the main fuse box / circuit breaker before installation.
- \* Inspect item carefully before attempting to install.
- \* If there is any damages or obvious defects, do not install.
- \* Item may not be returned once it has been installed.









## CARE AND MAINTENANCE

- \* To clean the outside of the fixture, use a dry or slightly dampened clean cloth (use clean water, never a solvent) to wipe the surface of the fixture.
- \* To clean the inside of the fixture, first disconnect power to the fixture by turning off the circuit breaker or by removing the fuse at the fuse box. Next, use a dry or slightly dampened clean cloth (use clean water, never a solvent) to wipe the interior surface of the fixture.
- \* Do not use any cleaners with chemical, solvents or harsh abrasives. Use only a dry soft cloth to dust or wipe carefully.

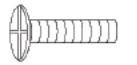
## NOTICE& IMPORTANT SAFETY INSTRUCTIONS

- \*\* WE RECOMMEND INSTALLATION OF THIS LIGHTING FIXTURE BE DONE BY A LICENSED ELECTRICIAN \*\*
- \* Please make sure that you have all parts indicated before you begin assembly of this item
- \* This item should be assembled on a soft surface to prevent scratching the finish during assembly
- \* To reduce the risk of fire, electrical shock or injury to persons or property, please follow the guideline below for safe use and installation

### Part List and Hardware List

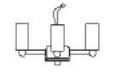
PIECE	DESCRIPTION	PICTURE	QUANTITY	PIECE	DESCRIPTION	PICTURE	QUANTITY
A	Wire Nut		3X	F	Canopy Nut		2X
B	Mounting Screw		2X	G	Stem		2X
C	Mounting Plate		1X	H	Glass		1X
D	Bulb		4X	I	Iron Coil		1X
E	Canopy		1X	J	Socket Assembly		1X

Product Dimensions: 13"L X13"W X 25.25"H

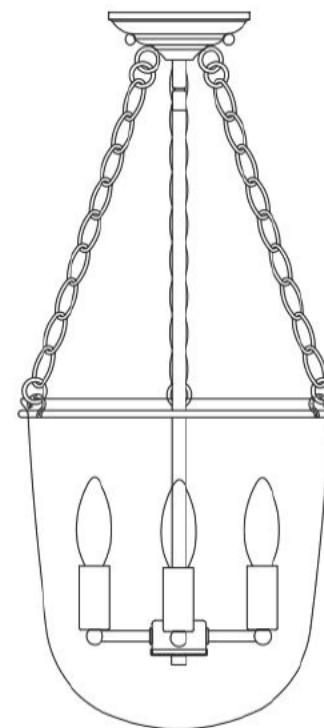

## PREPARATION

- \* Before beginning assembly of product, make sure all parts are present. Compare parts with package contents list and hardware contents list.
- \* If any part is missing or damaged, do not attempt to assemble the product.
- \* Estimated Assembly Time: 20 minutes.
- \* Tools Required for Assembly (not included): Screwdriver, Junction box

**NOTE: PLEASE USE TYPE "B" BULB MAX 40-WATT OR LED BULB MAX 9-WATT, THERE ARE 4\*LED 4-WATT BULBS IN THE BOX**

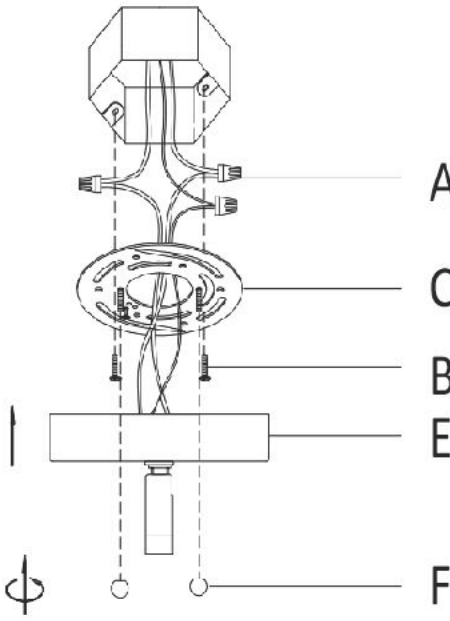
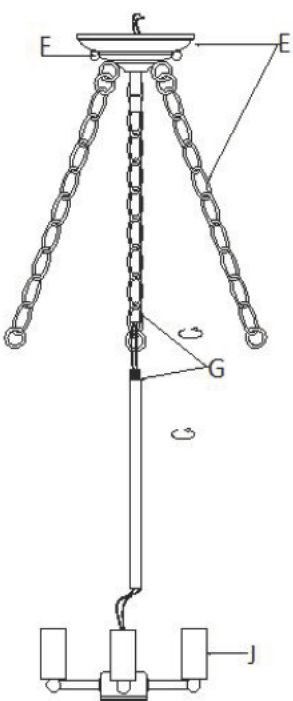
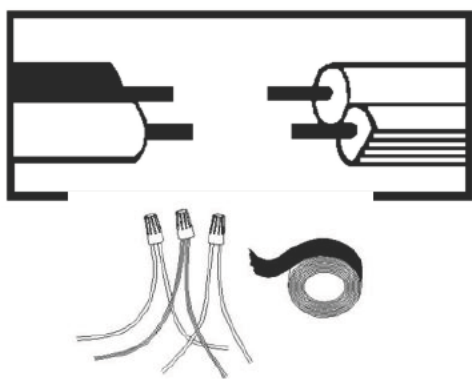
 <p><b>Step 1:</b> Unpack all parts from cartons carefully. Separate the Mounting Plate(C) from the Canopy(E) by turning the Canopy Nut (F) counter-clockwise. Install the Mounting Plate(C) to the junction box with Mounting Screw (B).</p>	 <p><b>Step 2:</b> Pass the wires from the Socket Assembly (J) to the Stem (G) and top cover (E). Rotate each part clockwise until tight.</p>	 <p><b>Step 3: Wire connection</b> Connect fixture neutral wire (ribbed) to the outlet box neutral wire (usually white) using a wire nut. Connect fixture hot wire (smooth with markings) to the outlet box hot wire (usually black) using a wire nut. <b>CAUTION:</b> Do not reverse the hot and neutral connections <b>Grounding Instructions:</b> Wrap ground wire from outlet box around green ground screw(B) on mounting bracket, no less than 2" from wire end. Tighten ground screw. If fixture is supplied with a ground wire, connect to outlet ground wire with a wire Nut.</p>
---	--	---

## PREPARATION

- \* Before beginning assembly of product, make sure all parts are present. Compare parts with package contents list and hardware contents list.
- \* If any part is missing or damaged, do not attempt to assemble the product.
- \* Estimated Assembly Time: 20 minutes.
- \* Tools Required for Assembly (not included): Screwdriver, Junction box

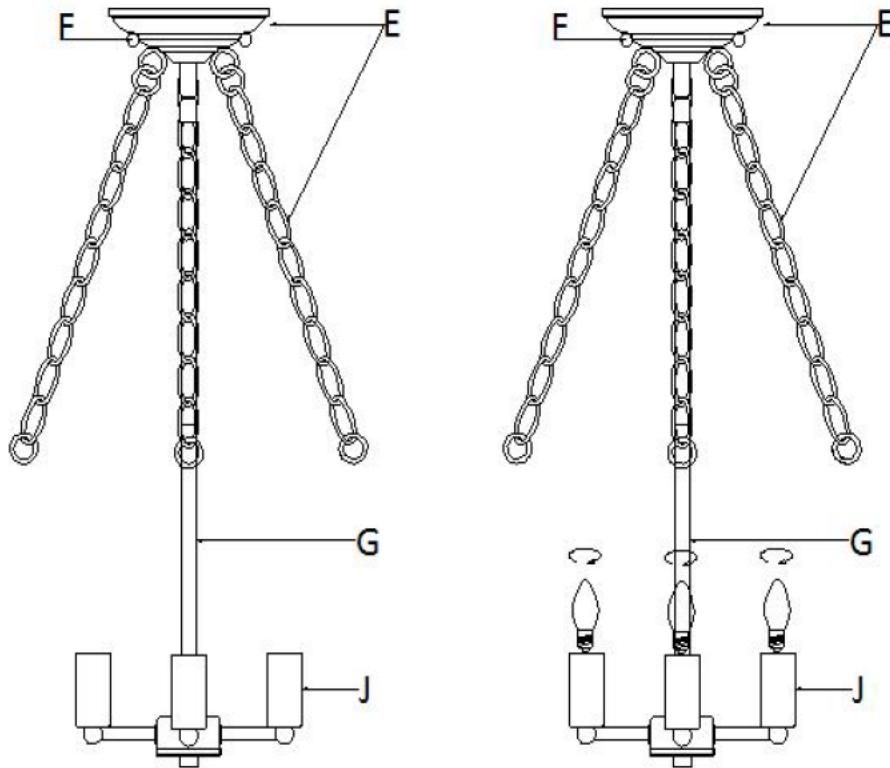

**Step 4:** As shown in Step 1, connect wires with Wire Nut (A), install the canopy (E) on the junction box, and rotate the canopy nut (F) clockwise to secure it. Insert the bulb (D) into the socket (J).

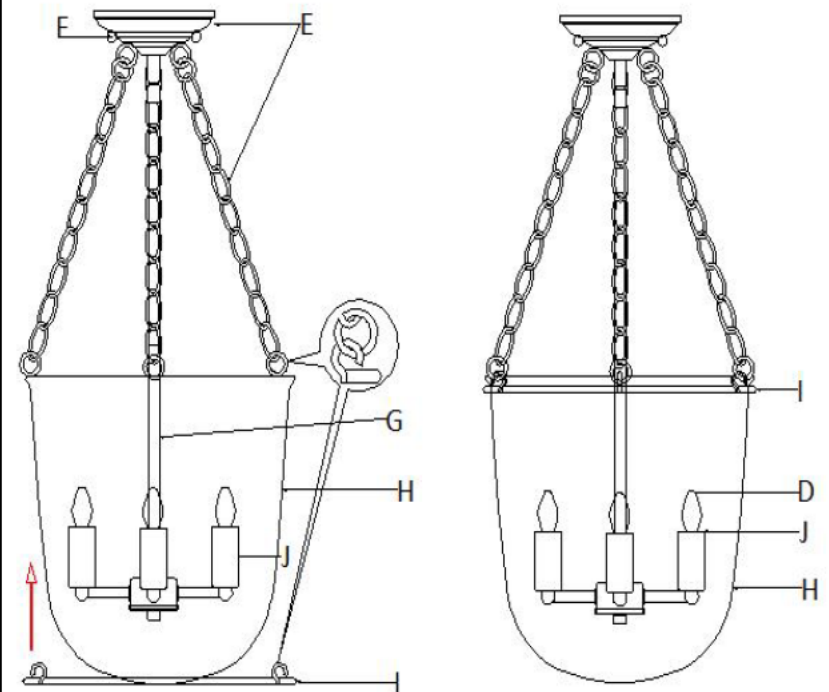

**Step 5:** Insert the iron ring (I) upward into the glass (H). Then hook the three hooks of the iron ring (I) into the three chain rings of the Canopy (E).