

HEADBOARD

affurnishings.com

ASSEMBLY INSTRUCTIONS

Before assembling your headboard, please read through these instructions carefully and familiarize yourself with the different parts.

ATTENTION! If you receive a damaged or defective item, please contact affurnishings.



PARTS LIST

- 1 HEADBOARD PANEL 1 PC
- 2 LEFT LEG 1 PC
- 3 RIGHT LEG 1 PC
- 4 PILLOW STOP 1 PC

Instructions apply for bed sizes
QUEEN > KING

HARDWARE

- A JCB M6 X 110mm (4 3/8") - 4 pcs
Spare - 1 pc
- B Barrel nut - 4 pcs
Spare - 1 pc
- F Allen wrench - 1pc
Spare - 1pc

HARDWARE FOR METAL BED FRAME

- C JCB M6 X 25mm (1") - 4 pcs
Spare - 1 pc
- D Flat washer - 4 pcs
Spare - 1 pc
- E Split washer - 4 pcs
Spare - 1 pc

NOTE: WE INCLUDE SPARE HARDWARE IN CASE DAMAGE OCCURS DURING ASSEMBLY.

Step 1

Attach the legs (2) and (3) to headboard panel (1) and pillow stop (4) using JCB (A) and barrel nut (B). Tighten with the Allen wrench (F).

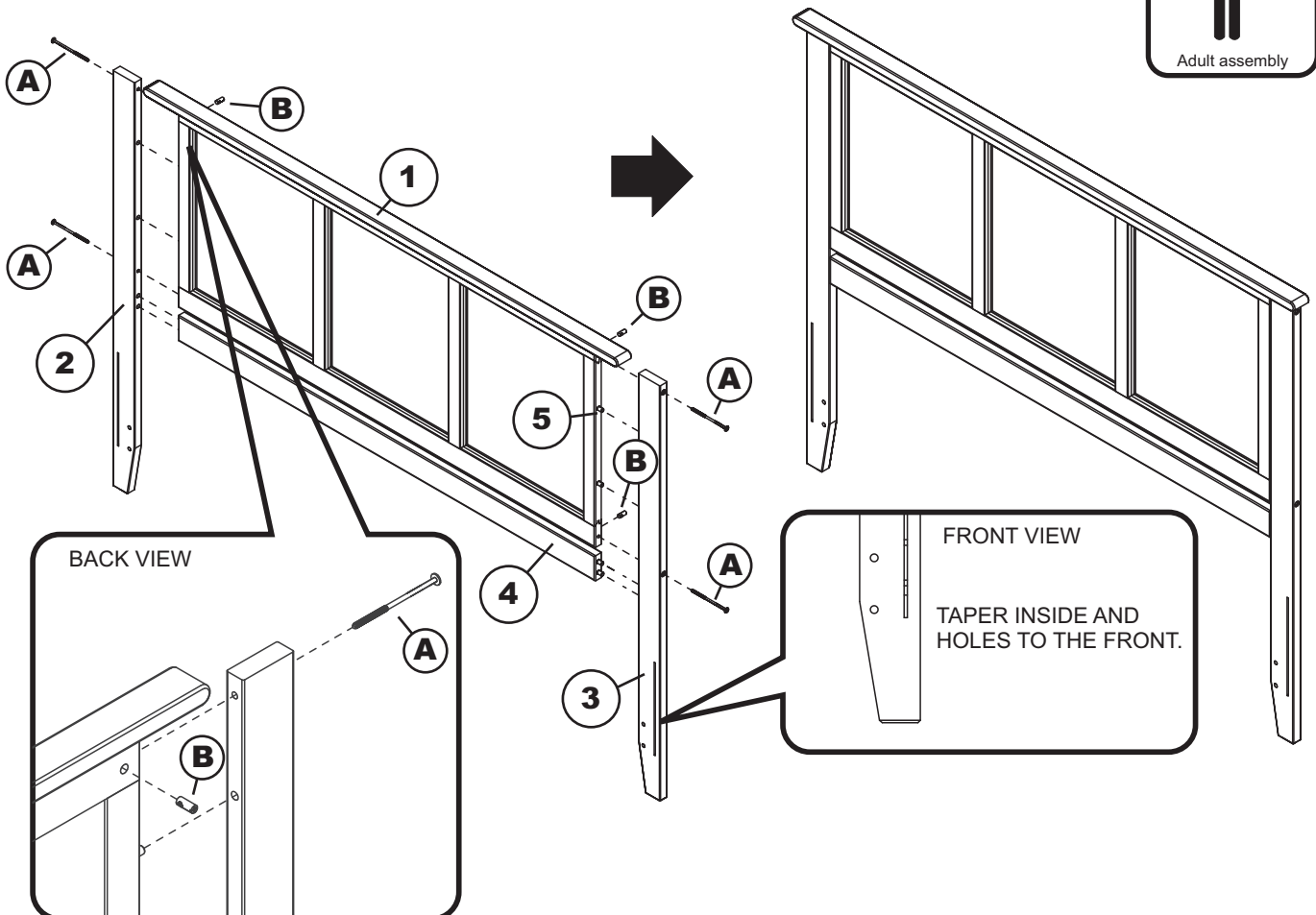

If you purchased a wood headboard to attach to metal bed frame, please refer to page 2.

ATTACHING HEADBOARD TO METAL BED FRAME

affurnishings.com

ASSEMBLY INSTRUCTIONS

Before assembling your bed, please read through these instructions carefully and familiarize yourself with the different parts.

Instructions apply for bed sizes
Queen > King



Adult assembly

Metal bed frames are sold separately from wood headboards. The hardware shown on this page is supplied with your wood headboard for attaching the bed frame to the headboard. The metal bed frame is supplied with its own assembly instructions and hardware.

Step 1

Attach the headboard assembly to the metal frame using JCB (C), flat washer (D), and split washer (E) then tighten with Allen wrench (F), as shown below.

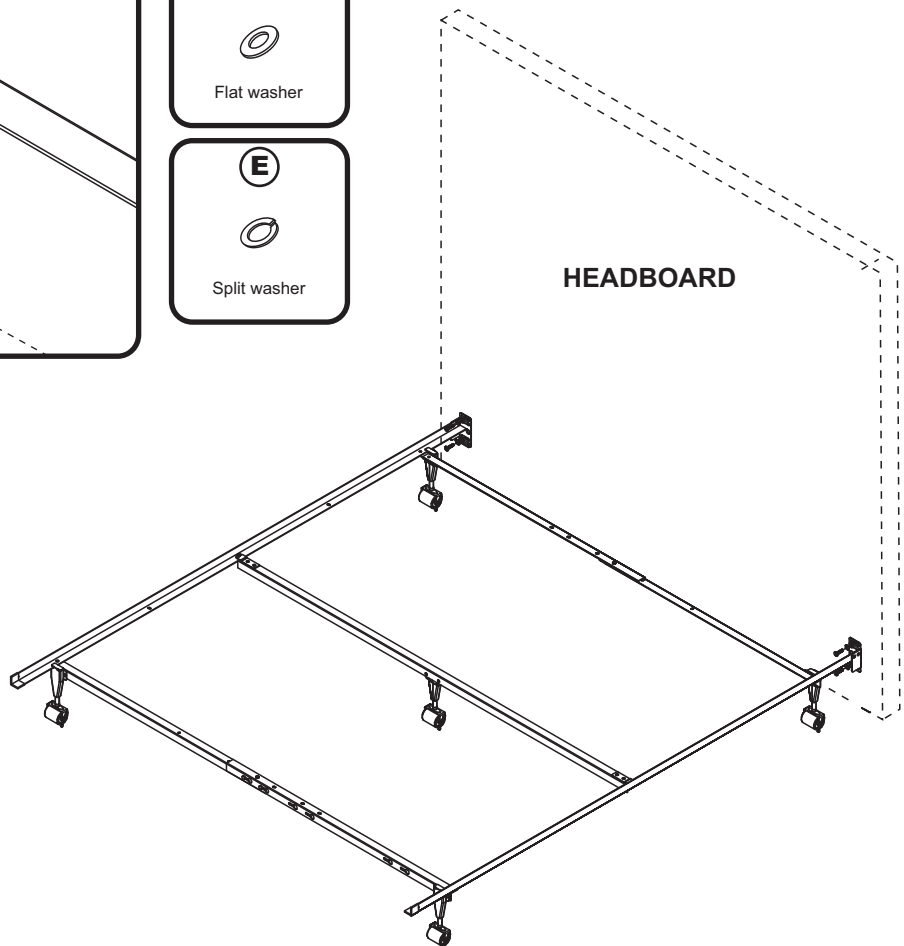
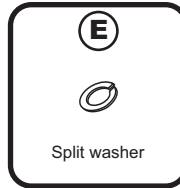
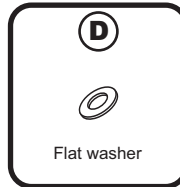
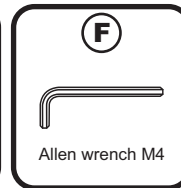
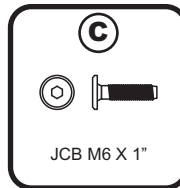
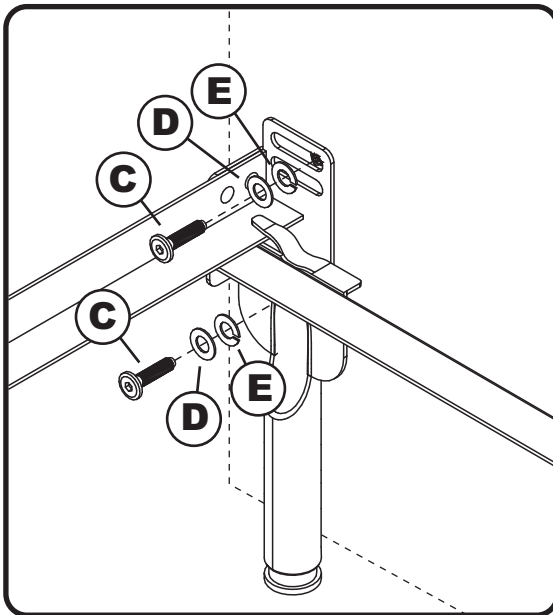

Congratulations!

Your bed is now ready for use.

To ensure lasting safety, we recommend that you periodically check that all screws are tight and all parts are secure.