

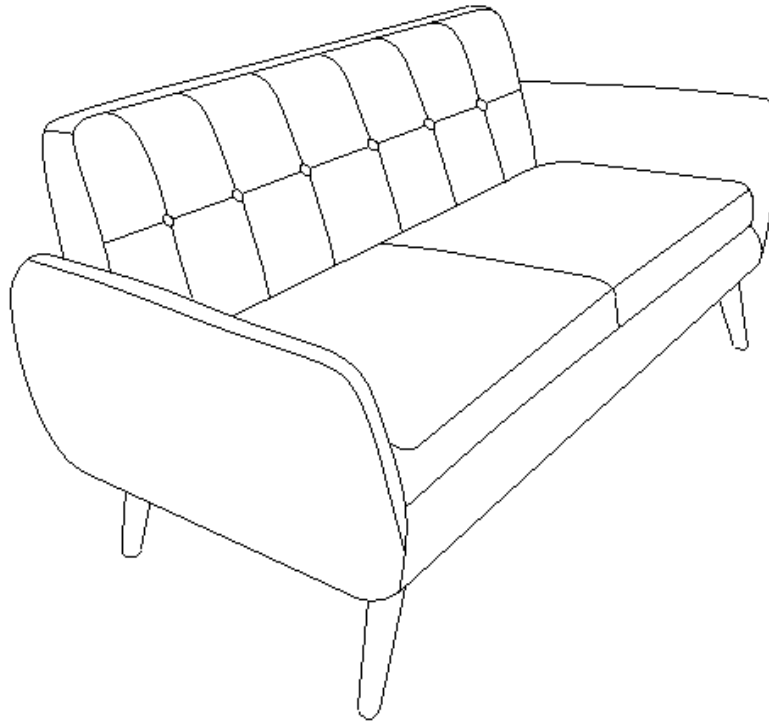

Assembly Instructions

Caution : You must read this before you proceed

Sofa

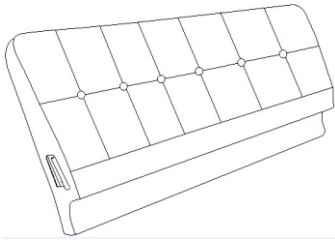

Parts List

Label	Picture	Description	QTY (pc)
A		Backrest	1
B		Wooden Leg	4

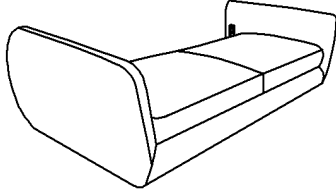
C		Base of Sofa	1
---	---	--------------	---

Hardwares List



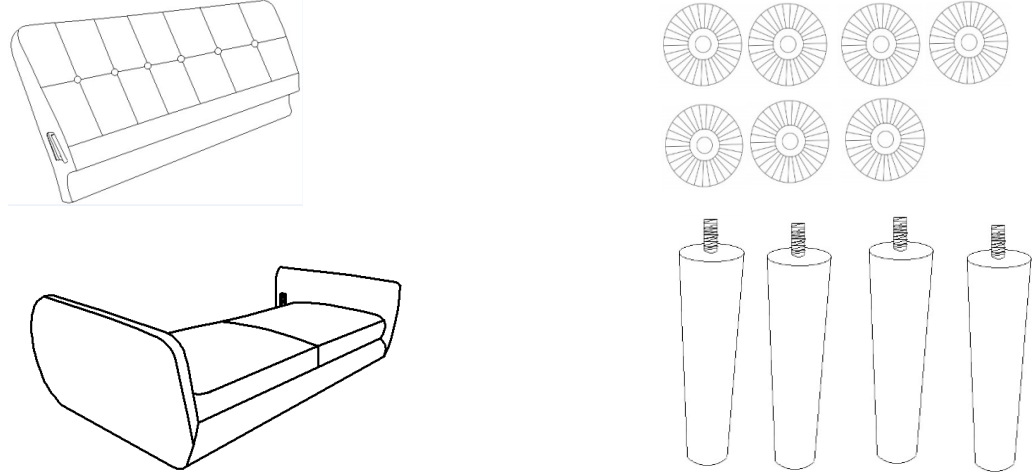

Label	Picture	Description	QTY (pc)
①		Gasket	7

Assembly Preparation

Before Beginning Assembly:



The diagram illustrates the preparation for assembling the sofa backrest. It shows a line drawing of the sofa backrest with seven gaskets (represented by circles with radial lines) being placed along its top edge. Below the backrest is a line drawing of the sofa base. To the right, four legs (represented by vertical cylinders) are shown, each with a gasket being placed on its top surface.

- 
• Read instructions, cover to cover-
- 
• Have 2 adults on hand for assembly-
- 
• Do not assemble on flooring or carpet-
- 
• Assemble on a clean non-marring surface (packing foam)-
- 
• Save all packaging until finished-

Assembly Steps

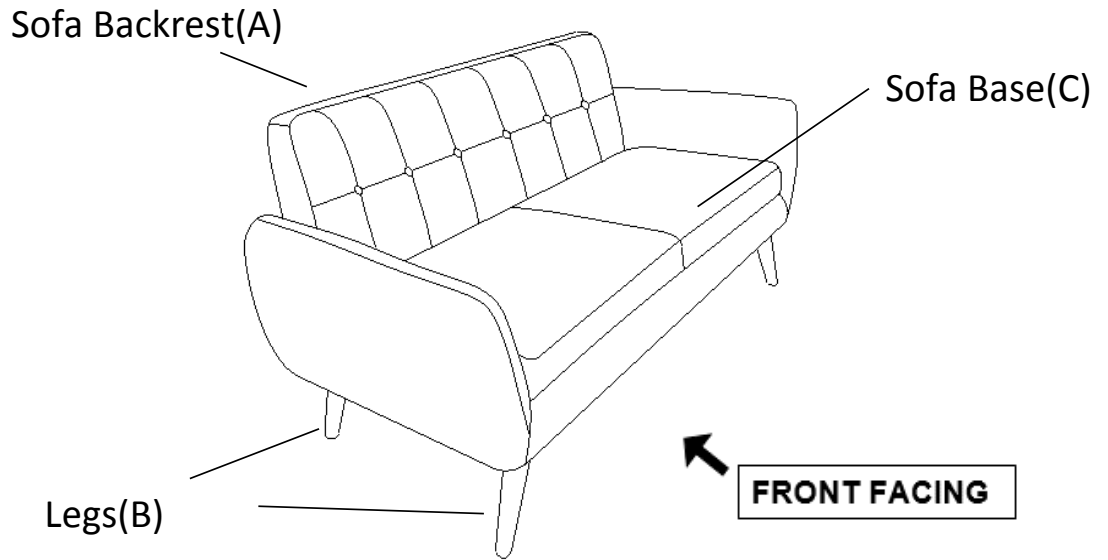

This product has multiple parts and may require up to some 30 minutes to assemble. To give you an overview of the product parts, the above picture is to help you put the various parts into perspective. Please read through the instructions below to familiarise yourself with the parts and steps before assembly.

Step 1

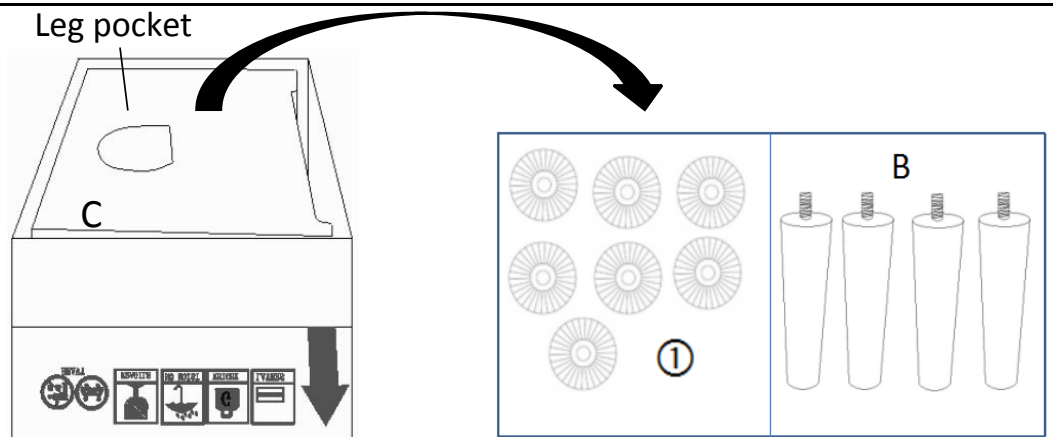

Take out the Legs(B) and Gaskets(①) from the Leg pocket.

Step 2

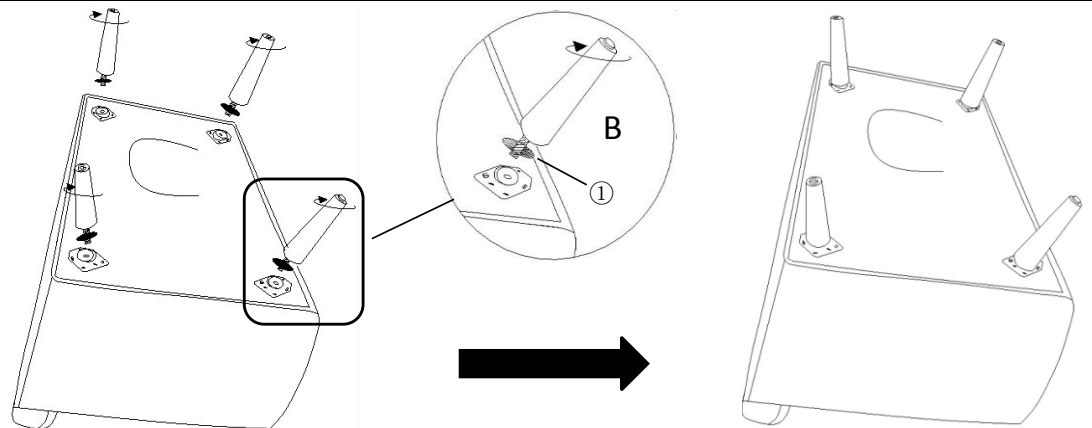

Install the Leg(B) at the bottom of the Sofa by placing one Gasket(①) on the threaded stem. Then insert threaded stem into the mounting position at the corner of the Loveseat.

Tighten by turning the Leg clockwise, Do not over tighten.

Repeat the same process to install the remaining three Legs.

Note: The use of Gaskets are OPTIONAL and are especially useful to help alleviate slight wobbleness. Some Legs may need more than one gasket whilst some Legs may not need any.

Step 3

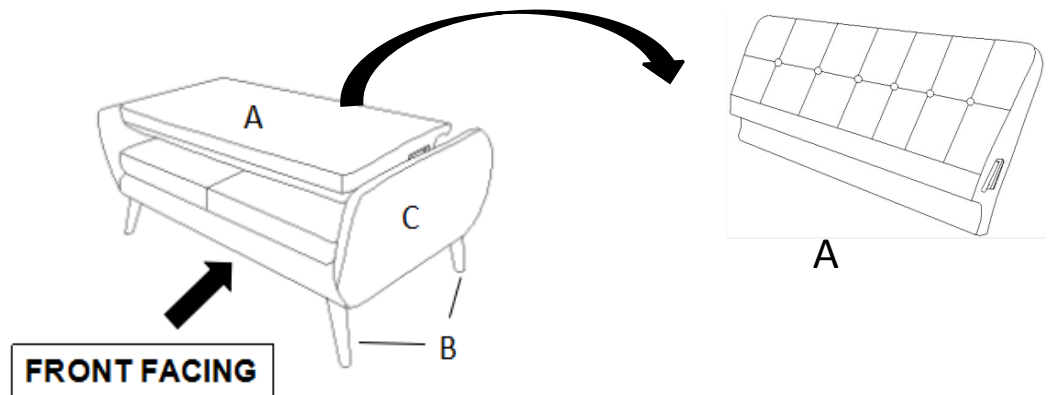

Take down the Backrest(A) from the top side of Base (C) and hold the Backrest(A) for next Step.

Caution: Assistance from your adult partner is needed in this assembly process.

Step 4

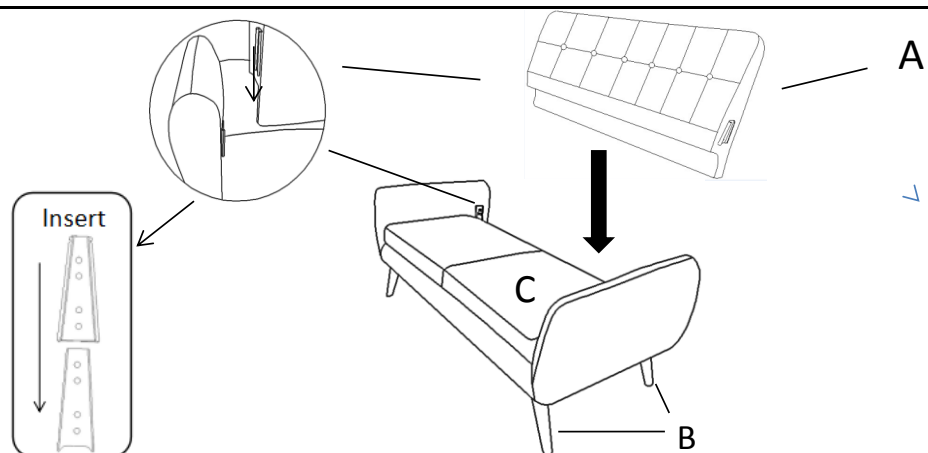

Insert the Backrest(A) into the Sofa Base(C) at the slots pressing gently but firmly downwards until they click into place.

Caution: Assistance from your adult partner is needed in this assembly process.

Step 5

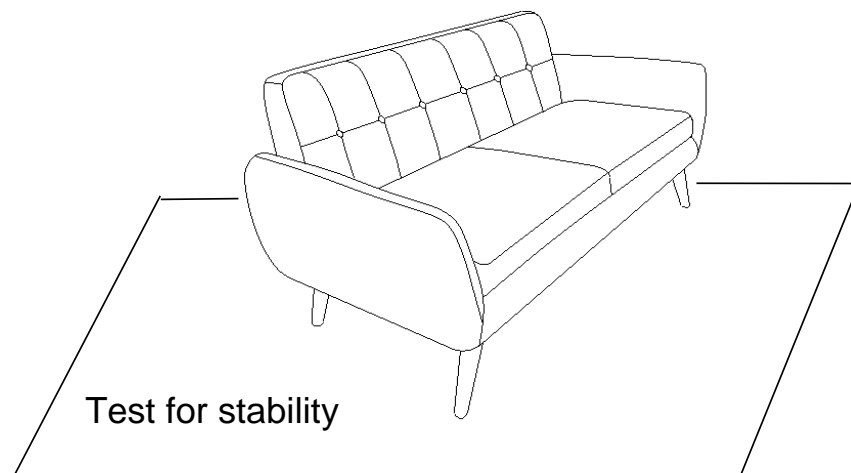











Position Sofa right side up and test for stability.

Your Sofa is ready for use.

This Sofa can only be used on a flat, level surface.

Care & Maintenance

-  ● Do not put hot items directly on furniture surface
 -  ● Do not clean furniture with harsh cleansers or polish.
 -  ● Do not place furniture under direct sunlight.
 -  ● Do not place furniture near heating or cooling vents.
 -  ● Do not write on furniture without a padded barrier to protect the surface.
 -  ● Do not place furniture outside . For indoor use only .
 -  ● Not for commercial use. For residential use only .
 -  ● Stains may be removed with mild soap solution and damp cloth.
 -  ● Children should not climb or jump on the furniture.
-
-  ● Dust and pick-up spills using a clean, non-colored, lint-free cloth .

Questions & Answers about Proposition 65

• What is Proposition 65?

Proposition 65 requires businesses to provide warnings to Californians about significant exposures to chemicals that cause cancer, birth defects or other reproductive harm. These chemicals can be in the products that Californians purchase, in their homes or workplaces, or that are released into the environment. By requiring that this information be provided, Proposition 65 enables Californians to make informed decisions about their exposures to these chemicals.

Proposition 65 also prohibits California businesses from knowingly discharging significant amounts of listed chemicals into sources of drinking water.

Proposition 65 requires California to publish a list of chemicals known to cause cancer, birth defects or other reproductive harm. This list, which must be updated at least once a year, has grown to include approximately 900 chemicals since it was first published in 1987.

• What types of chemicals are on the Proposition 65 list?

The list contains a wide range of naturally occurring and synthetic chemicals that include additives or ingredients in pesticides, common household products, food, drugs, dyes, or solvents. Listed chemicals may also be used in manufacturing and construction, or they may be byproducts of chemical processes, such as motor vehicle

• What does a warning mean?

If a warning is placed on a product label or posted or distributed at a workplace, a business, or in rental housing, the business issuing the warning is aware or believes that it is exposing individuals to one or more listed chemicals.

By law, a warning must be given for listed chemicals unless the exposure is low enough to pose no significant risk of cancer or is significantly below levels observed to cause birth defects or other reproductive harm.

• Where can I get more information on Proposition 65?

If you have specific questions on the administration or implementation of Proposition 65, you can contact OEHHA's Proposition 65 program at P65.Questions@oehha.ca.gov, or by phone at (916) 445-6900.