

# INSTRUCTIONS MANUAL



## PATIO WICKER SWIVEL ROCKING CHAIR

---

**Loosely assemble before tightening.**

IF YOU PURCHASED THE SWIVEL ROCKING CHAIR ONLINE AND  
HAVE ANY QUESTIONS OR CONCERNS  
PLEASE CONTACT US VIA EMAIL, TEXT, OR PHONE

---

# Warning:

## 1. Very important!

After receiving the product, please check if all parts are intact.

Do not open the vacuum-sealed packaging of the mat immediately.

Only proceed with opening the packaging if you are satisfied with the product.

2. When unpacking the box, please use tools carefully to avoid scratching the mat.

**Note: Since the mat is vacuum-packed, if you are not satisfied with the product after opening, it may affect the after-sales process.**

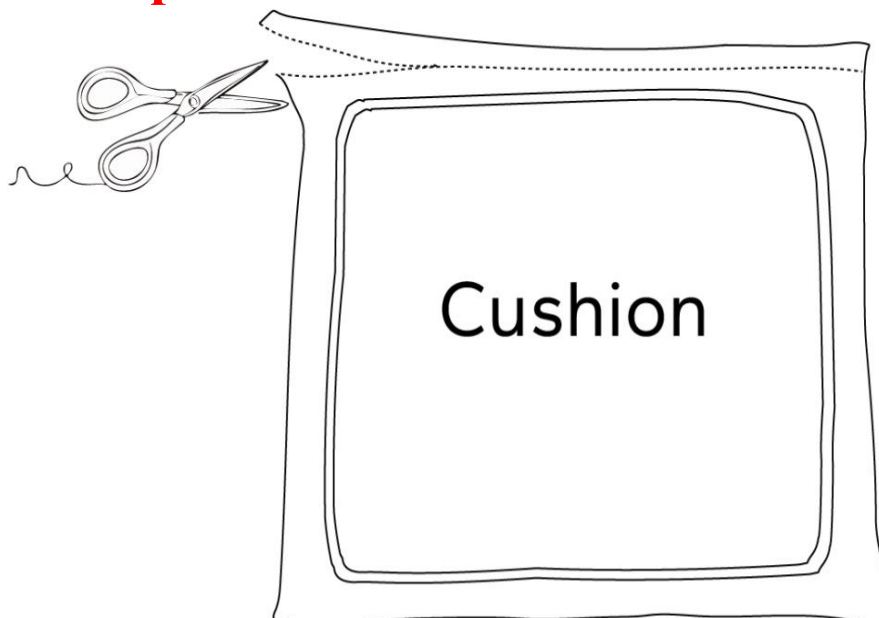

## Warning and Cautions:

Thank you for choosing our furniture. Please read and understand this entire manual before attempting to assemble or install the product.

### GENERAL BEST PRACTICES FOR ASSEMBLY

1. Familiarize yourself with the product and check all parts against the packing list. If any Parts are missing or damaged, do not install. Contact us immediately.
2. Some parts may contain sharp edges. Wear protective gloves, if necessary, during assembly.
3. Check all nuts and bolts periodically for tightness and, when required, tighten them again.
4. Pay attention to the parts orientation.
5. Save all packing materials until assembly is complete to avoid accidentally discarding smaller parts or hardware.

### IMPORTANT

- Make sure to place the washer on the bolt before inserting it into the bolt hole.
- To ensure the best fit, assemble loosely before tightening.
- Tighten all bolts after all parts are assembled.

### WARNINGS

 **Keep children and pets away from the working area during assembly and adjustments.**

1. Keep the assembly area at least 6 feet from any obstruction, such as a fence, garage, house, overhanging branches, laundry lines, or electrical wires.
2. When assembling and using this product, always follow basic safety precautions to reduce the risk of personal injury and product damage. Please read all instructions before assembly and use.
3. Check all bolts for tightness before use. **IMPORTANT** - check and tighten bolts often to keep them secure!
4. The chair is not to be used for standing purposes and will not function as a stool or step-ladder. Use on even surfaces only.
5. The chair supports a weight of 300lb (136.4 kg). Improper use of this product or failure to use it as directed may result in injury. Not intended for commercial use.

## WARRANTY





### •WHAT IS COVERED?





- The limited warranty is extended to the original purchaser and covers material and manufacturing defect, provided the item is properly maintained and used for personal residential purposes only.
- Warranty: 180 DAYS.
- Lost Accessories or Parts Policy: Costs for lost accessories or parts will be charged after 90 days from the date of purchase.





## MAINTENANCE



- STAIN RESISTANT CUSHIONS CARE:** Keep cushions in storage on rainy days.
- SPILLS:** Immediately wipe up spills using a white damp cloth. Repeat if necessary until the stain is gone. Allow cushions to air dry.
- **FABRIC CARE:** Hand wash with cold water, non-chlorine bleach when needed, and lay flat to dry. Cool iron if necessary. Do not dry clean.
- **RESIN WICKER PRODUCT CARE:**
  1. General Cleaning: Before use, clean the product with a soft, dry towel. When not in use, wipe off any dirt or loose debris. For regular cleaning, use a mild soap and water solution, rinse thoroughly, and dry completely.
  2. Weather Protection: To prolong the life of your resin wicker, avoid prolonged exposure to intense sunlight or heavy rain. Whenever possible, use a protective cover when the furniture is not in use, especially during extreme weather conditions.
  3. Avoid Harsh Cleaners: Do not use strong detergents or abrasive cleaners, as these may damage the finish.
- Regular Maintenance:** Over time, nuts and bolts may loosen. Occasionally check and re-tighten them on all products as needed.



## Assembly Instructions for 1PC Swivel Rocking Chair

<b>A</b>	<b>B</b>	<b>C</b>	<b>D</b>
			
1PC Left Arm	1PC Right Arm	1PC Seat Panel	1PC Chair Back

<b>E</b>	<b>F</b>	<b>G</b>	<b>H</b>
			
1PC Swivel Base	1PC Connecting Rob	1PC Connecting Rob	1PC U-shaped Fitting

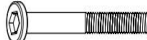
<b>I</b>	<b>J</b>	<b>K</b>	<b>L</b>
			
1PC Swivel Plate	4PCS Swing Arm	1PC Seat Cushion	1PC Back Cushion

<b>M</b>	<b>N</b>	<b>O</b>	<b>P</b>
			
<b>M6*20mm</b>	<b>M6*35mm</b>	<b>Ø16*Ø6.5*1mm</b>	<b>M6*45mm</b>
8PCS Bolt	18PCS Bolt	34PCS Washer	4PCS Bolt

<b>Q</b>	<b>R</b>		
			
<b>M6</b>	<b>M6</b>		
16PCS Spring Washer	16PCS Bolt		

**Tools:**

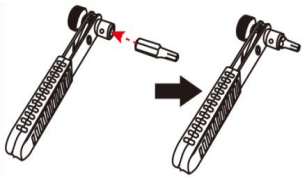

Socket Wrench



Allen Wrench

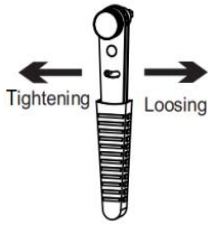



Ratchet Wrench

← Tightening
→ Loosing

1. Secure chair back (D) to left arm (A) with 2 washers (O) and 2 bolts (M) by using supplied tools. **Keep the bolts loose.**

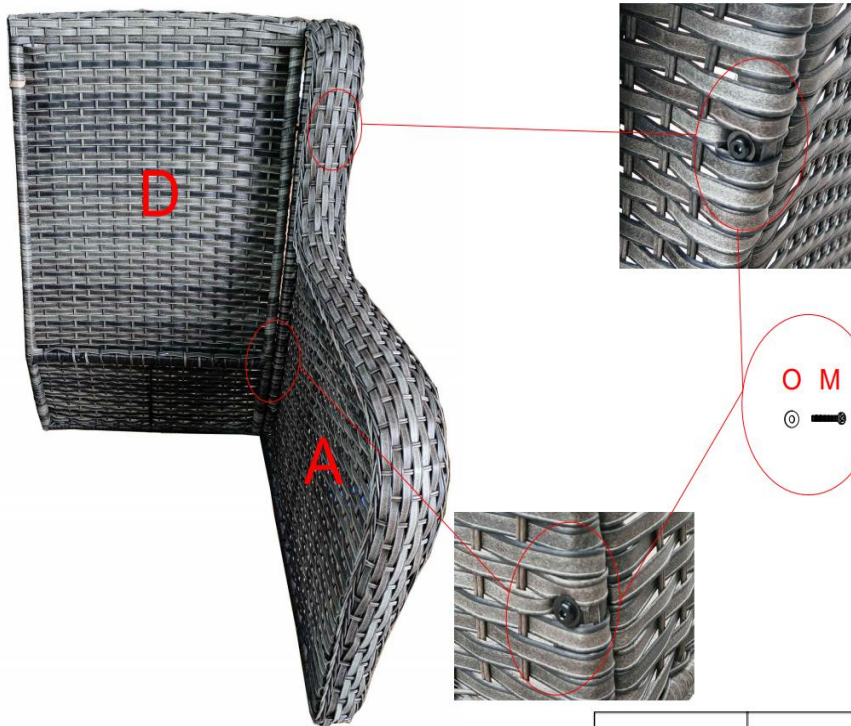
**Note: The hole of chair arm must face inside of seat.**





M		M6*20	2
O		Ø16*Ø6.5*1	2

2. Secure chair back (D) to right arm (B) with 2 washers (O) and 2 bolts (M) by using supplied tools. **Keep the bolts loose.**

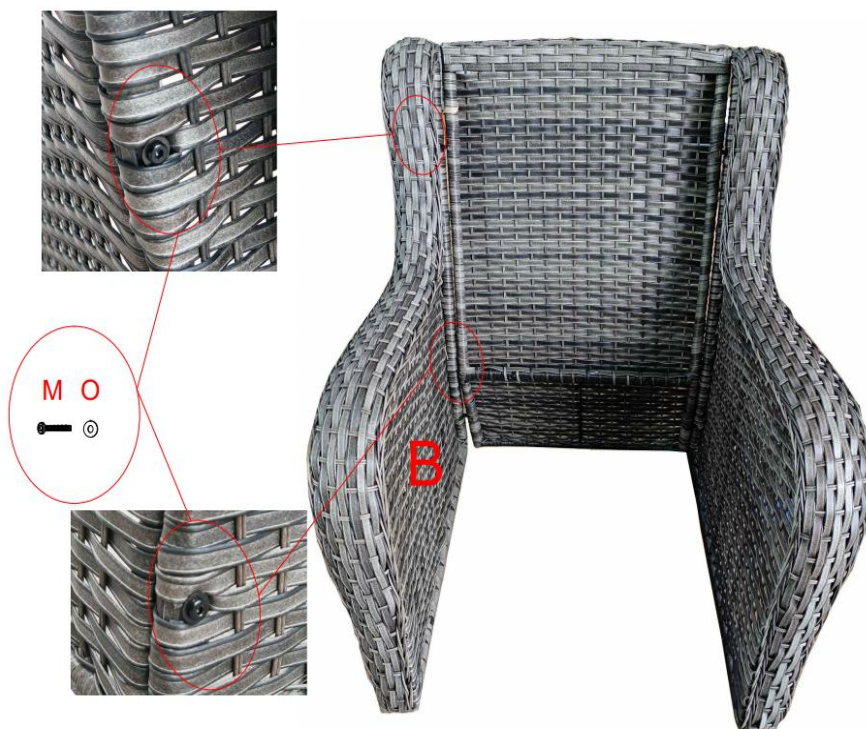

**Note: The hole of chair arm must face inside of seat.**

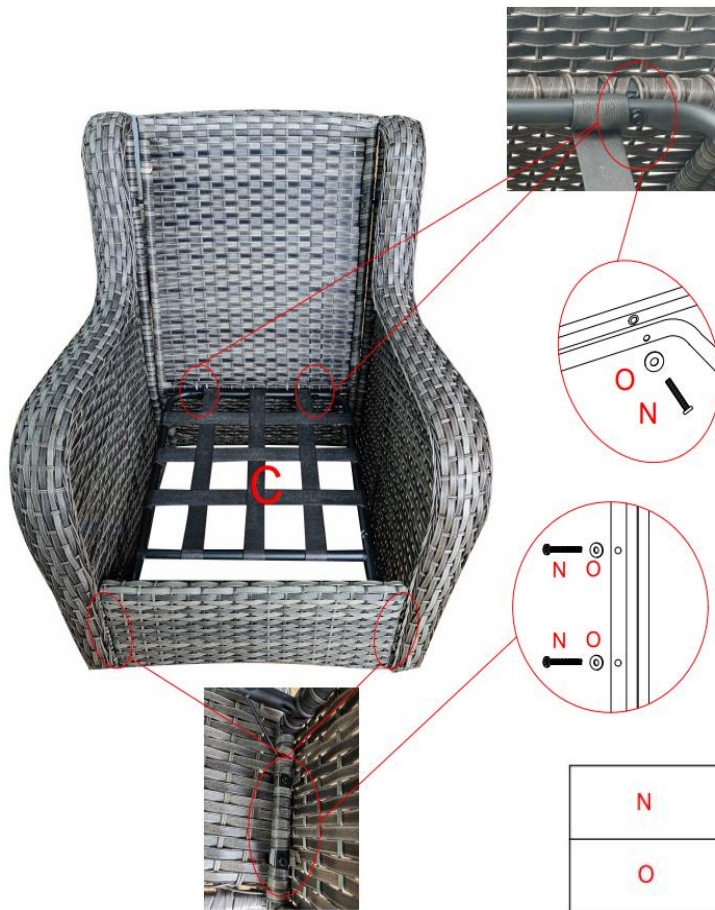

M		M6*20	2
O		Ø16*Ø6.5*1	2

3. Secure seat panel (C) to assembled chair back (D) and chair arms (A&B) with 6 washers (O) and 6 bolts (N) by using supplied tools. **Keep the bolts loose.**



N		M6*35	6
O		Ø16*Ø6.5*1	6



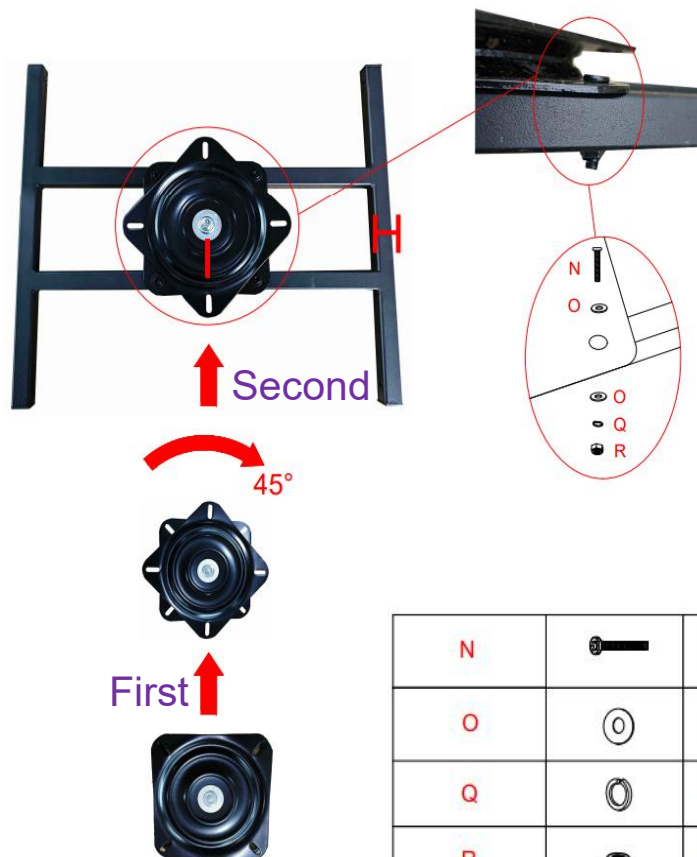

4. Put hands on the swivel plate (I) to press and rotate it 45 degrees, then secure swivel plate (I) to U-shaped fitting (H) with 8 washers (O), 4 spring washers (Q), 4 nuts (R) and 4 bolts (N) by using supplied tools, **fully tighten 4 bolts (N).**

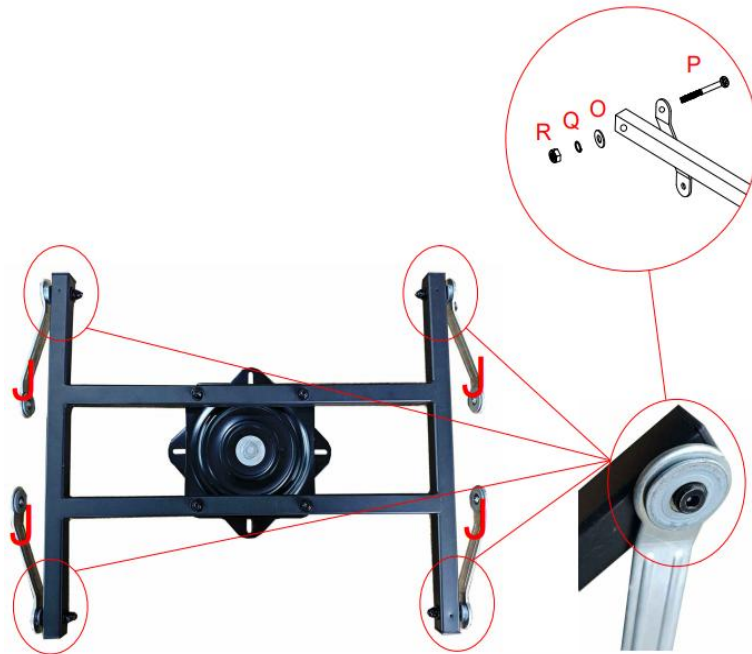

N		M6*35	4
O		Ø16*Ø6.5*1	8
Q		M6	4
R		M6	4



5. Secure swing arms (J) to assembled U-shaped fitting (H) with 4 washers (O), 4 spring washers (Q), 4 nuts (R) and 4 bolts (P) by using supplied tools, **fully tighten 4 bolts (P)**.



P		M6*45	4
O		Ø16*Ø6.5*1	4
Q		M6	4
R		M6	4

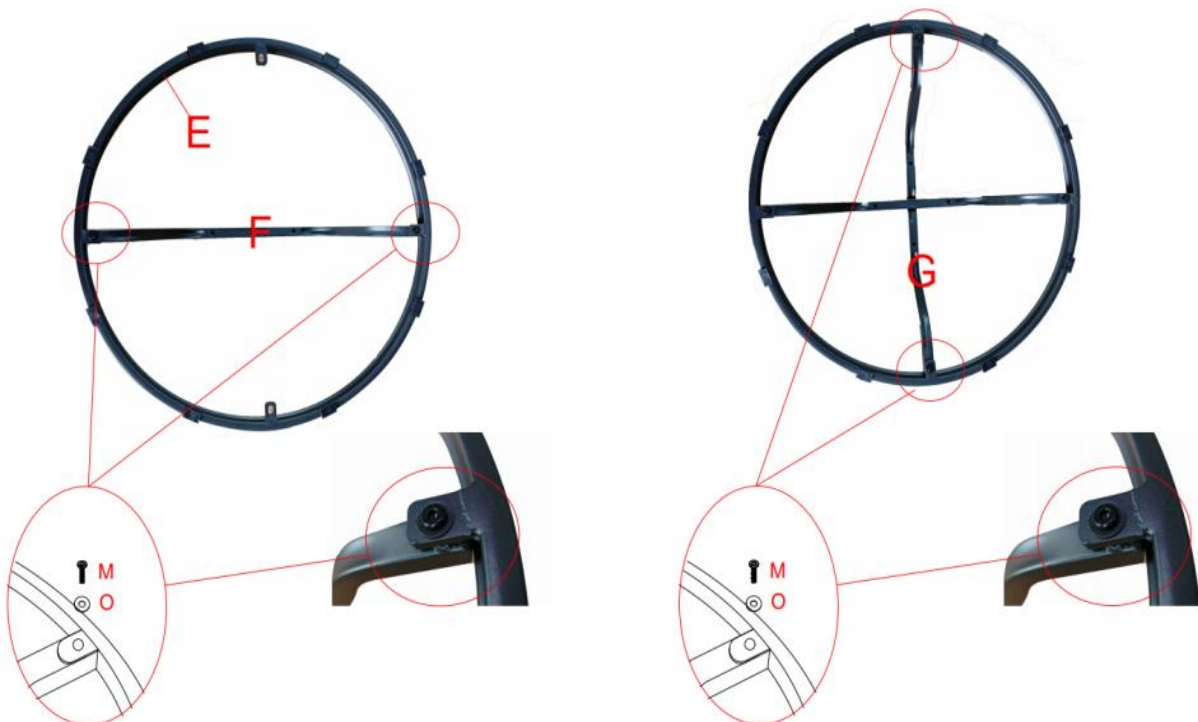



6. Secure swivel base (E) to connecting rods (F&G) with 4 washers (O) and 4 bolts (M) by using supplied tools, **fully tighten 4 bolts (M)**.

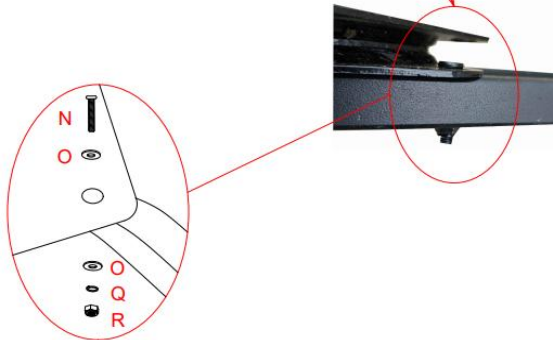
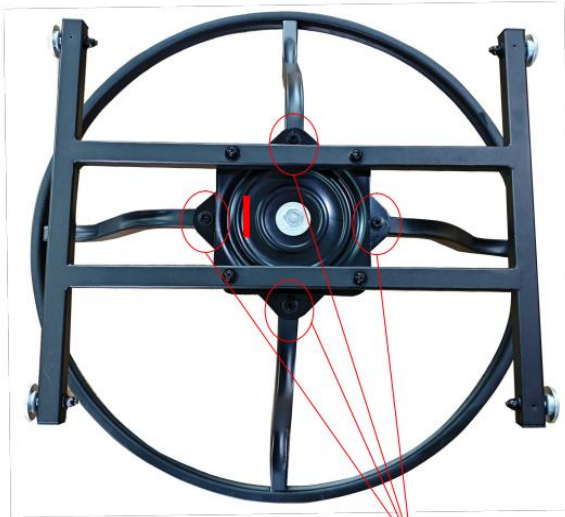

M		M6*20	4
O		Ø16*Ø6.5*1	4



7. Secure assembled swivel plate (I) to assembled connecting rods (F&G) with 8 washers (O), 4 spring washers (Q), 4 nuts (R) and 4 bolts (N) by using supplied tools, **fully tighten 4 bolts (N).**

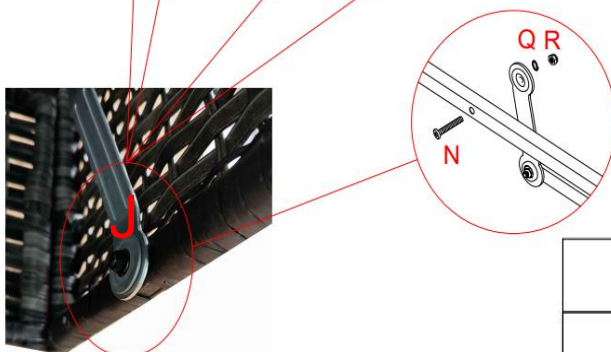
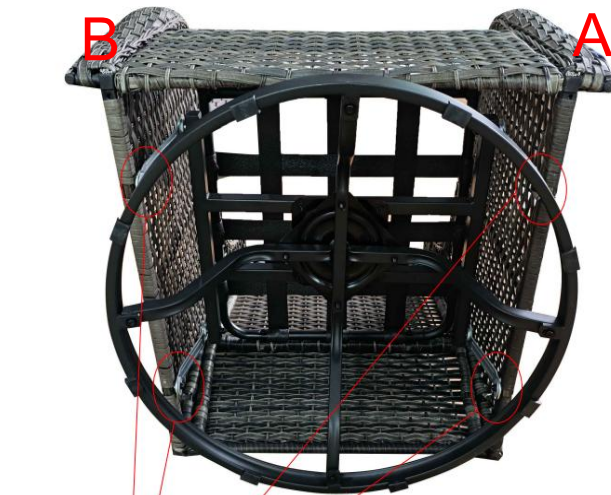

N		M6*35	4
O		Ø16*Ø6.5*1	8
Q		M6	4
R		M6	4

8. Secure assembled swing arms (J) to assembled arms (A&B) with 4 spring washers (Q), 4 nuts (R) and 4 bolts (N) by using supplied tools, **fully tighten all bolts now.**



N		M6*35	4
Q		M6	4
R		M6	4

**9. Put seat and back cushion (K&L) onto the chair, and it is ready to use now.**



**SPECIAL WARNING**

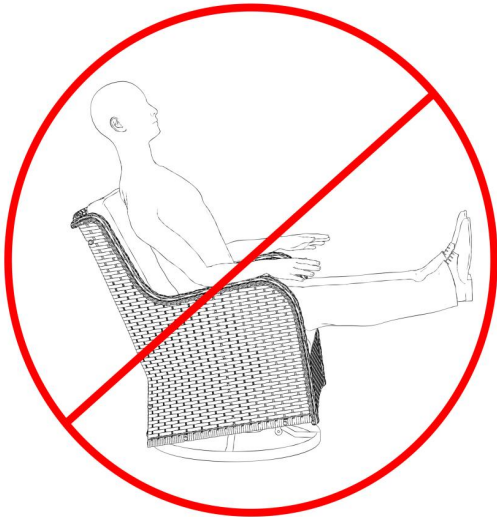

**THIS CHAIR IS NOT A TOY.  
DON'T OVER-SWING THE CHAIR.  
OVER-SWING THE CHAIR MAYBE  
MAKE THE CHAIR TIP OVER AND  
RESULT IN INJURY.**



**DO NOT STAND ON THE  
CHAIR. ANY IMPROPER USE  
OF THIS PRODUCT MAY  
RESULT IN INJURY.**