

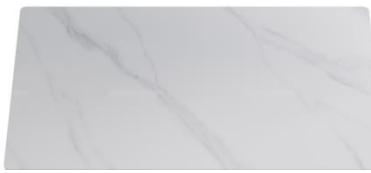





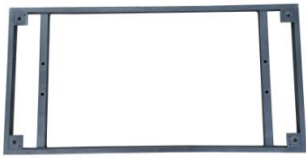

Installation

Hardware List		Hardware List	
 Table top	1	 Table leg	1
 Support frame	1	 8x16mm screw	4
 8x35mm screw	4	 Washer	8
 spare 4x15mm Self-tapping screws	8	 Hexagonal screw tap	1

1

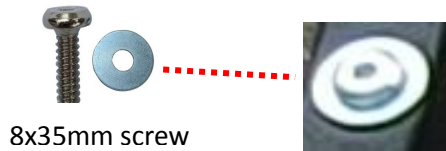

8x35mm screw



Tighten the screws to fix the support frame and table leg together.



2

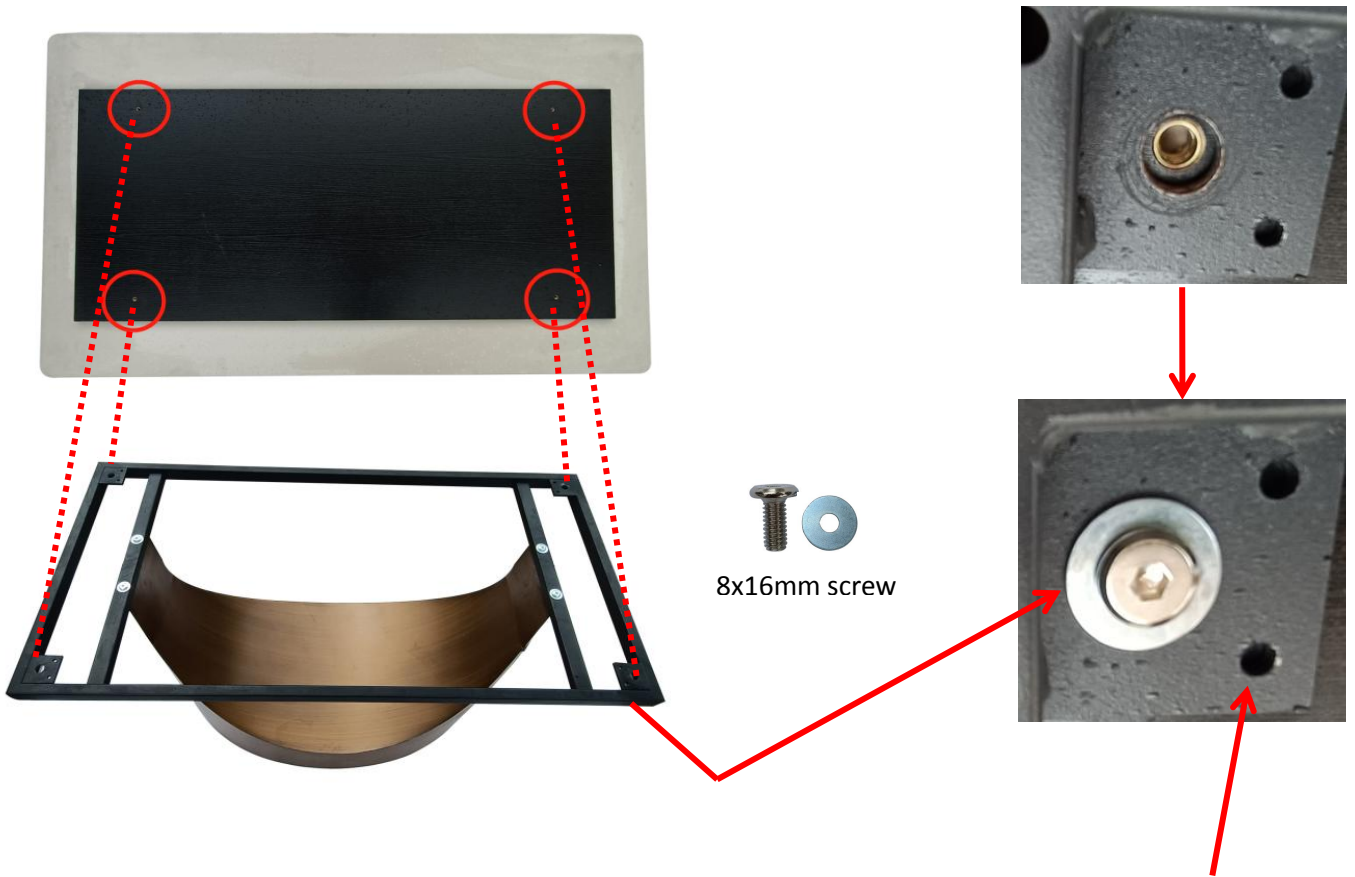

Put the table top on the table leg, make sure the reserved screw holes of the table top and the frame are corresponding, tighten 8x16mm screws to finish the installation.

This is a spare screw hole. When the 8x16mm screw fails to be screwed in, the hole can be fixed with a 4x15mm self-tapping screw. Either way will do.



MH-DC7

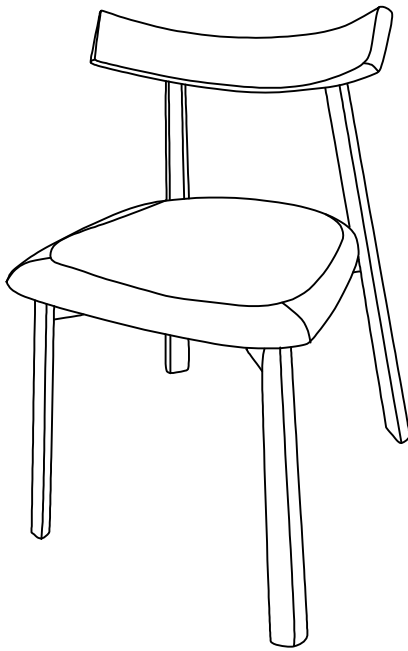

Notice:

1. Follow the installation instructions. Please confirm all accessories are preset before installation.
2. Do not fully tighten the screws during initial assembly. Fully tighten screws only once all pieces which are correctly assembled.
3. If you encounter any problems during installation, please contact our customer service.

	Reference Image	Qty
(A)		x1
(B)		x1
(C)		x1
(D)		x1
(E)		x1

	Reference Image	Qty
(1)		x4
(2)		x10
(3)		x4
(4)		x1

Please do not tighten the screws initially when installing them

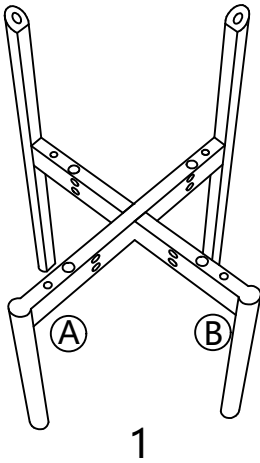

Please do not tighten the screws initially when installing them

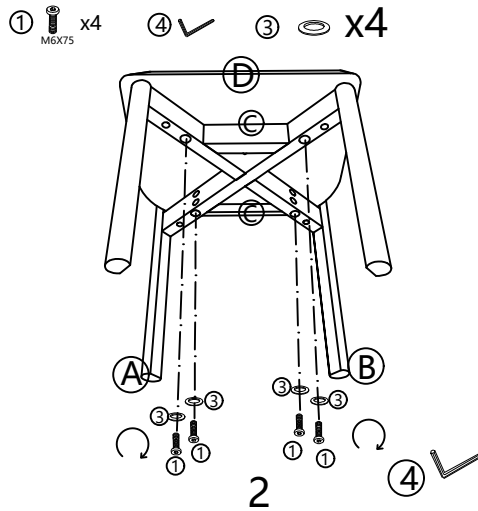

Please do not tighten the screws initially when installing them

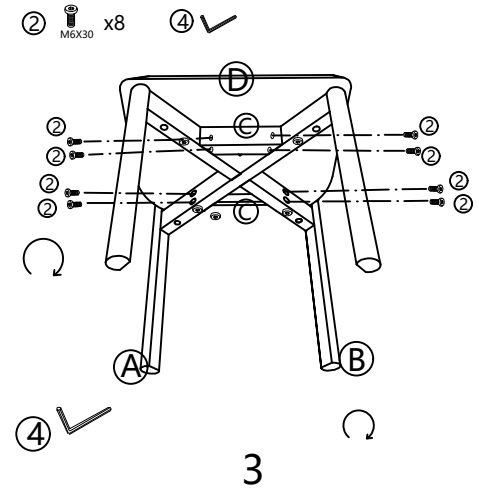

Notice:

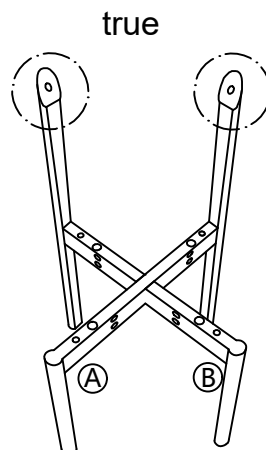
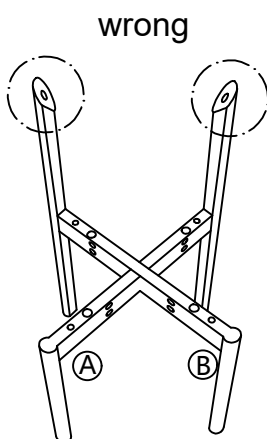

After all screws are installed, tighten all screws

