

Congratulations on the purchase of your new Glass Cabinet! We've made it very easy to install. Follow all instructions carefully.



CAUTION

Be Careful when using a knife or box cutter to open the packaging. Please read every step in the instructions before you begin installation. You are responsible for assembling, installing and taking care of your Cabinet according to the instructions. Users who fail to heed the instruction run the risk of injury, so please be careful and work with caution.

REQUIRED AND RECOMMENDED TOOLS

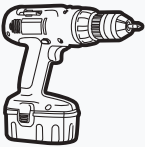

Drill/Driver

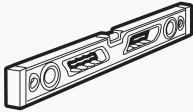

Level

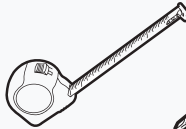

Tape Measure

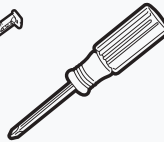

Screw Driver



Hammer



Lead Pencil

HARDWARE INCLUDED PER YOUR ORDER



Brackets
(Qty 2)



Anchor
(Qty - 4/6)



Screw
(Qty - 4/6)

1

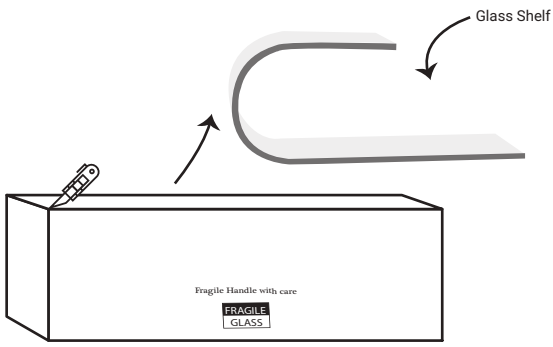

Remove the glass shelf and accessories from the packaging, as per picture.

2

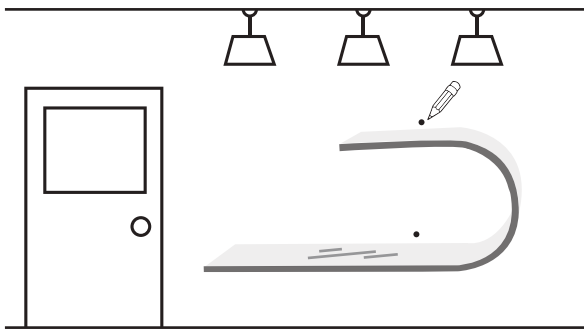

Use the LED pencil to mark where the brackets will go on the wall to hang the shelf.

3

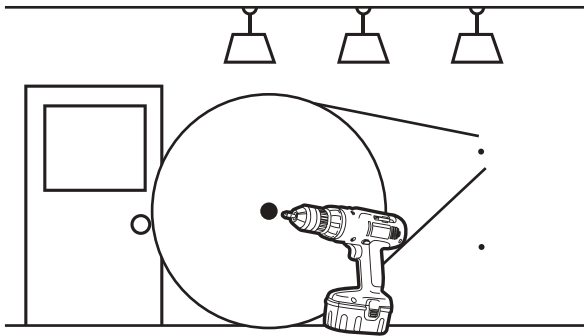

Now remove Shelf and drill the marked holes by drill machine.

4

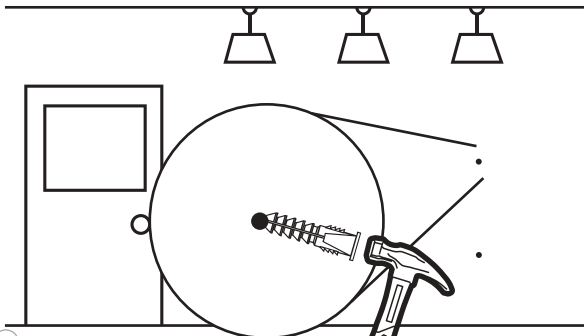

After drilling insert anchor in both holes by using hammer.

5

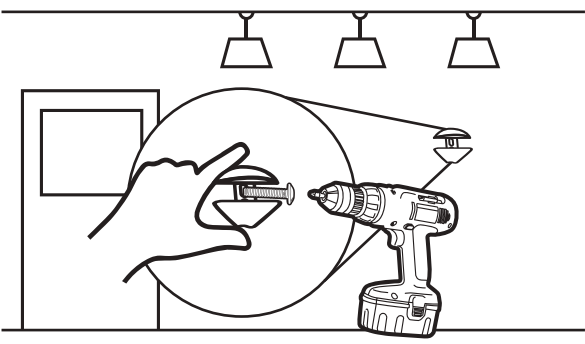

Hang the brackets on the wall with the screws, using a drill or screwdriver.

6

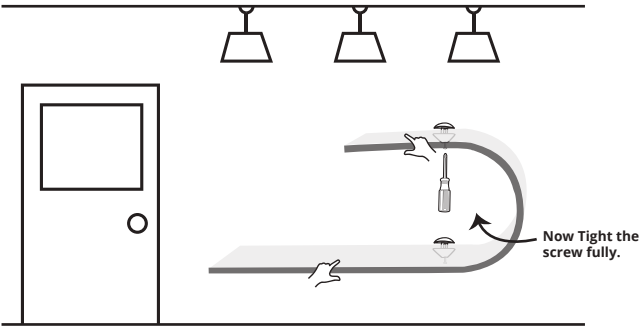

Install the glass shelf into the brackets and tighten the screws

7

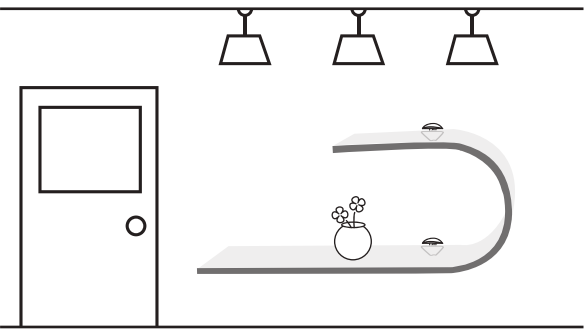

Congratulations!

You have successfully installed your Rectangle Shelf.

8