

# Assembly Instruction









## (1/2) Left Side Corner Sofa

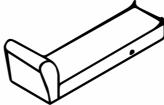
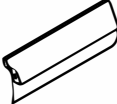
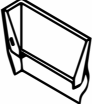

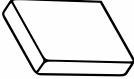
Legs & hardware are stored at the bottom of sofa, please take out the legs and hardware for assembly.

Note: Do not use power tools for assembly. Power tools increase the risk of over tightening which lead to splitting or cracking the wood.

### Component list

No	Drawing	Qty	Description
<b>A</b>		<b>1</b>	<b>LSF SOFA BASE</b>
<b>B</b>		<b>1</b>	<b>BACK</b>
<b>C</b>		<b>1</b>	<b>CORNER BACK</b>
<b>D</b>		<b>4</b>	<b>PLASTIC LEGS (6*6*2.75")</b>
<b>E</b>		<b>8</b>	<b>SCREW (Ø4*2.25")</b>
<b>F</b>		<b>3</b>	<b>SEAT CUSHIONS</b>
<b>G</b>		<b>1</b>	<b>LFS BACK CUSHION</b>
<b>H</b>		<b>1</b>	<b>MIDDLE BACK CUSHION</b>
<b>I</b>		<b>1</b>	<b>RSF BACK CUSHION</b>
<b>J</b>		<b>1</b>	<b>CORNER BACK CUSHION</b>
<b>K</b>		<b>4</b>	<b>PILLOW (21"X21")</b>

Step #1

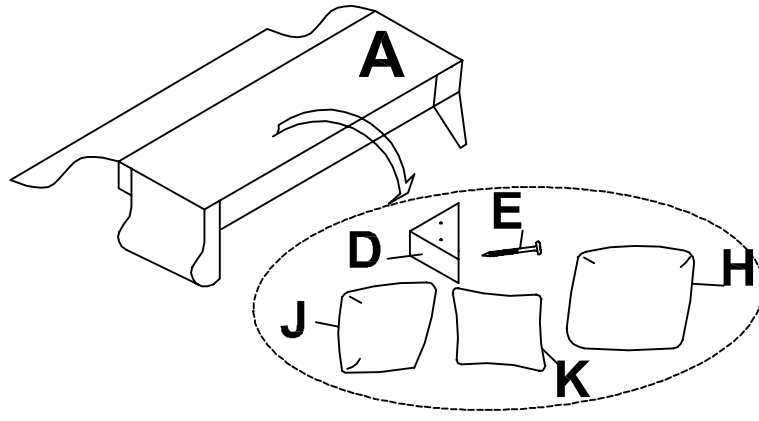

Step #2

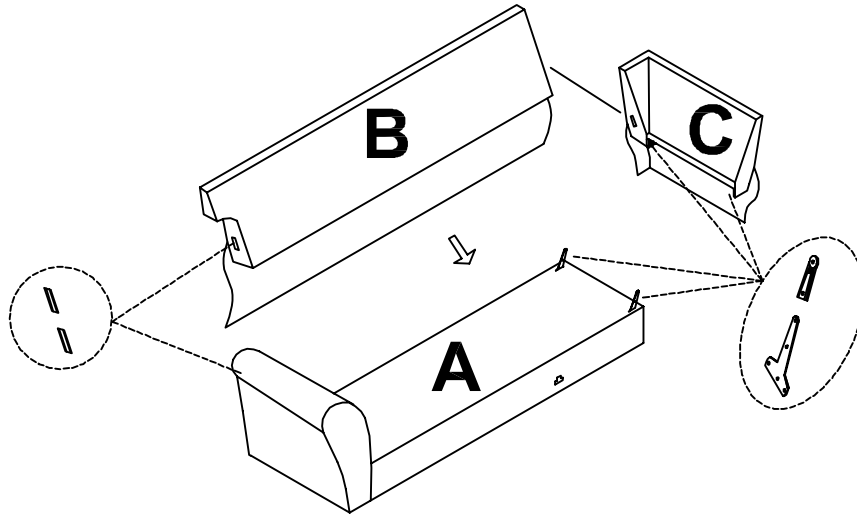

Step #3

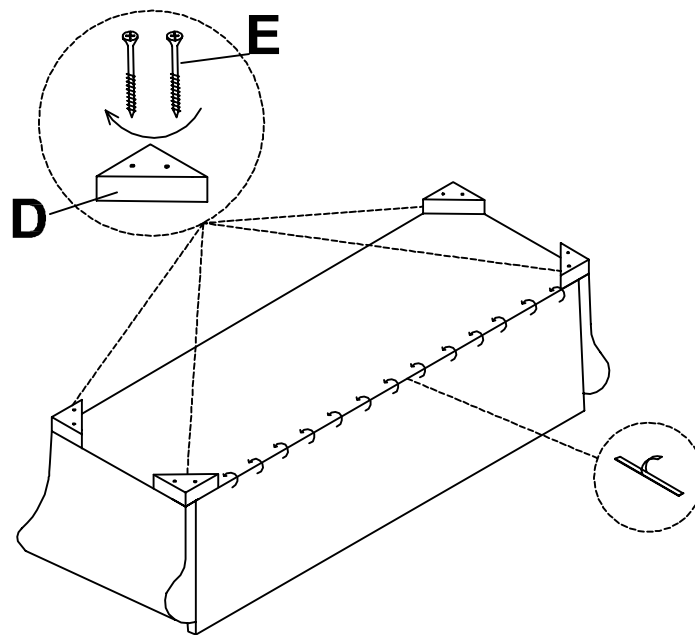

## Step #4

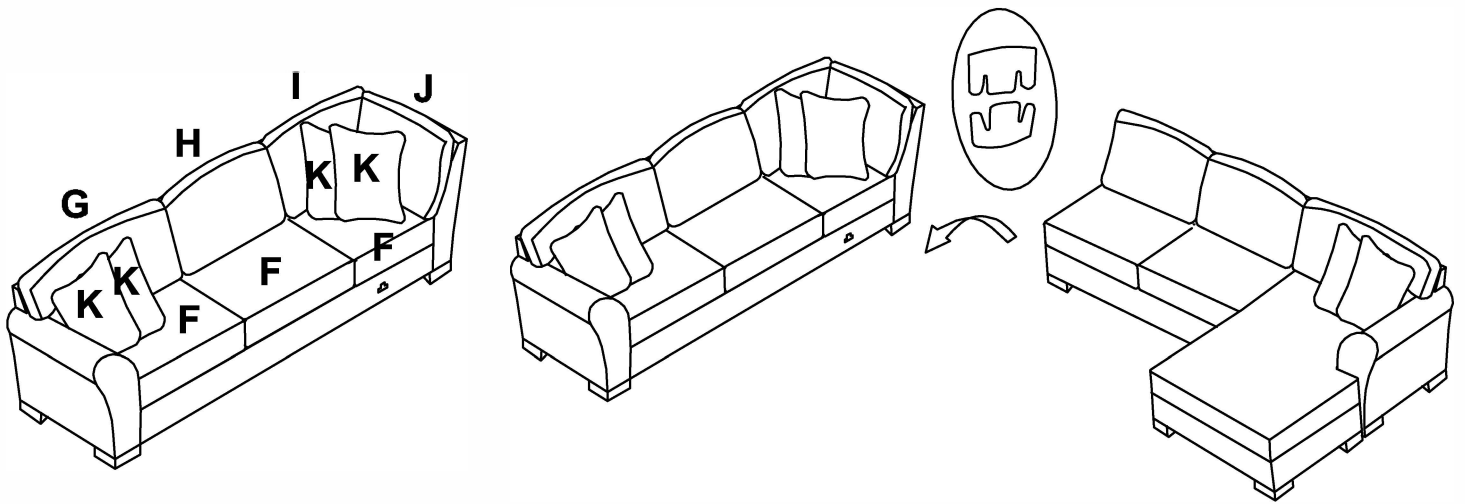

## ALL IN 1 SET

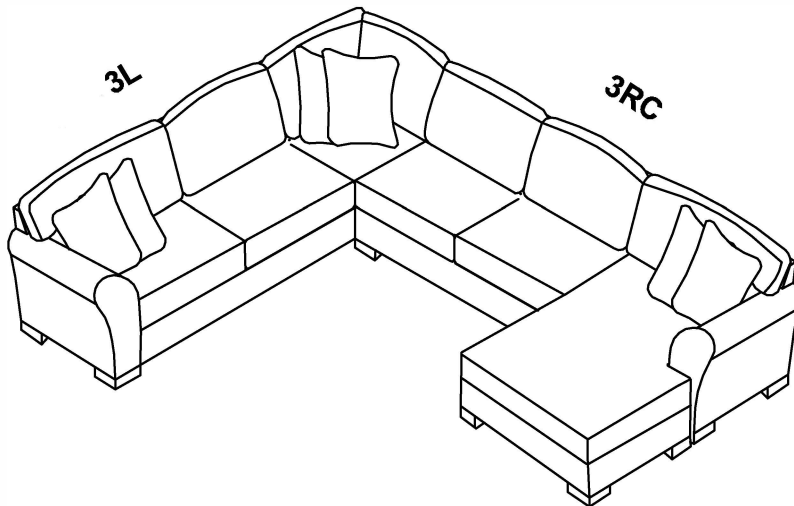

### Care Instruction for Chenille Furniture:

In order to maintain the original appearance of your Chenille Furniture please follow below simple care procedures:

- Avoid exposing furniture directly to sunlight or heating and air conditioning outlets. Sunlight and or exposure to heating and air conditioning outlets will fade/damage Chenille
- Vacuum or wipe with a soft cloth to remove dust.
- Hardware may loosen over time. Periodically check to make sure all connection are tight, Re-tighten if necessary



For items use on wooden floor, hard surfaces or carpets, it is recommended to Install protective pads under all legs and supports to avoid/prevent from damages/scratches and discoloration.

# Assembly Instruction







## (2/2) Right Side Sofa with Reversible Chaise

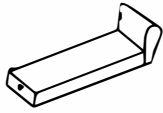
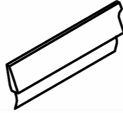
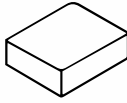

Legs & hardware are stored at the bottom of sofa, please take out the legs and hardware for assembly.

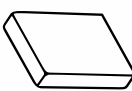
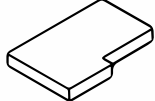
**Note:** Do not use power tools for assembly. Power tools increase the risk of over tightening which lead to splitting or cracking the wood.

### Component list

No	Drawing	Qty	Description
<b>A</b>		<b>1</b>	<b>RSF SOFA BASE</b>
<b>B</b>		<b>1</b>	<b>BACK</b>
<b>C</b>		<b>1</b>	<b>OTTOMAN BASE</b>
<b>D</b>		<b>8</b>	<b>PLASTIC LEGS (6*6*2.75")</b>
<b>E</b>		<b>16</b>	<b>SCREW (Ø4*2.25")</b>
<b>F</b>		<b>2</b>	<b>SEAT CUSHIONS</b>
<b>G</b>		<b>1</b>	<b>RSF SEAT CUSHION</b>
<b>H</b>		<b>1</b>	<b>RSF BACK CUSHION</b>
<b>I</b>		<b>2</b>	<b>BACK CUSHIONS</b>
<b>J</b>		<b>2</b>	<b>PILLOW (21"X21")</b>

### Step #1

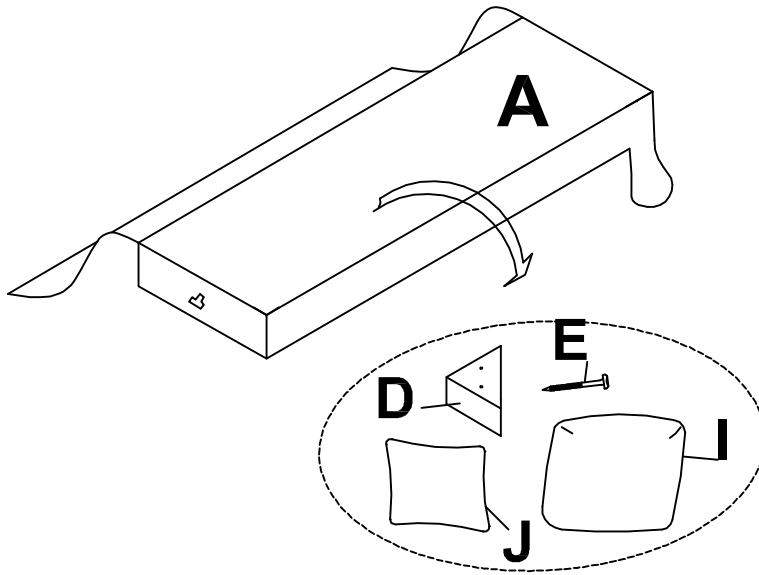

### Step #2

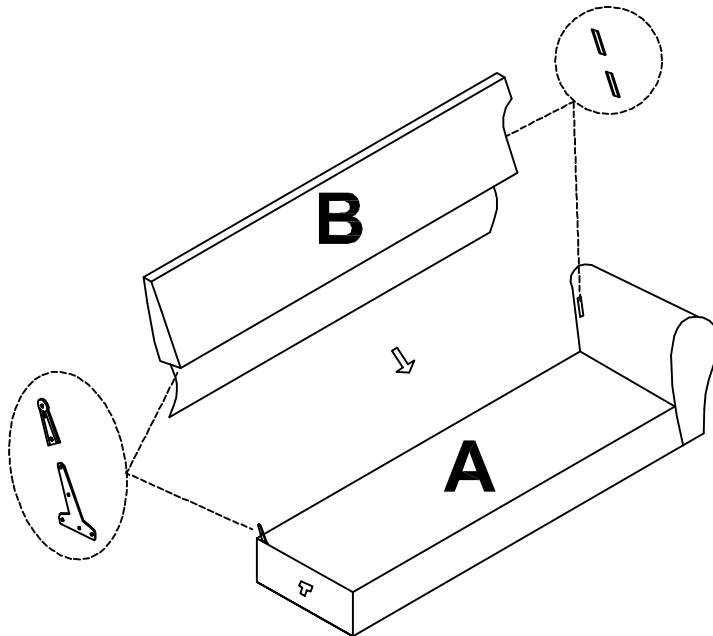

### Step #3

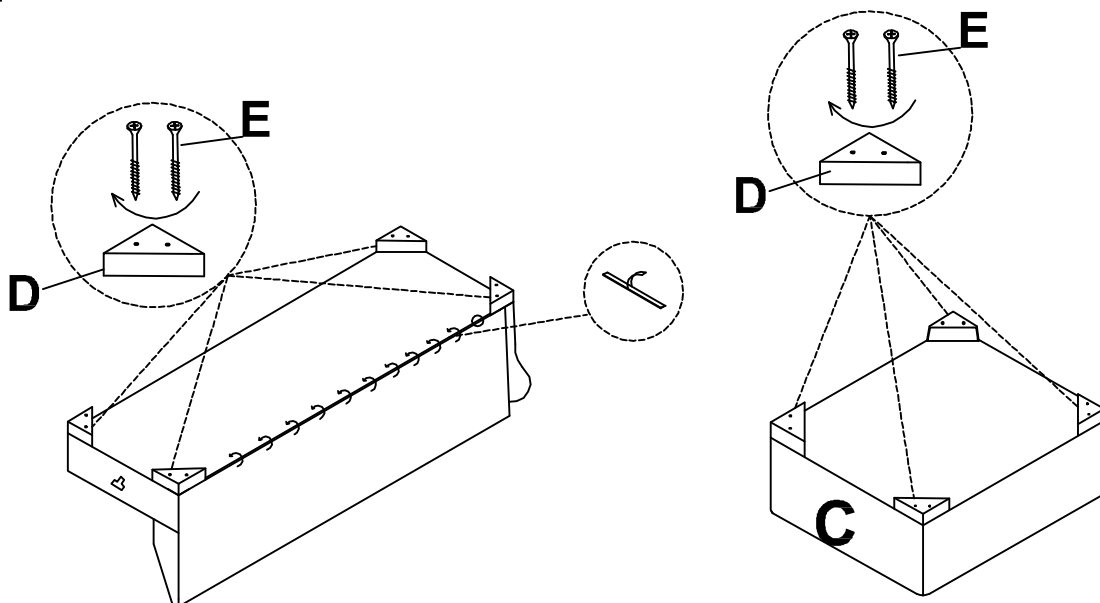

## Step #4

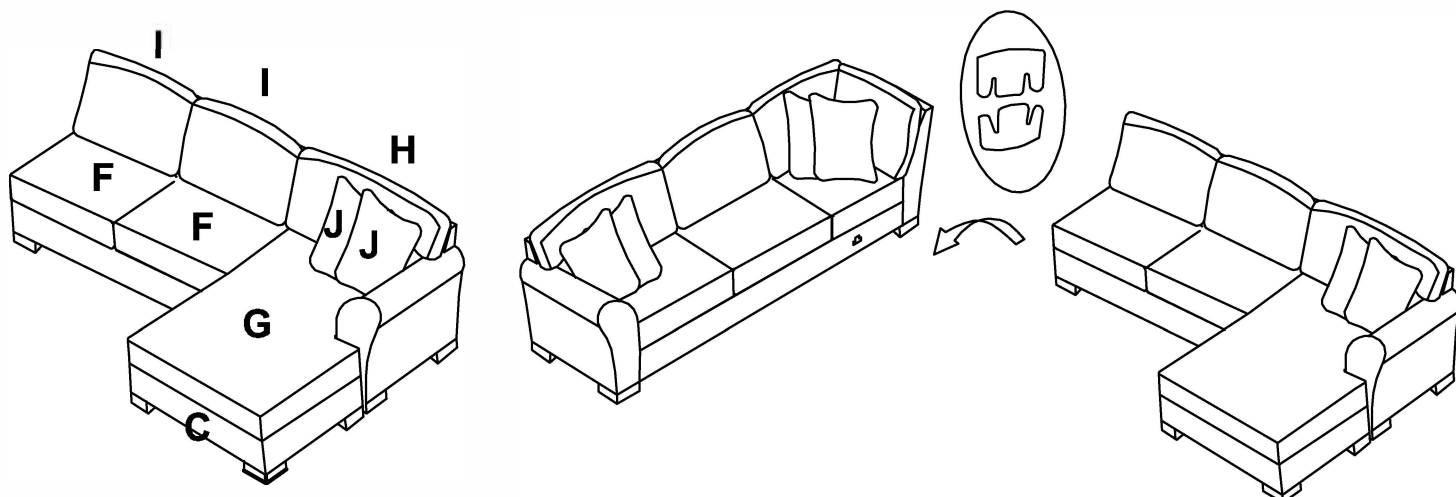

## ALL IN 1 SET

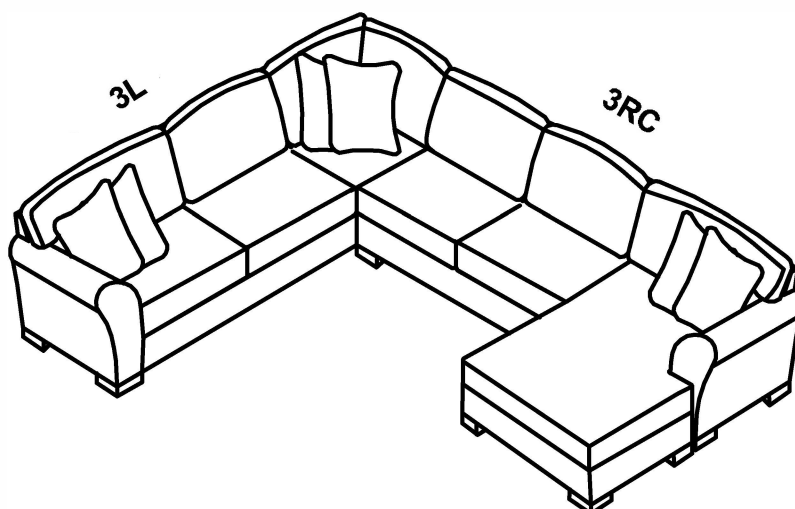

### Care Instruction for Chenille Furniture:

In order to maintain the original appearance of your Chenille Furniture please follow below simple care procedures:

- Avoid exposing furniture directly to sunlight or heating and air conditioning outlets. Sunlight and or exposure to heating and air conditioning outlets will fade/damage Chenille
- Vacuum or wipe with a soft cloth to remove dust.
- Hardware may loosen over time. Periodically check to make sure all connection are tight, Re-tighten if necessary



For items use on wooden floor, hard surfaces or carpets, it is recommended to Install protective pads under all legs and supports to avoid/prevent from damages/scratches and discoloration.