

INSTRUCTION MANUAL

CLOUD SOFA SECTIONAL

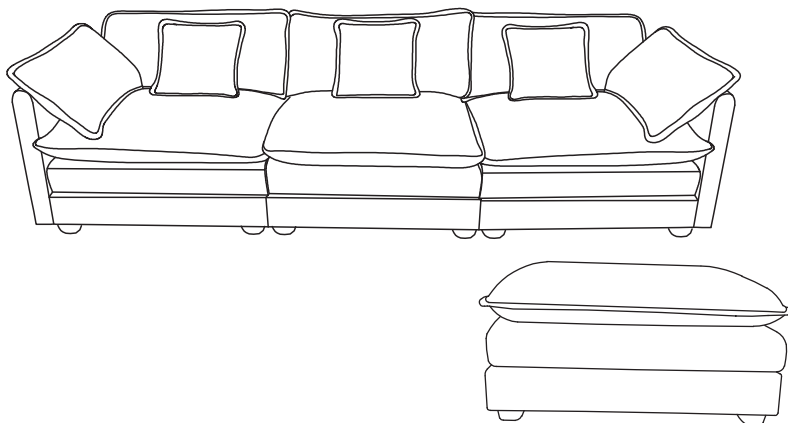

SM5016H

Note:

1. Please confirm all parts are correct before you assemble
2. This product is shipped in 2-6 boxes (Depending on the seat number you choose), if you only receive one box first, don't worry, other boxes are on the way.
3. Do not tighten fastening fully until assembly is complete
4. DO NOT USE POWER TOOLS. Power tools can overtighten screws.

If you have any questions, please feel free to contact us:

Email: Sofafurniture@163.com

FAQ

Q1:Missing parts when received.

A1: If you find some parts are missing from the box, please kindly send us messages to let us know the name of missing parts according to the parts list of the instruction, we will send you the replacement asap.

Q2: Difficult to assemble

A2:It is best for two people to install the sofa. If there are any problems during the installation process, you can take photos and send them to us, and we will reply promptly. There are also installation videos on our Amazon page that you can view online.

Q3: Some parts were damaged when arrived.

A3: Please send us the clear photo of the damaged part as an attachment, we will check it and offer you the best solution soon.

Q4:Only received one or two boxes.

A4: We normally ship all boxes on the same day, but the boxes may not be delivered together because of the carrier. The delivery time interval between the packages will not normally exceed three days. And you can also contact the seller and ask for the delivery time of the other boxes.

Q5:Want to return the product.

A5: Before returning the item, please contact us regarding the return issue. Please make sure that the box packaging is complete, the product is not damaged, stained, and does not affect secondary sales. Products returned without the original packaging may be rejected, and we may request pictures to be provided.

Many Different Sectional (2 Seats-6 Seats)

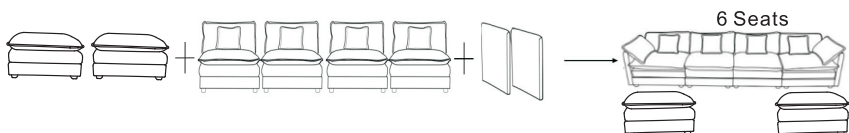
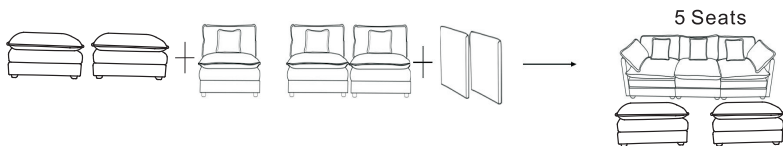
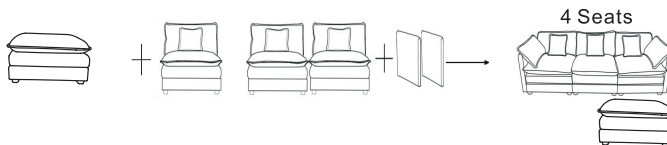
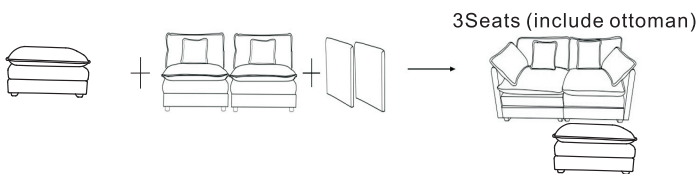
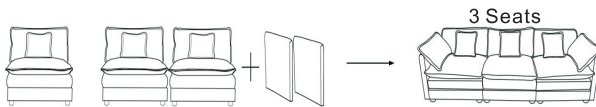
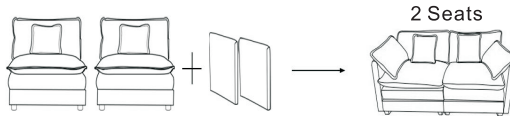

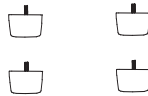
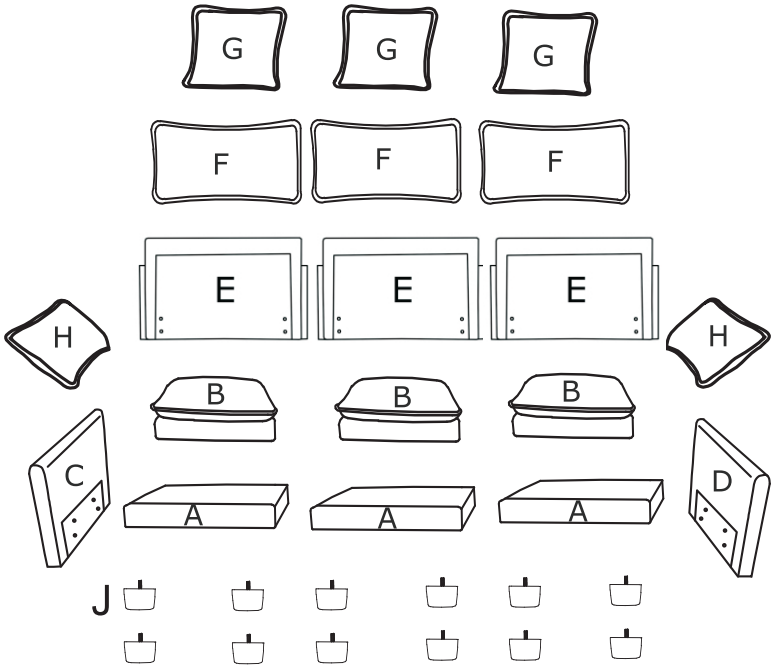

TOOLS REQUIRED:  SCISSORS(NOT INCLUDED)

BOX A Double Seats

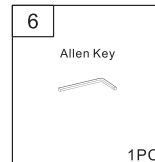
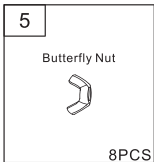
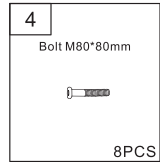
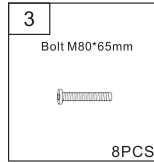
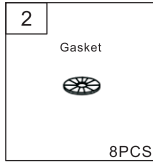
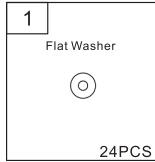
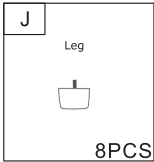
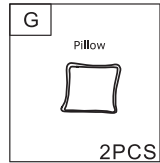
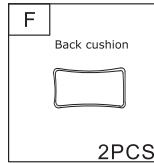
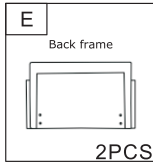
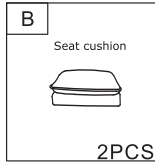
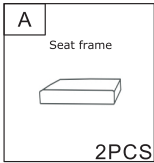

BOX B Single Seat

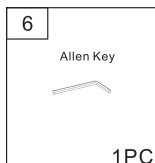
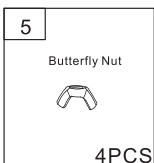
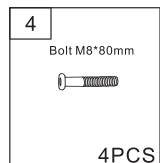
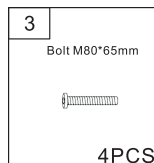
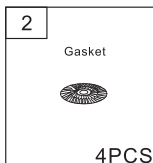
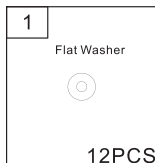
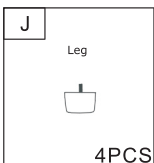
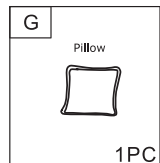
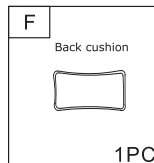
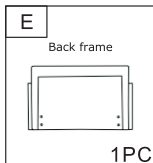
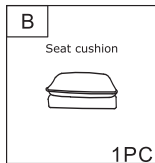
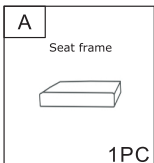

BOX C Armrests

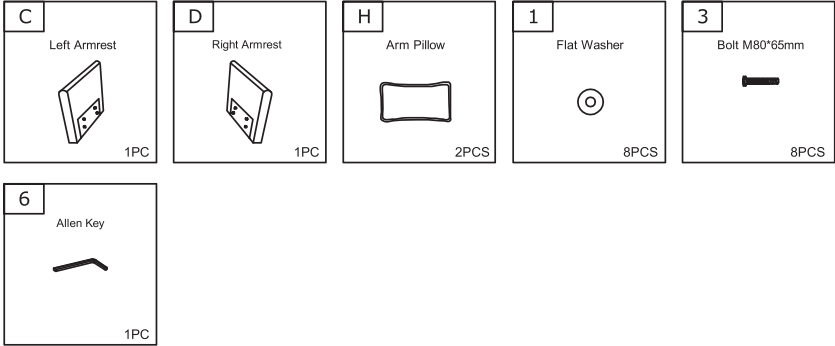

BOX D Ottoman*2

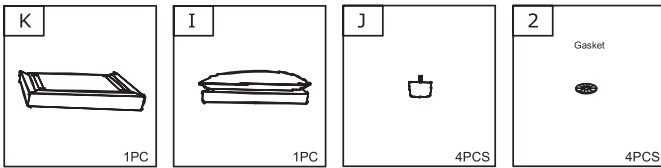

BOX F Armrests&Single Seat

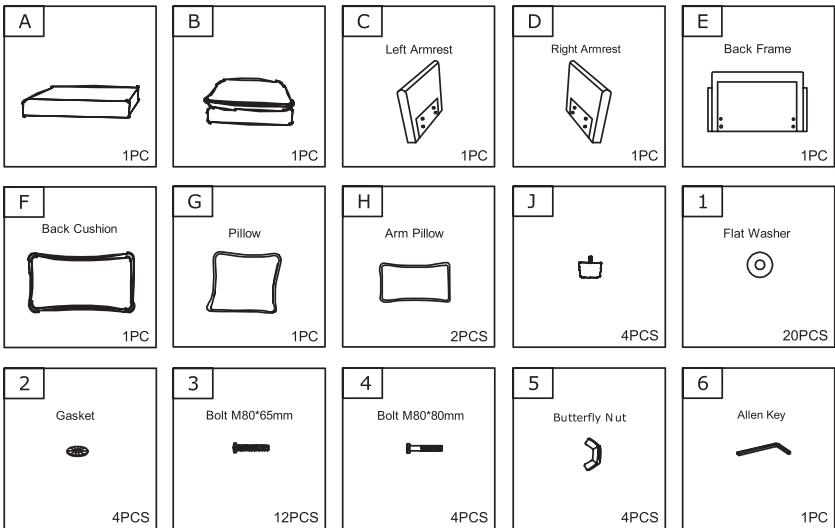

BOX G Armrests&Ottoman*2

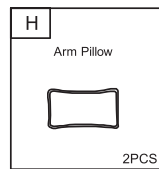
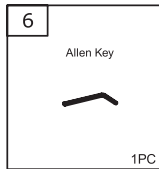
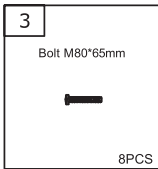
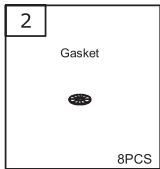
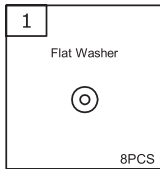
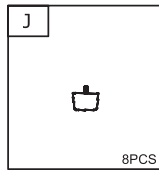
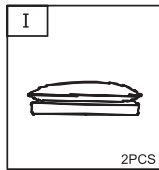
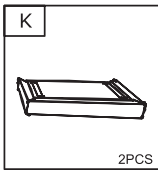
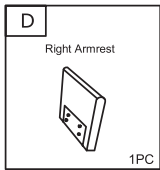
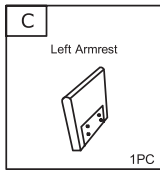

BOX H Armrests&Ottoman*1

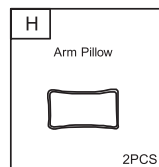
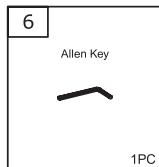
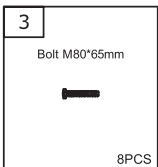
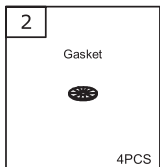
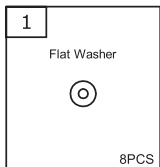
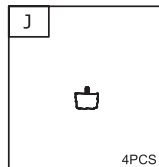
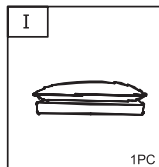
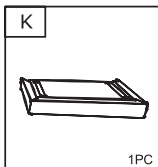
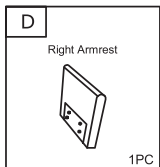
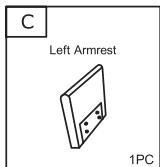



DIAGRAM 1 (Assemble th Armrest (left))

Assemble the Left Armrest(Part C) to the Seat Frame(Part A) with Washers(Hardware 1) and Screws(Hardware 3).

1		4PCS
3	 M8X65	4PCS

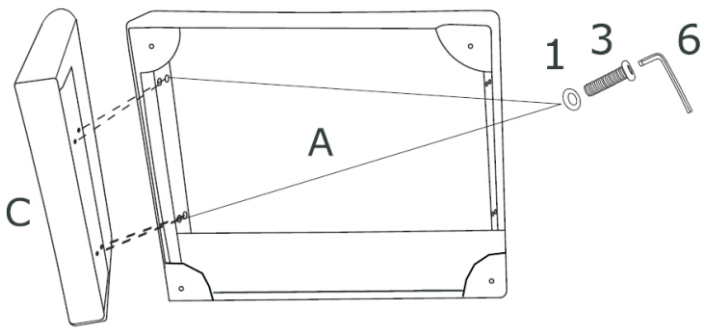



DIAGRAM 2 (Assemble the Armrest (right))

Assemble the Right Armrest(Part D) to the Seat Frame(Part A) with Washers(Hardware 1) and Screws(Hardware 3).

1		4PCS
3	 M8X65	4PCS

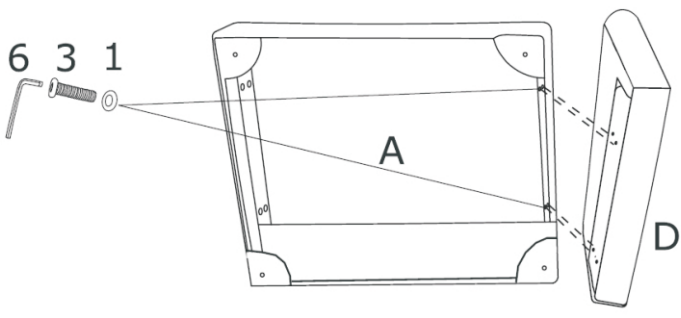





DIAGRAM 3 (Assemble the Seat frame)

Assemble Seat Frame(Part A) and Seat Frame(Part A) with Butterfly Nuts(Hardware 5) Washers(Hardware 1) and Screws(Hardware 4).

1		16PCS
4	 MBX80	8PCS
5		8PCS

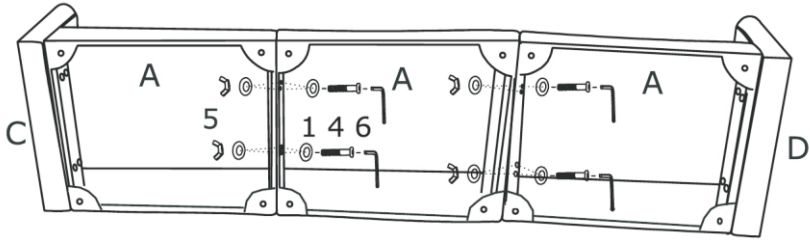

DIAGRAM 4 (Assemble the Leg)

Assemble the Legs(Part J) on the sofa with Gaskets(Hardware 2).

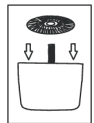
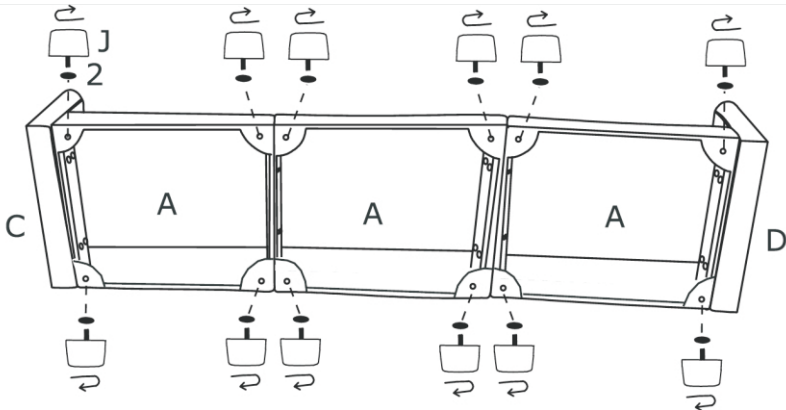

DIAGRAM 5 (Assemble the Leg)

Assemble the Legs(Part J) on the Ottoman frame with Gaskets(Hardware 2) .

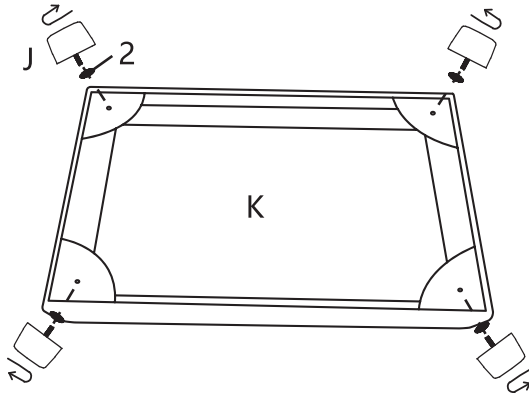



DIAGRAM 6 (Assemble the Back frame)

1		12PCS
3	 M8X65	12PCS

Insert the Back frame (Part E) into the designated holes, using Washers (Hardware 1) and Screws (Hardware 3) to 70% tightness, and then tighten all the Bolts on the seat.

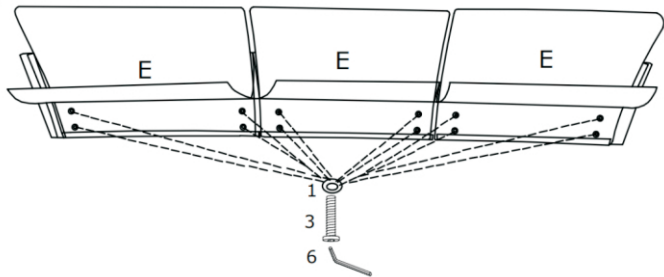
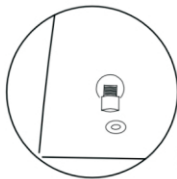

DIAGRAM 7

The cushions are packaged by vacuum compression. After opening the package, they rebound quickly within 4 hours. If the fabric has wrinkles, they will basically disappear after about 72 hours.

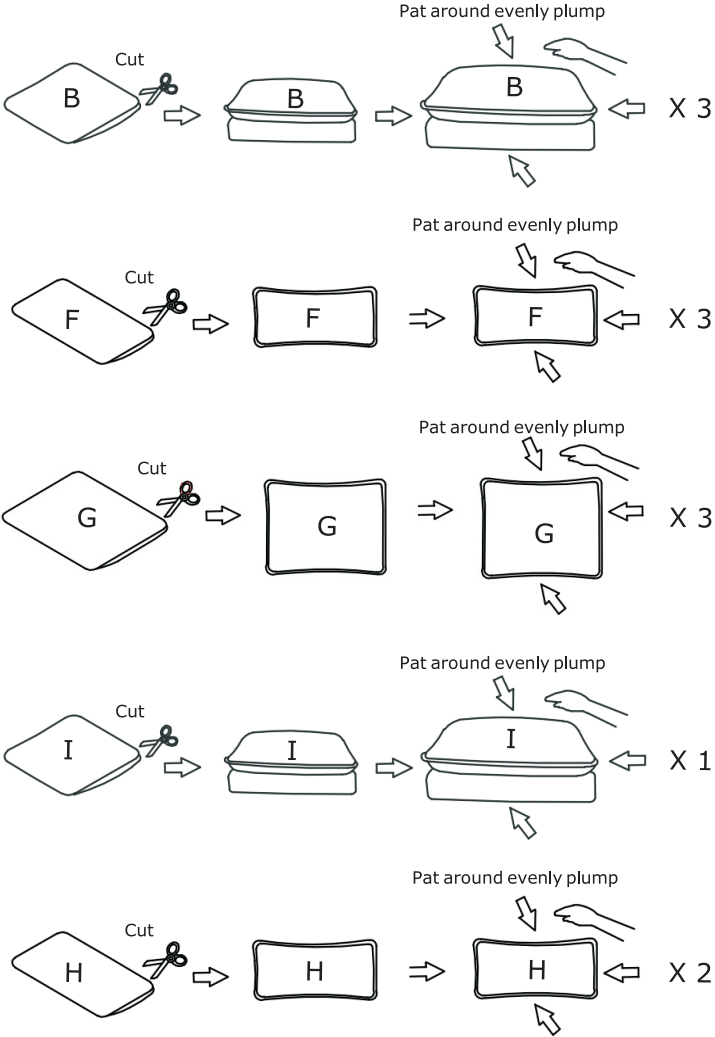

DIAGRAM 8 (Assemble the cushion)

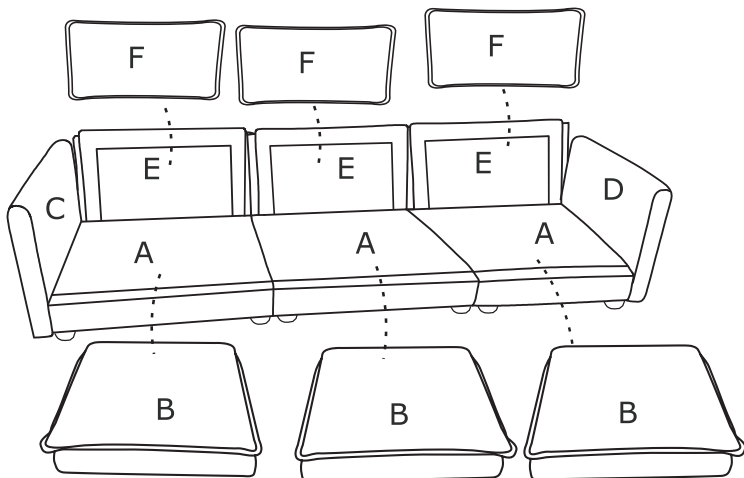

DIAGRAM 9 (Assemble the Pillow)

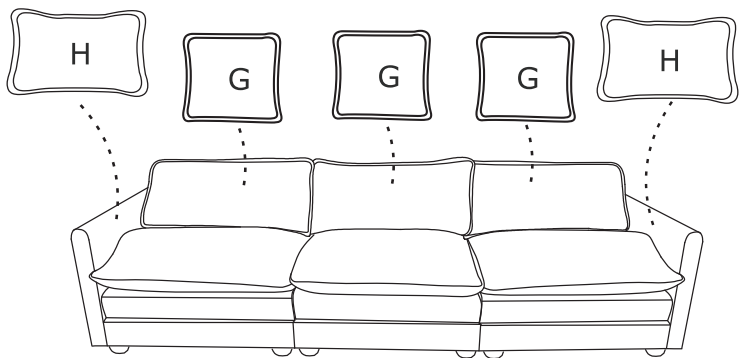

DIAGRAM 10(Assemble the Ottoman cushion)

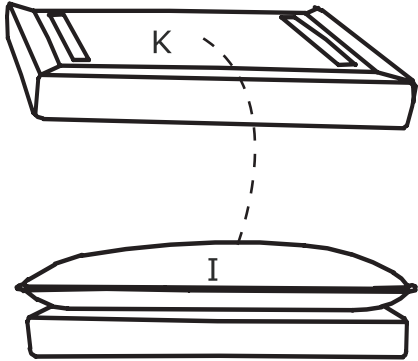

DIAGRAM 11

If the fabric has wrinkles, it will basically disappear after standing for 72 hours. Well done!! You can enjoy your leisure time on the sofa now.

