

ASSEMBLY INSTRUCTION

This set will be shipped by 2 boxes and they may arrive on different days.
If both packages arrived but parts missing, please contact customer service.

DayBed 190x90cm

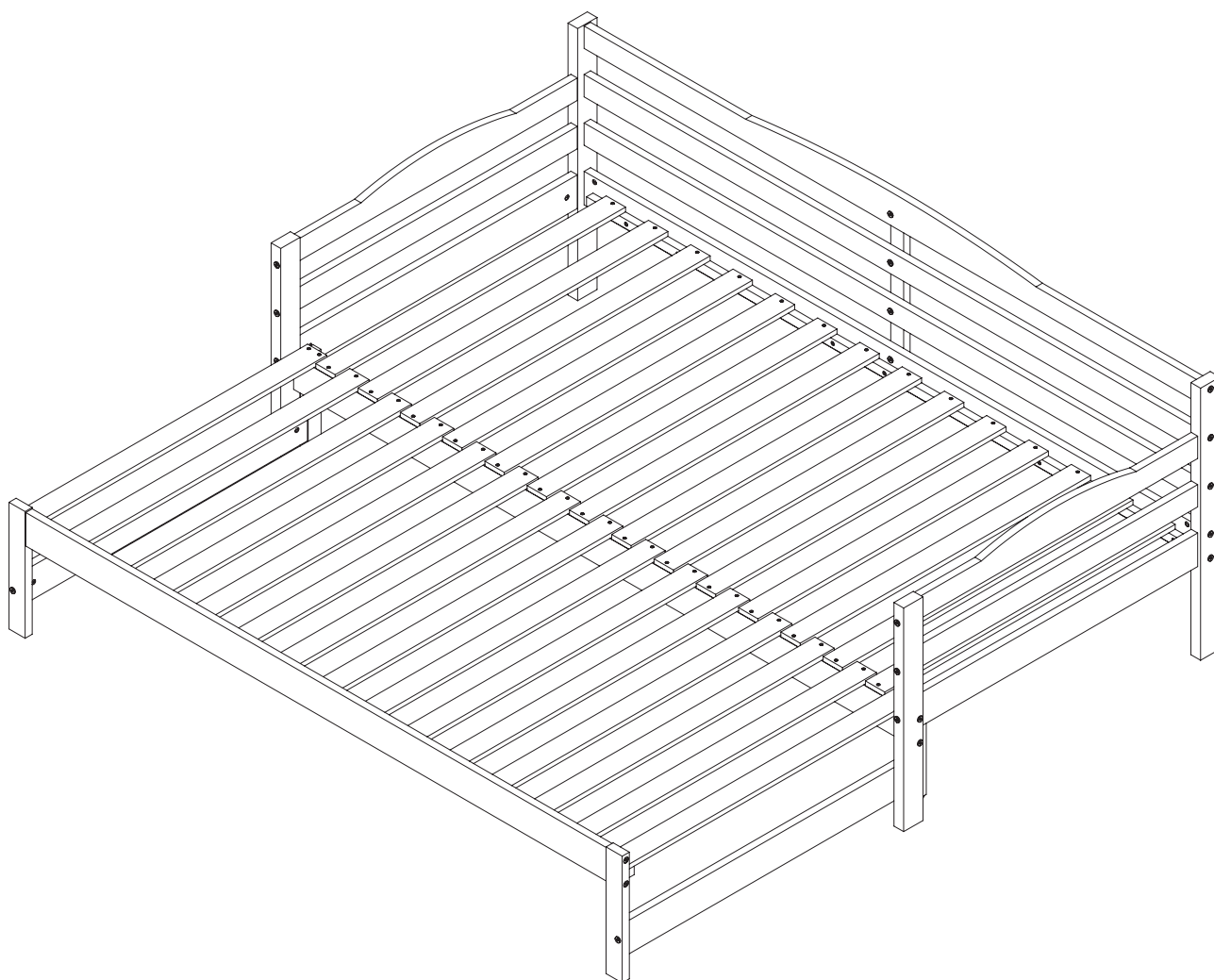

D Gebrauchsanweisung

NL Gebruiksrichtlijnen

IT Istruzioni per l'uso

CZ Pokyny k použití

HU Használati útmutató

PT Instruções de utilização

SK Pokyny k použitiu

GB Instructions for use

FR Instructions d'utilisation

PL Instrukcja obsługi

ES Instrucciones de empleo

RO Instrucțiuni de folosire

RU Инструкция по монтажу

TR Kullanım talimatları

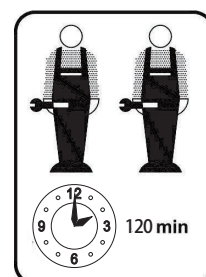

Reminder/ Hinweis



D CH AT LI LU
GB US
FR BE NC
NL
IT

Kleinteile und Verpackungsfolien von Kindern fernhalten!
Keep small parts and plastic film out of the reach of children!
Tenir les petites pièces et les films plastiques hors de la portée des enfants!
Houd de kleine onderdelen en de plastic folie uit de buurt von kinderen!
Tenere i componenti di piccole dimensioni e le pellicole di plastica fuori dalla portata dei bambini!

SI
XS HR BA
HU

Majhnih delov in embalažne folije pri montaži pohištva hranite izven dosega otrok!
Male dijelove i foliju za pakovanje prilikom montaže namještaja držite dalje od djece
Bútorszerelés közben a kis alkatrészek és a csomagoló fóliák gyermekektől távol tartandók!

BG

Дребни детайли и опаковъчни фолиа да се държат далеч от деца при монтажа на мебелите!

CZ SK
PT
RO
ES

Při montáži nábytku uchovávejte drobné díly a obalové fólie z dosahu dětí!
Mantenha peças pequenas e películas de embalagem afastadas de crianças!
Țineți departe de copii piesele mici și folia de ambalat la montarea mobilei!
¡Durante el montaje, mantenga alejados de los niños las piezas pequeñas y el material plástico de embalaje!



D CH AT LI LU

Möbelmontage muss auf ebenem Untergrund erfolgen. Bei Wandmontagen immer geeignetes Befestigungsmaterial verwenden.

GB US

Furniture must be assembled on a flat surface. For assembly to the wall only use suitable fixing materials.

FR BE NC

Le meuble doit être monté sur une surface plane. Pour le montage mural, utilisez des accessoires de fixation adapté au type de mur.

NL

De meubels dienen op een vlakke ondergrond te worden gemonteerd. Voor wandmontage moeten geschikte bevestigingsmaterialen worden gebruikt.

IT

Il montaggio dei mobili deve avvenire su un fondo piano. Per il montaggio si prega di utilizzare solo materiali adatti.

SI

Pohištvo je treba montirati na ravni podlagi. Pri stenski montaži vedno uporabite pritrditveni material.

XS HR BA

Namještaj se mora montirati na ravnoj podlozi. Kod montaže na zid uvijek koristite prikladan materijal za pričvršćivanje.

HU

A bútorszerelését sík felületen kell végezni. Falra szereléshez mindig megfelelő rögzítőanyagot kell használni.

BG

Монтажът на мебелите да се извършва на равна основа. При стени монтаж винаги да се използва подходящ крепежен материал.

CZ SK

Montáž nábytku provádějte na rovném podkladu. Při montáži na stěnu používejte vždy vhodný připevňovací materiál.

PT

A montagem precisa de ser realizada sobre uma superfície plana. Use sempre material de fixação adequado para montagens em paredes.

RO

Montarea mobilei trebuie să se realizeze pe o pardoseală dreaptă. La montarea la perete utilizați întotdeauna material de fixare adecvat.

ES

El montaje debe efectuarse sobre una superficie uniforme. En el montaje mural emplee siempre el material de fijación adecuado.



D CH AT LI LU

Zur Möbelreinigung ein mit Wasser befeuchtetes, fusselfreies Baumwolltuch verwenden. Gereinigte Flächen immer trockenreiben!

GB US

To clean the furniture only use a water dampened lint-free cotton cloth. Once cleaned, always wipe the surfaces dry.

FR BE NC

Utilisez un chiffon en coton non pelucheux humidifié avec de l'eau pour nettoyer les meubles. Séchez systématiquement les surfaces nettoyées en les frottant !

NL

Gebruik een met water bevochtigde, pluivrije katoenen doek om de meubels te reinigen. Wrijf gereinigde oppervlakken altijd droog!

IT

Per pulire il mobile utilizzare un panno di cotone inumidito d'acqua e che non perde pelucchi. Asciugare sempre le superfici che si sono pulite!

SI

Za čiščenje pohištva uporabljajte vlažno bombažno krpo, ki ne pušča vlaken. Očiščene površine vedno obrišite do suhega!

XS HR BA

Za čiščenje namještaja koristite sa vodom navlaženu pamučnu krpu koja ne ispušta vlakna. Očiščene površine uvijek obrišite suhom krpom!

HU

Bútorisztításhoz vízzel benedvesített, nem szálazódó pamutkendőt használjon. A megtisztított felületeket mindig törölje szárazra!

BG

За почистване на мебелите използвайте навлажнена с вода, неизпускаща влакна памучна кърпа. Почистените повърхности винаги да се изтриват до сухо!

CZ SK

K čištění nábytku používejte bavlněný hadr neuvolňující vlákna, navlhčený ve vodě. Vyčištěné plochy vždy utřete do sucha!

PT

Para limpar os móveis, use um pano de algodão que não largue pelo, humedecido com água. Seque sempre bem as superfícies limpas com um pano!

RO

Pentru curățarea mobilei utilizați o lavetă din bumbac fără scame umezită cu apă. Suprafețele curățate se șterg întotdeauna până se usucă!

ES





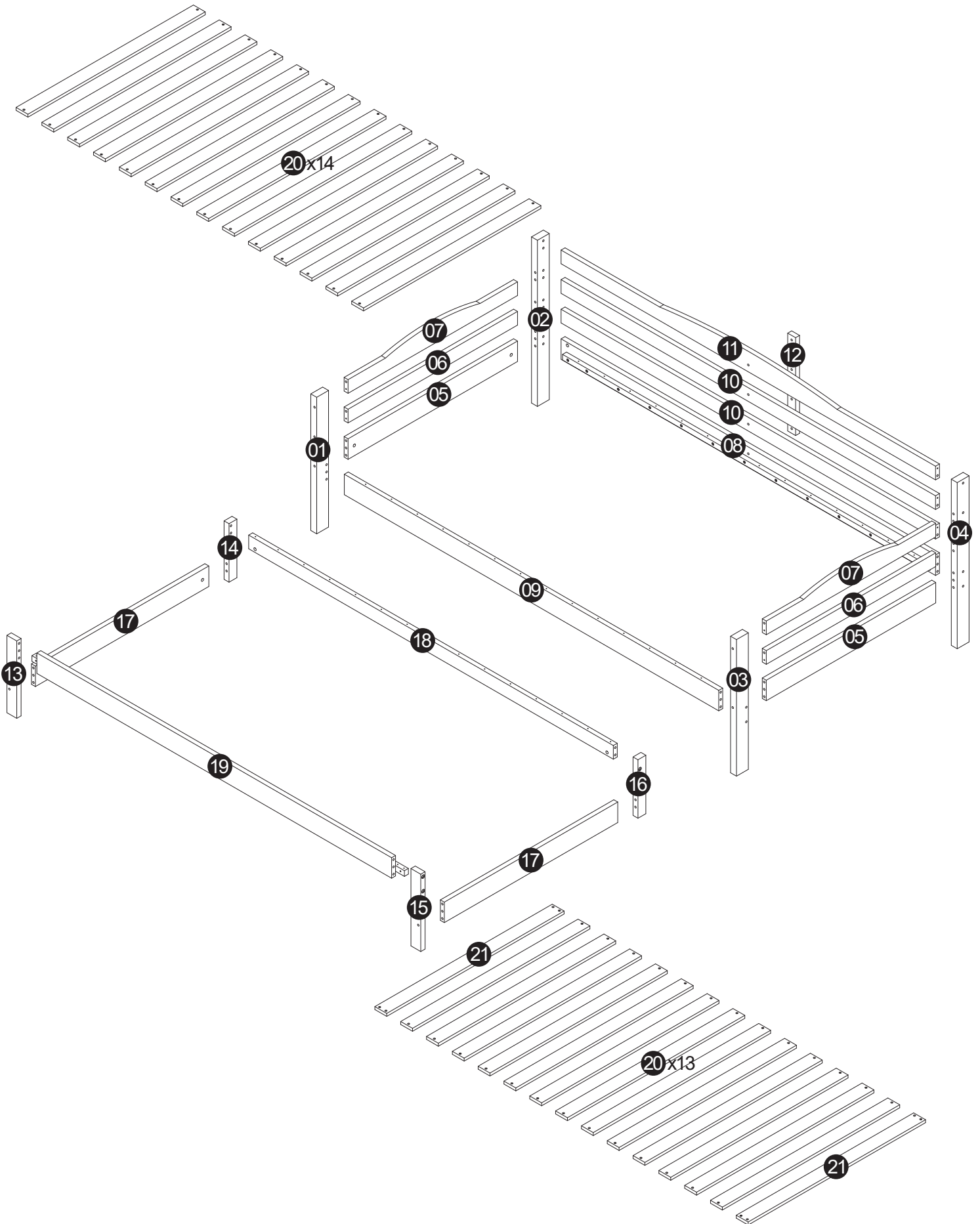

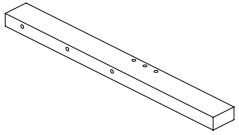
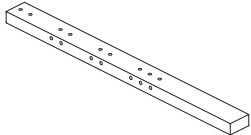
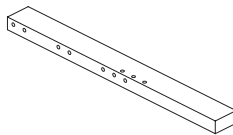
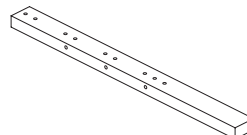
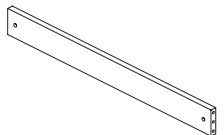
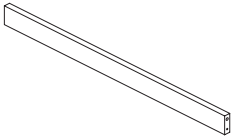
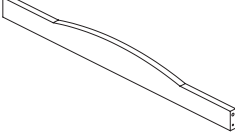
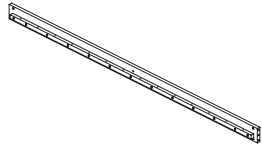
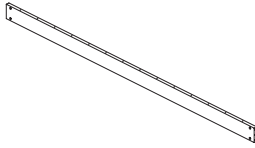
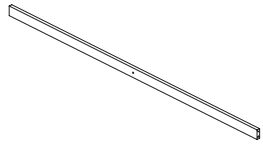
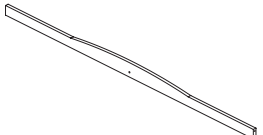
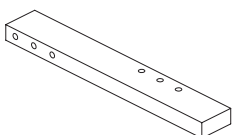
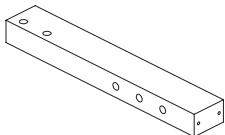
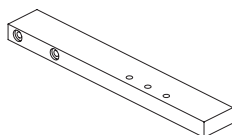
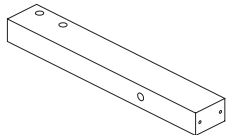
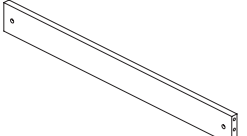
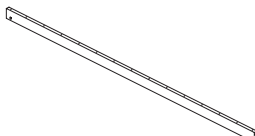
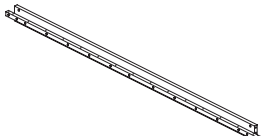

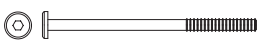

Emplee un paño de algodón humedecido con agua y libre de pelusa para la limpieza de los muebles. ¡Seque siempre las superficies que ha limpiado!

DETAIL VIEW

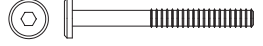
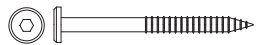
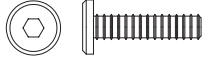

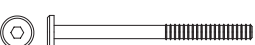
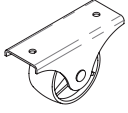
01 x1 	02 x1 	03 x1 	04 x1 	05 x2 
06 x2 	07 x2 	08 x1 	09 x1 	10 x2 
11 x1 	13 x1 	14 x1 	15 x1 	16 x1 
17 x2 	18 x1 	19 x1 		

HARDWARE

A x4  M6x100	B x22 	C x38  Φ8x30	D x8  Φ6x100	E x12  M6x70
F x6  Φ6x70	G x4  M6x30	H x4 	J x6  M6x90	K x2 
L x4  Φ3.5x16	M x2  Φ4x30	N x62  Φ3x30	P x2 	

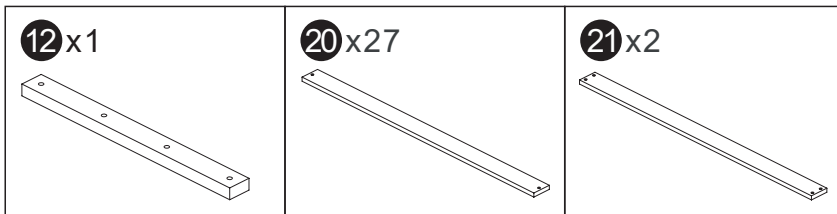

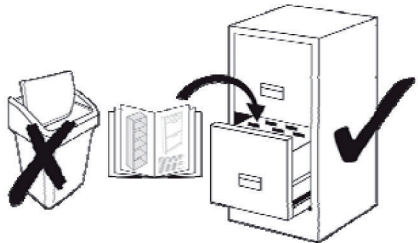
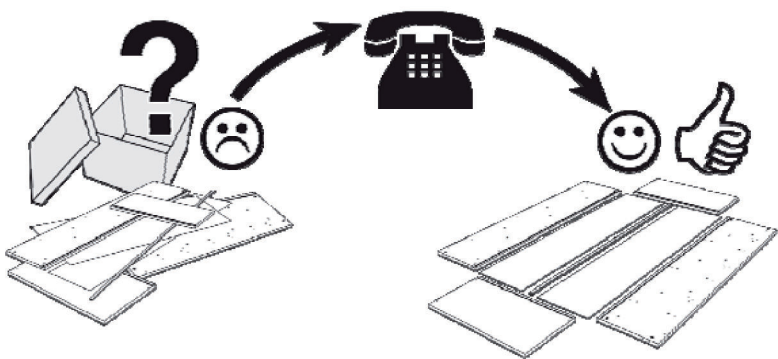
Service • Assistenza • Dienstverlening • Serwis Servis • Szerviz • Сервисная служба	
Name • Nom • Nome • Naam Nazwa • Jméno • Názov • Név Denumire • Ísim • Название	
Nr. • No. • N° • Номер • Č • Sz	
Тур • Туре • Tip • Típus • Tipo Тип	
	
	

Step 1

C



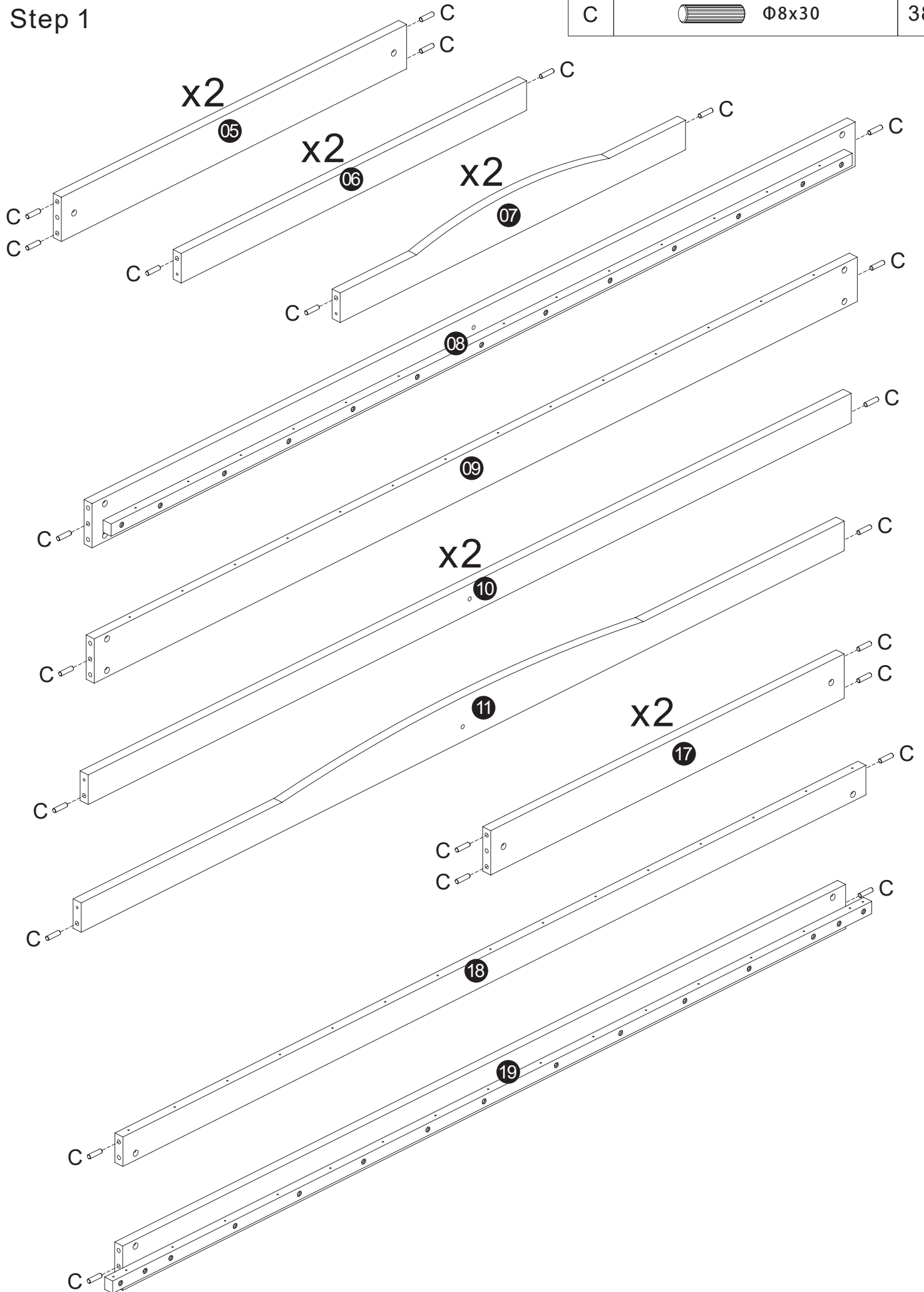

Φ8x30

38



Step 2

A		M6x100	4
---	--	--------	---

B			4
---	--	--	---

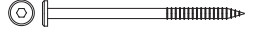
D		Φ6x100	8
---	---	--------	---

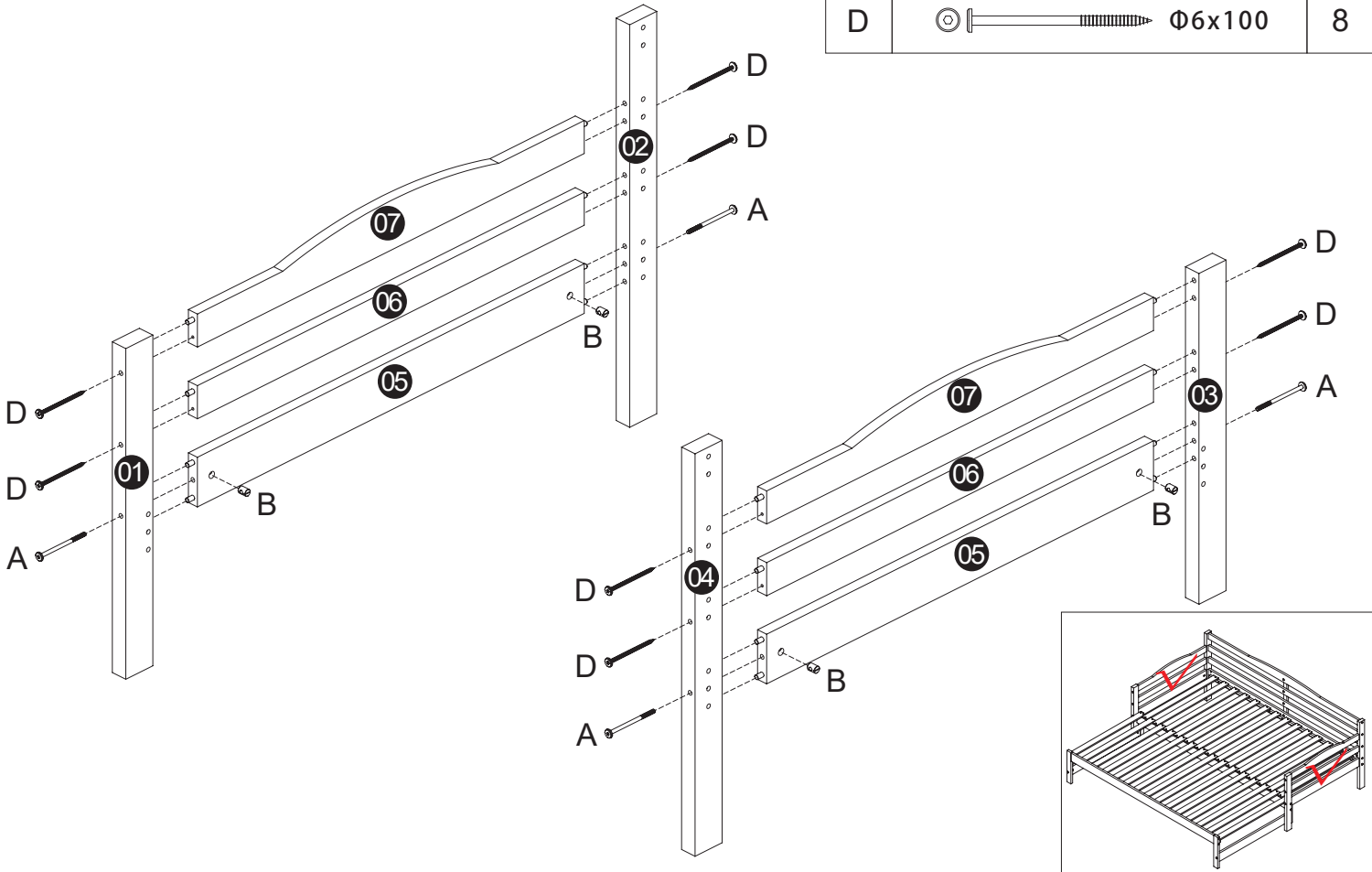

Step 3



B			8
---	---	--	---

E		M6x70	8
---	---	-------	---

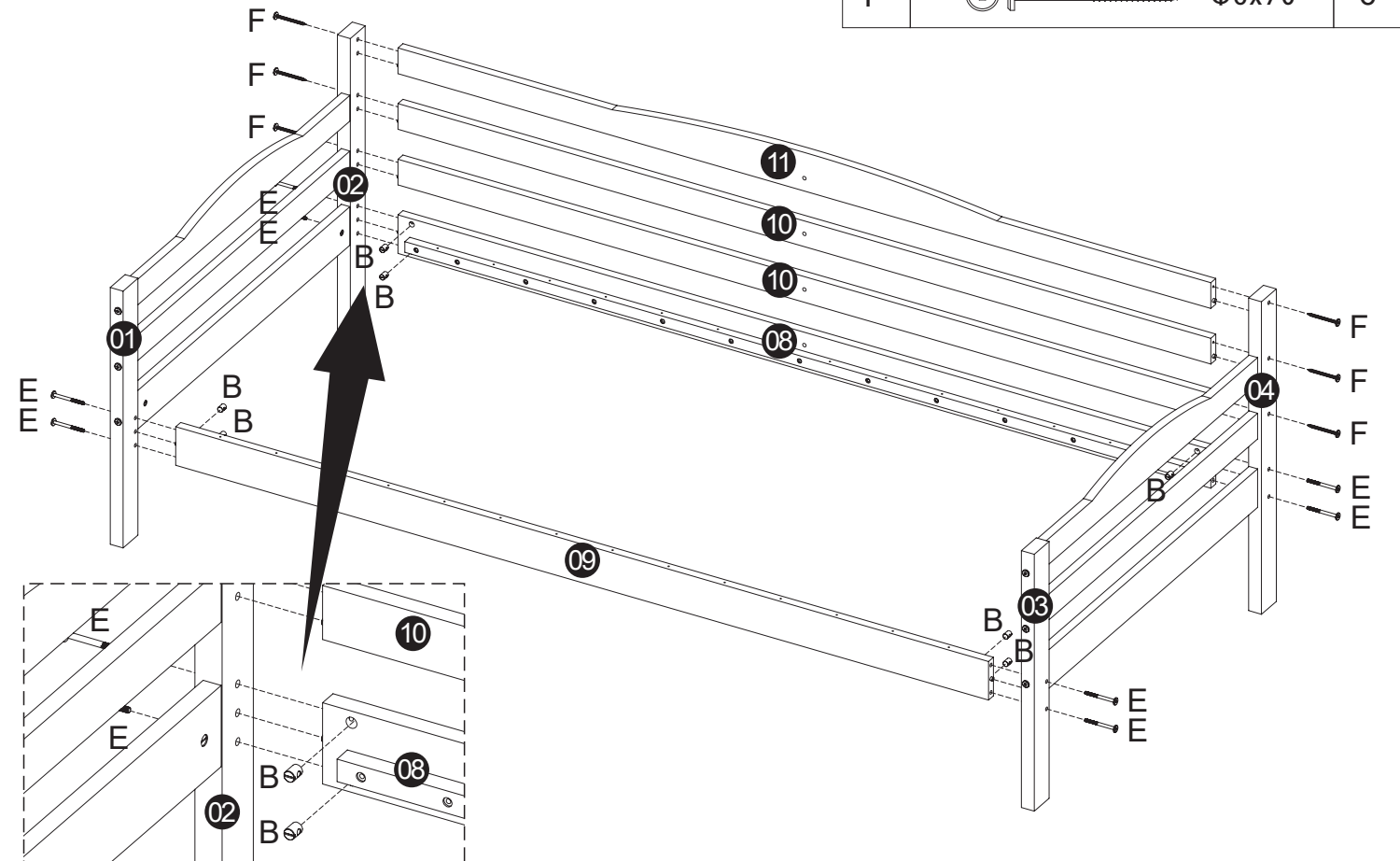
F		Φ6x70	6
---	---	-------	---





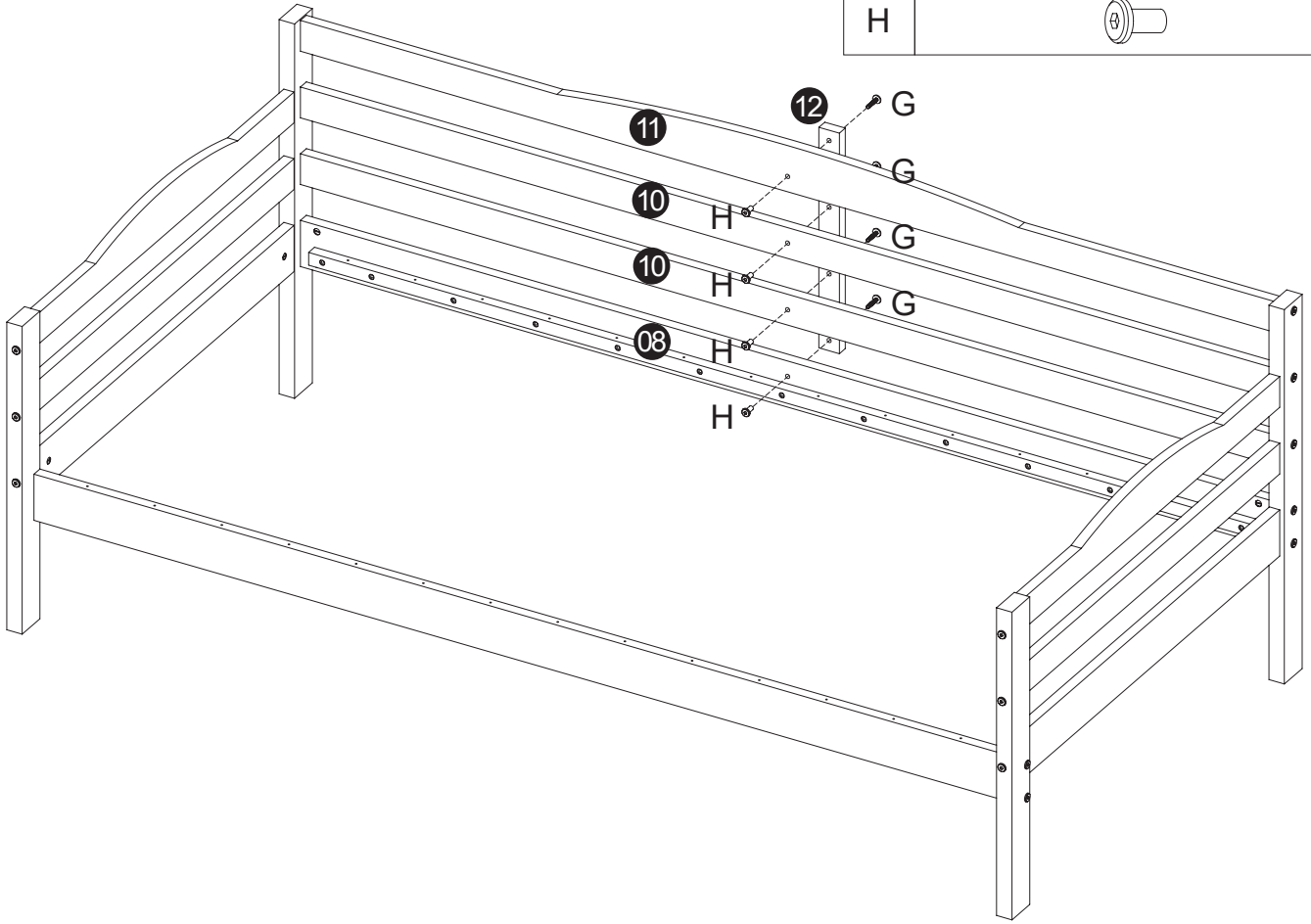

Step 4

G	 M6x30	4
H		4





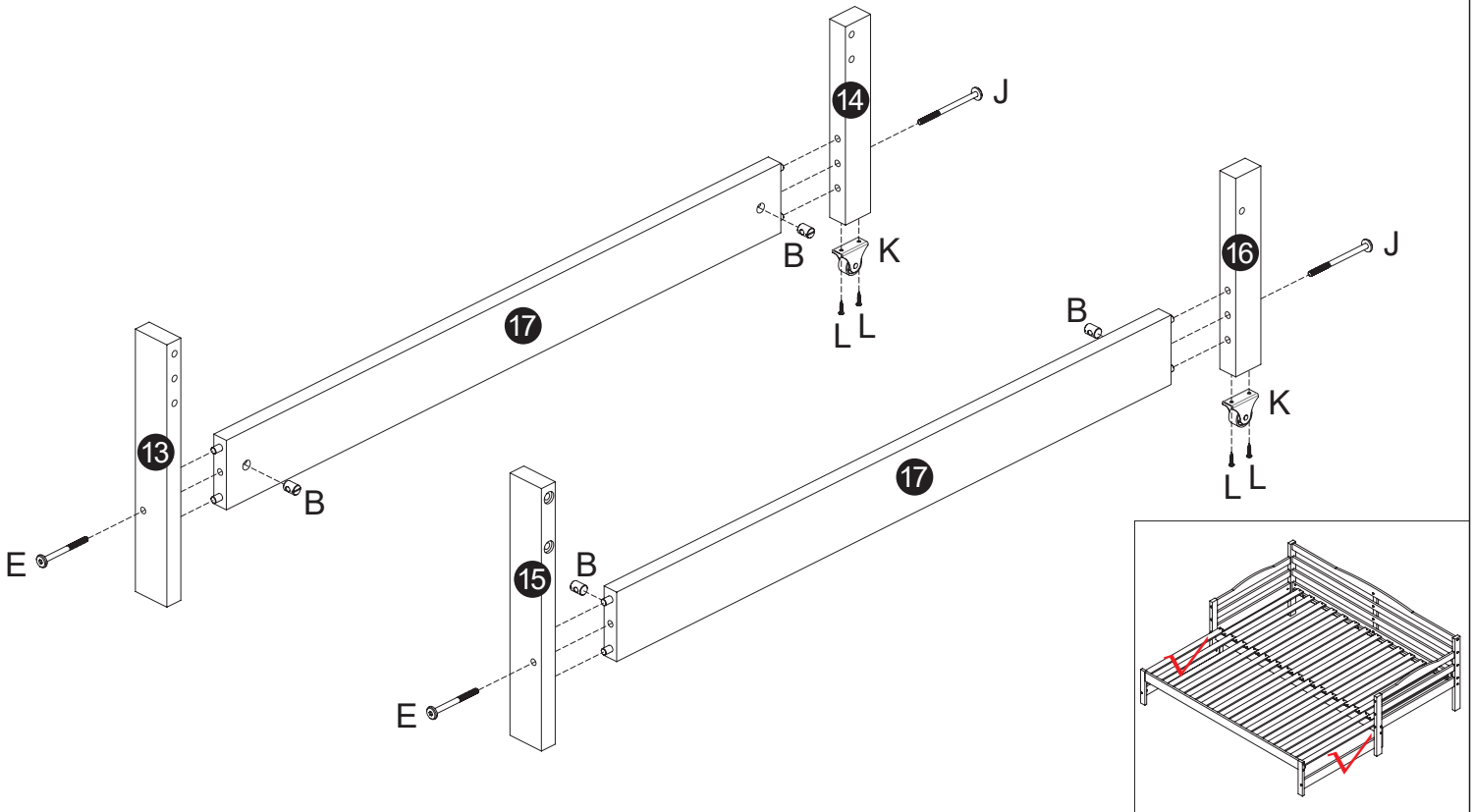

Step 5

B		4	J	 M6x90	2
E	 M6x70	2	K		2
			L	 $\Phi 3.5 \times 16$	4



Step 6

B		6	J	 M6x90	4
E	 M6x70	2	M	 $\Phi 4 \times 30$	2

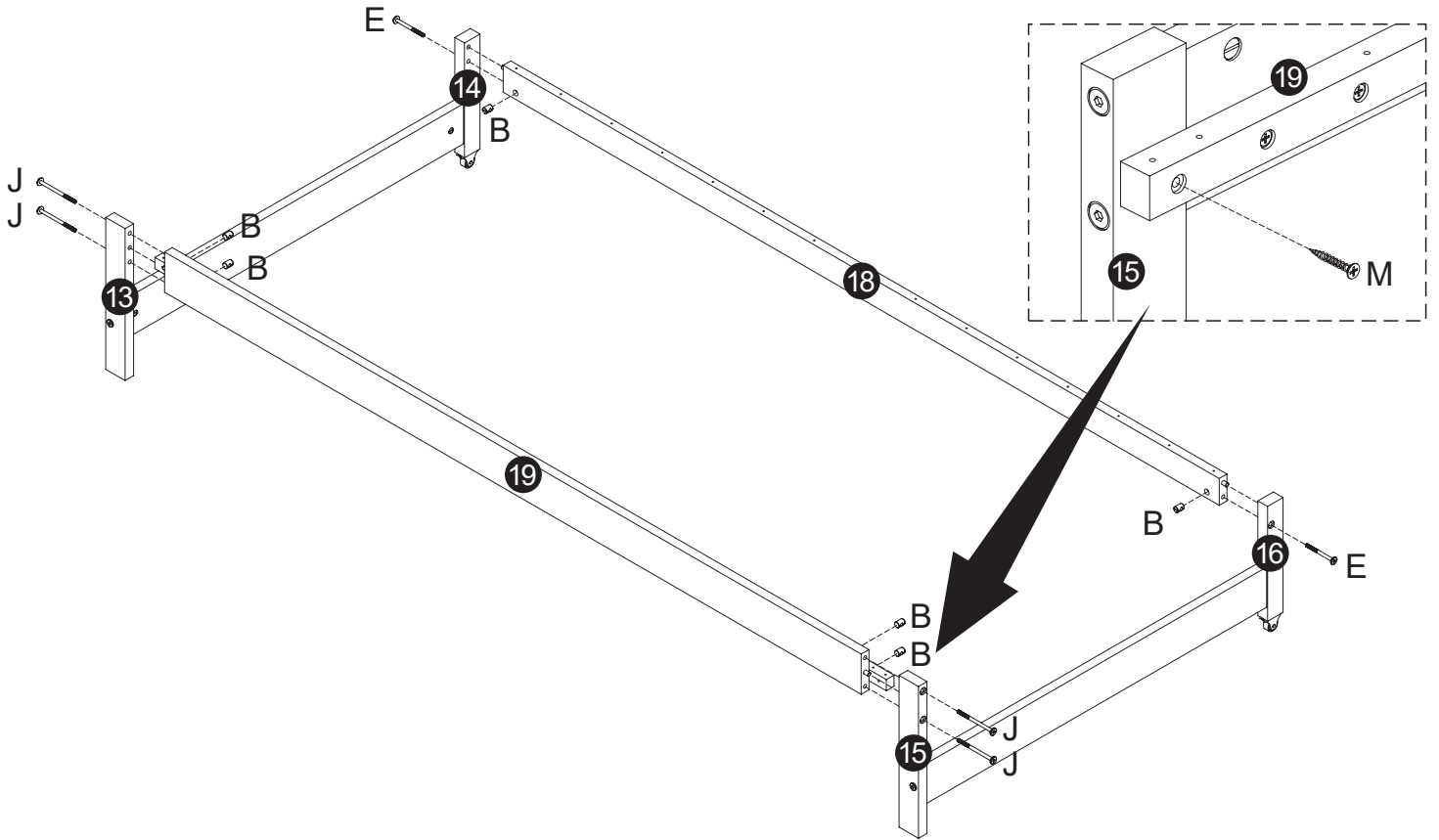

Step 7

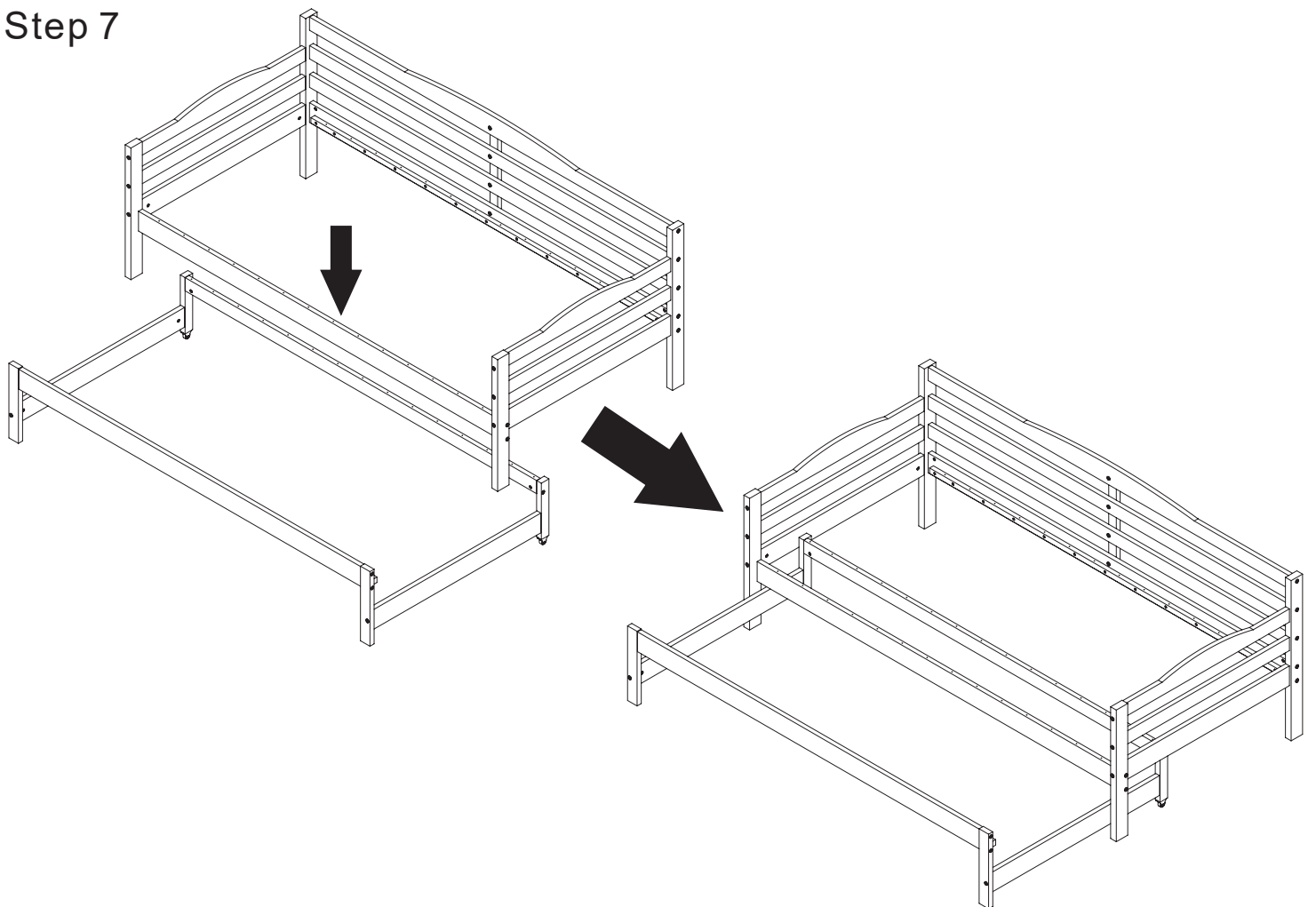

Step 8

N



Ø3x30

28

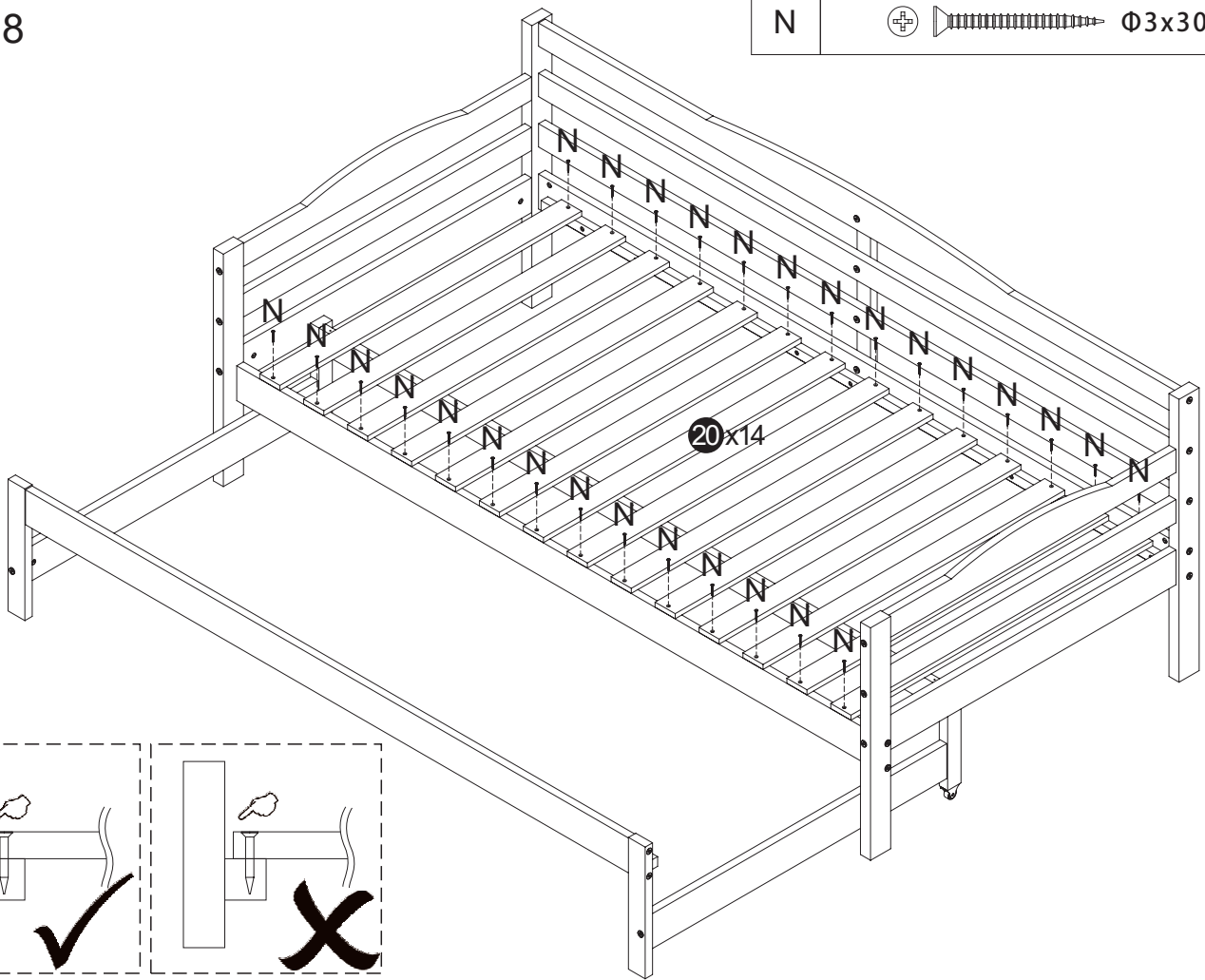

Step 9

N



Ø3x30

34

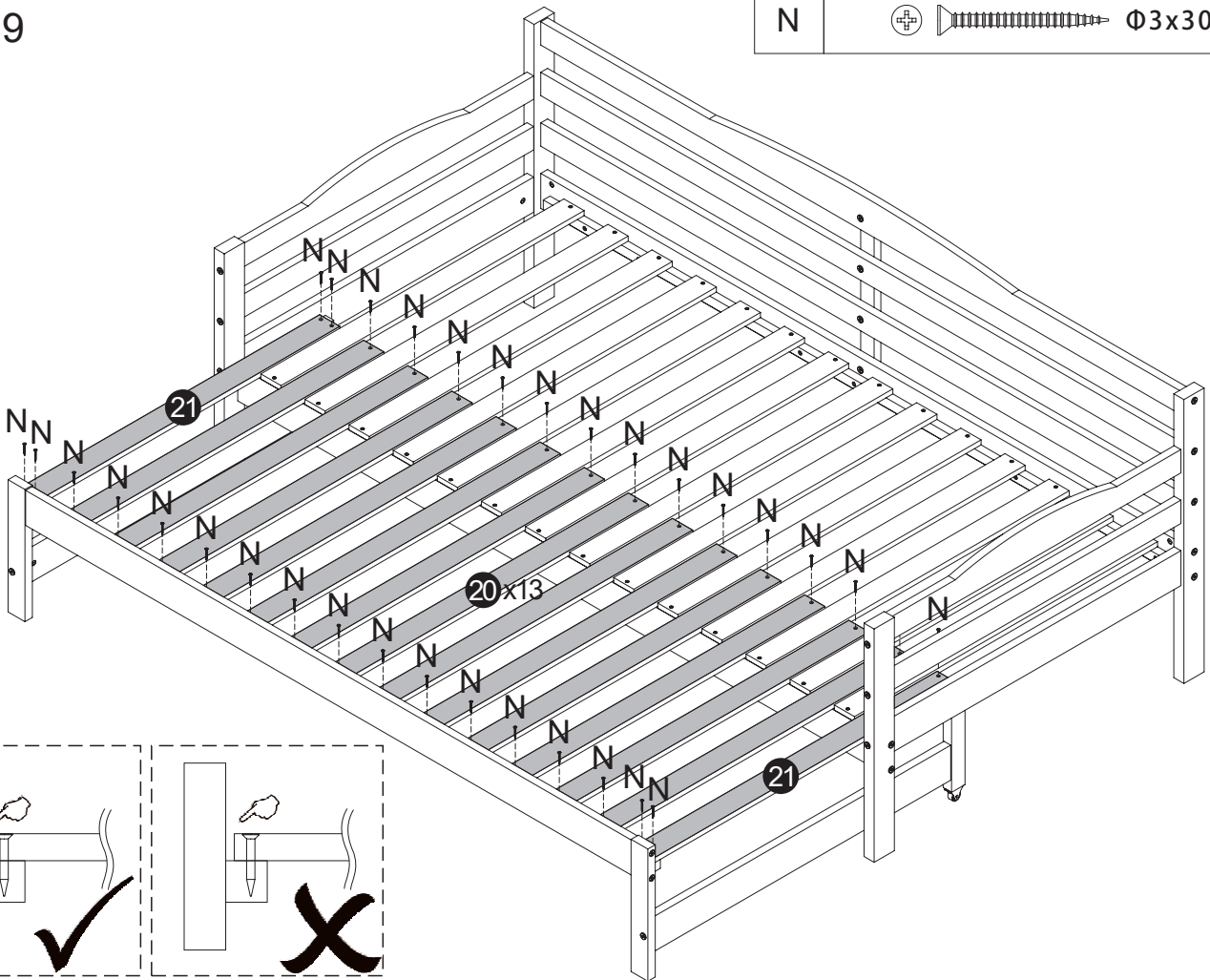

Step 10

