

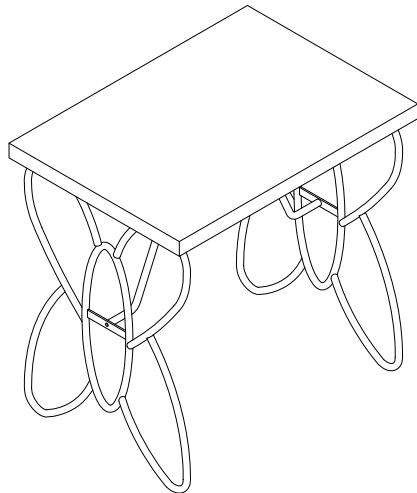

# ASSEMBLY INSTRUCTION

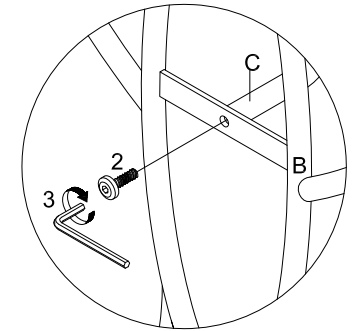
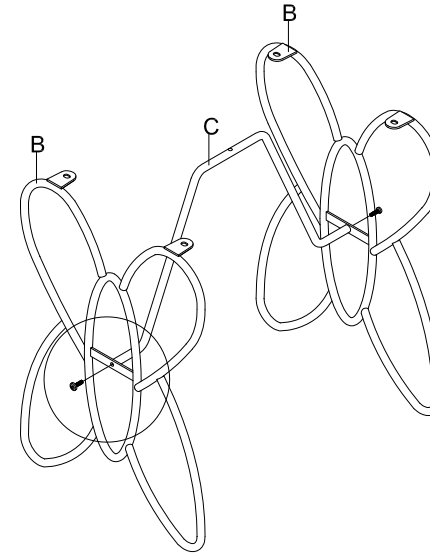

**Do not tighten screws until completely assembled.**

## STEP 1.



2		2pcs
M6x20		



## PARTS IDENTIFICATION

## HARDWARE LIST

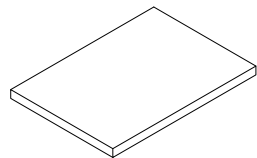
A



1pc

1		4pcs
M6x10		
2		3pcs
M6x20		
3		1pc
4x4		

B

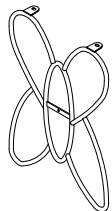

2pcs

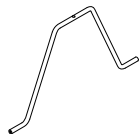

C

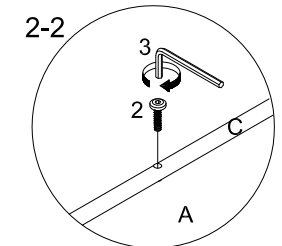
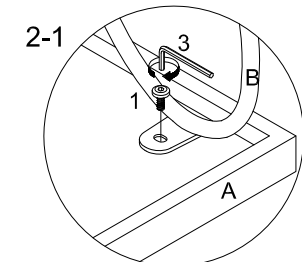
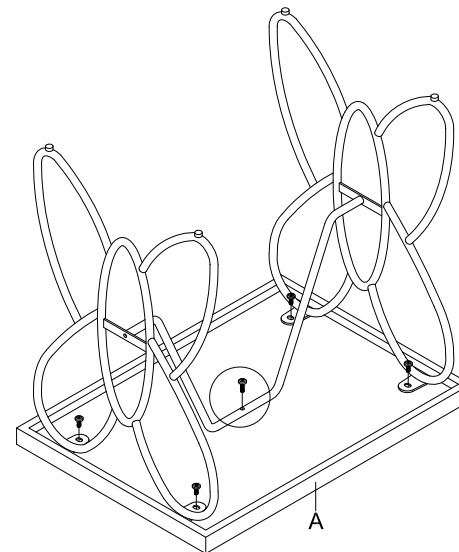

1pc

## STEP 2.



1		4pcs
M6x10		
2		1pc
M6x20		