







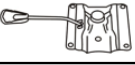

CARE AND MAINTENANCE

Wipe clean with a soft, dry cloth. The seat board can be cleaned with a mild cleaner. Test the cleaning method on a hidden area before using them over the entire area .

NOTICE

- * Please make sure that you have all parts indicated before you begin assembly of this item
- * This item should be assembled on a soft surface to prevent scratching the finish during assembly
- * This item may require periodic tightening

Part List and Hardware List

PIECE	DESCRIPTION	PICTURE	QUANTITY
(1)	Back Cushion+Seat Cushion		1X
(2)	Control Mechanism		1X
(3)	Cylinder Column		1X
(4)	Bellows		1X
(5)	Star Base		1X
(6)	Caster		5X
(7)	Screw		4X
(8)	Washer		4X
(9)	Allen Wrench		1X

Product Dimensions: 18.1"W*22.4"D*32.5~36.2"H



PREPARATION

Before beginning assembly of product, make sure all parts are present. Compare parts with package contents list and hardware contents list.

If any part is missing or damaged, do not attempt to assemble the product.

Estimated Assembly Time: 10 minutes.

Tools Required for Assembly (included): Allen Wrench

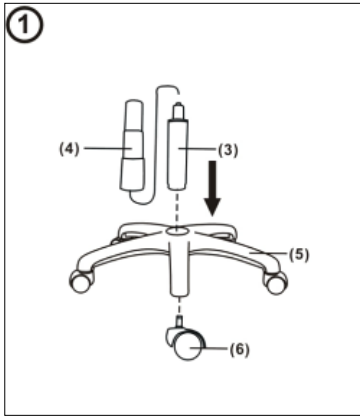

Step 1

Insert five Casters (6) into Star Base (5), push hard until you feel or hear the Caster(6) snap into place. Insert the LARGE end of Cylinder Column (3) with the bellow(4) into the Star Base (5) and carefully press downward with moderate force until it is fully seated.

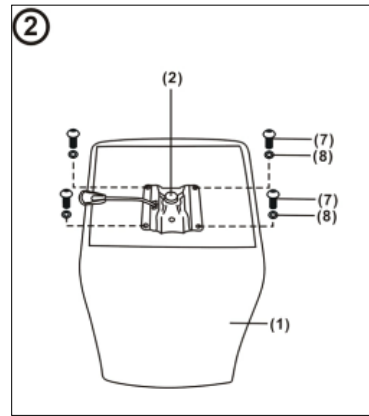

Step 2

Attach Control Mechanism (2) to Seat Assembly (1) with the arrow towards the front of the chair, using four Washers (8) and four Screws(7).

FULLY TIGHTEN ALL SCREWS USING ALLEN WRENCH

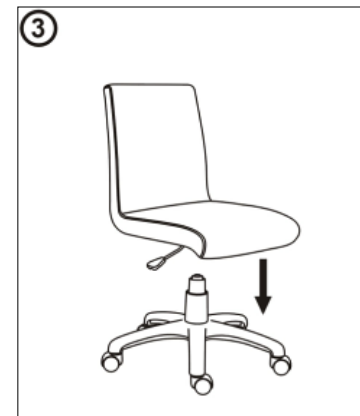

Step 3

Now insert the small end of Cylinder Column (3) into Control Mechanism (2) and carefully press downward with moderate force until it is fully seated.



Step 4

The chair is ok now.

ATTENTION: MAKE SURE ALL SCREWS ARE FULLY TIGHTENED BEFORE USING CHAIR