

Assembly Instructions

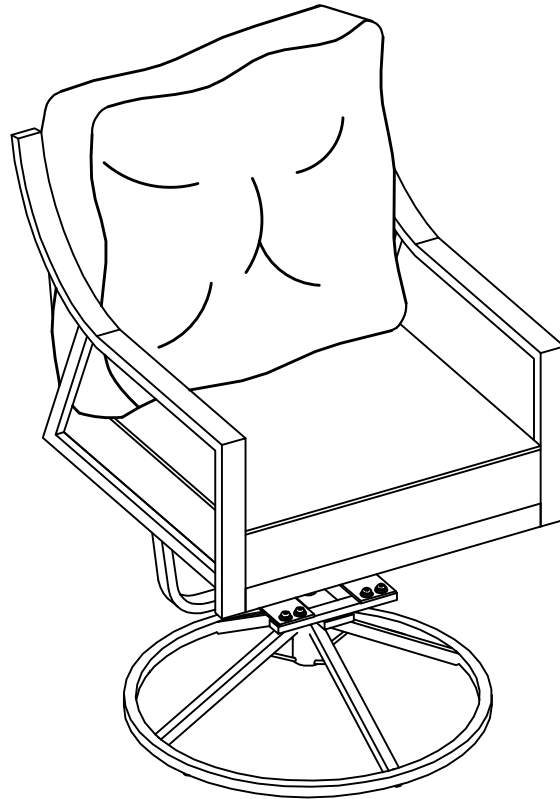

***Don't fully tighten all the bolts till the very end!**

PRE-ASSEMBLY PREPARATION:

- A cordless drill is recommended for ease of assembly.
- Clear out the space for assembly and lay out all of the parts based on the Parts List, extra room will allow you to easily determine if all the pieces are present.
- Keep small parts and pieces away from children until fully assembled.



A1

Left
arm
1 pc

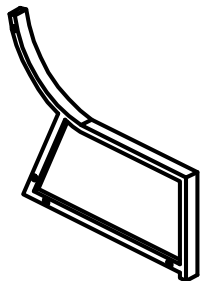

C

Seat
1 pc

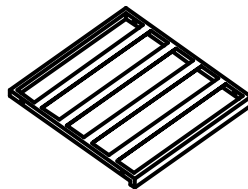

F

Base
1 pc

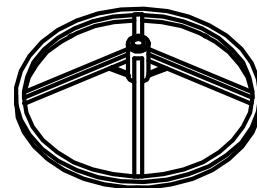

A2

Right
arm
1 pc

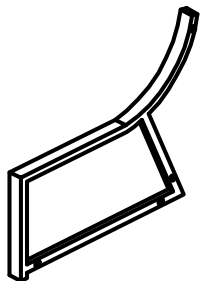

D

U-shape
fitting
1 pc

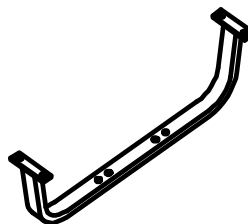

R

Seat
cushion
1 pc

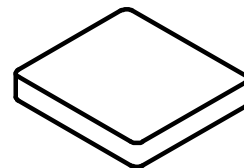

B

Back
1 pc

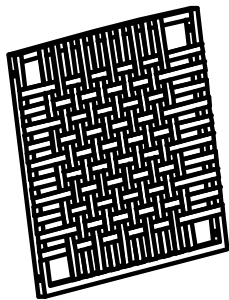

E



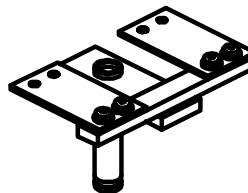

Support
bar
1 pc

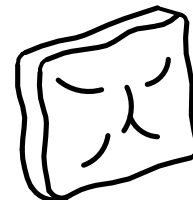

S

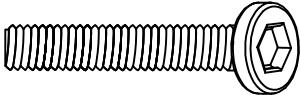
Back
cushion
1 pc

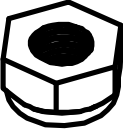
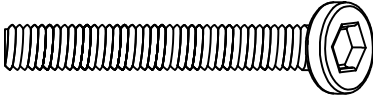
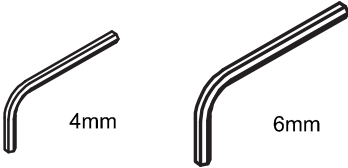

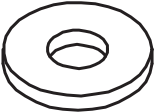
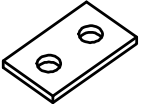

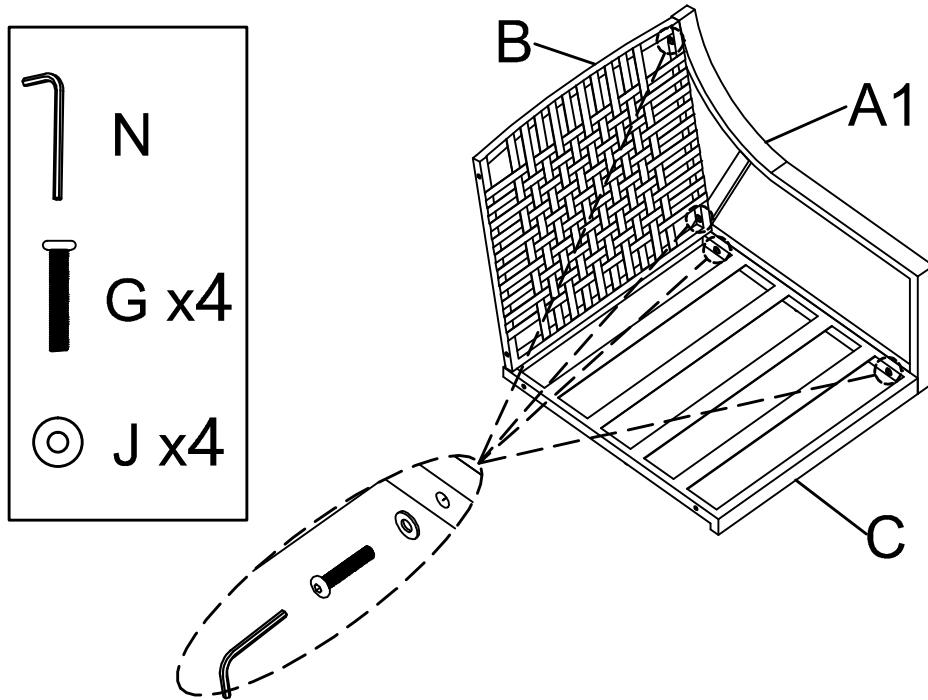

No.	Part/Size	QTY	Image	No.	Part/Size	QTY	Image
G	Bolt (M6*30mm)	8		L	Spring Washer	12	
H	Bolt (M6*20mm)	4		M	Nut	4	
I	Bolt (M6*40mm)	4		N O	Allen wrench	2	
J	Washer	8	 Small Washer	P	Wrench	1	
K	Washer	12	 Big Washer	Q	Washer	2	

Step 1: Attach Back B and Seat C to left arm A1 with 4 pcs bolt G and 4pcs washer J.
using Allen wrench N.

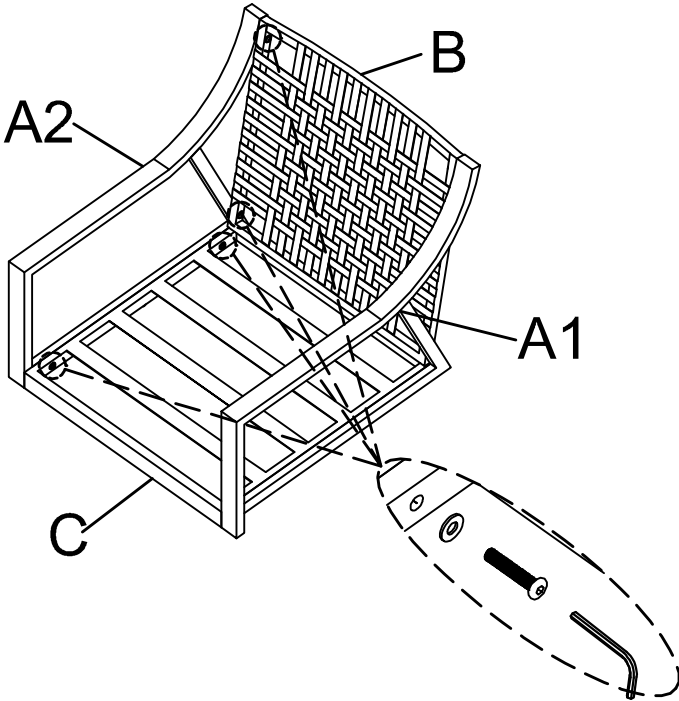

Step 2: Attach Back B and Seat C to arms A2 with 4 pcs bolt G and 4pcs washer J.
using Allen wrench N.



-  N
-  G x4
-  J x4

Step 3: Attach Support bar E to Base F.

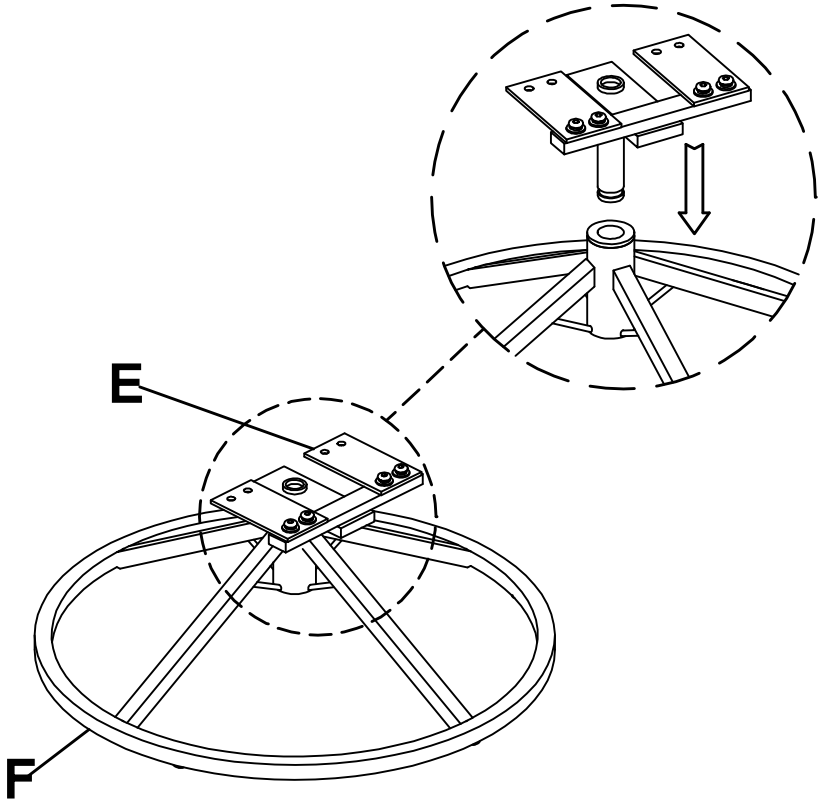

Step 4: Attach U-shape fitting D to support bar E with 4pcs bolts I, 8 pcs spring washer L, 8 pcs washer K, 2pcs washer Q, 4 pcs Nut M, using Allen wrench O and Wrench P.

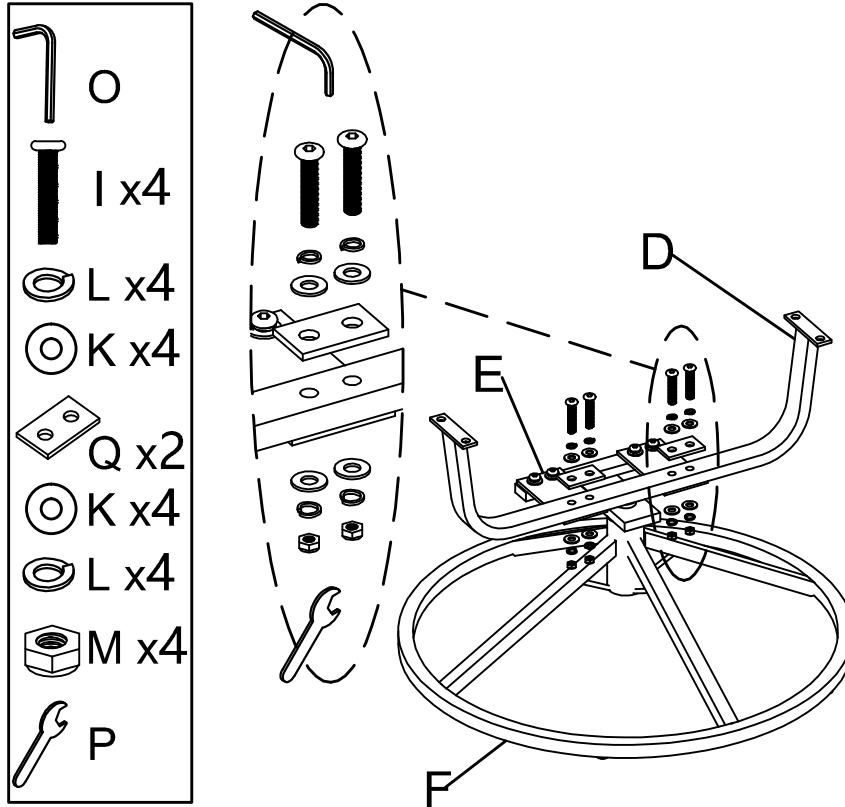

Step 5: Attach F&D to arms A1&A2, with 4pcs bolts H,4pcs spring washer L, 4pcs washer K,using Allen wrench O.

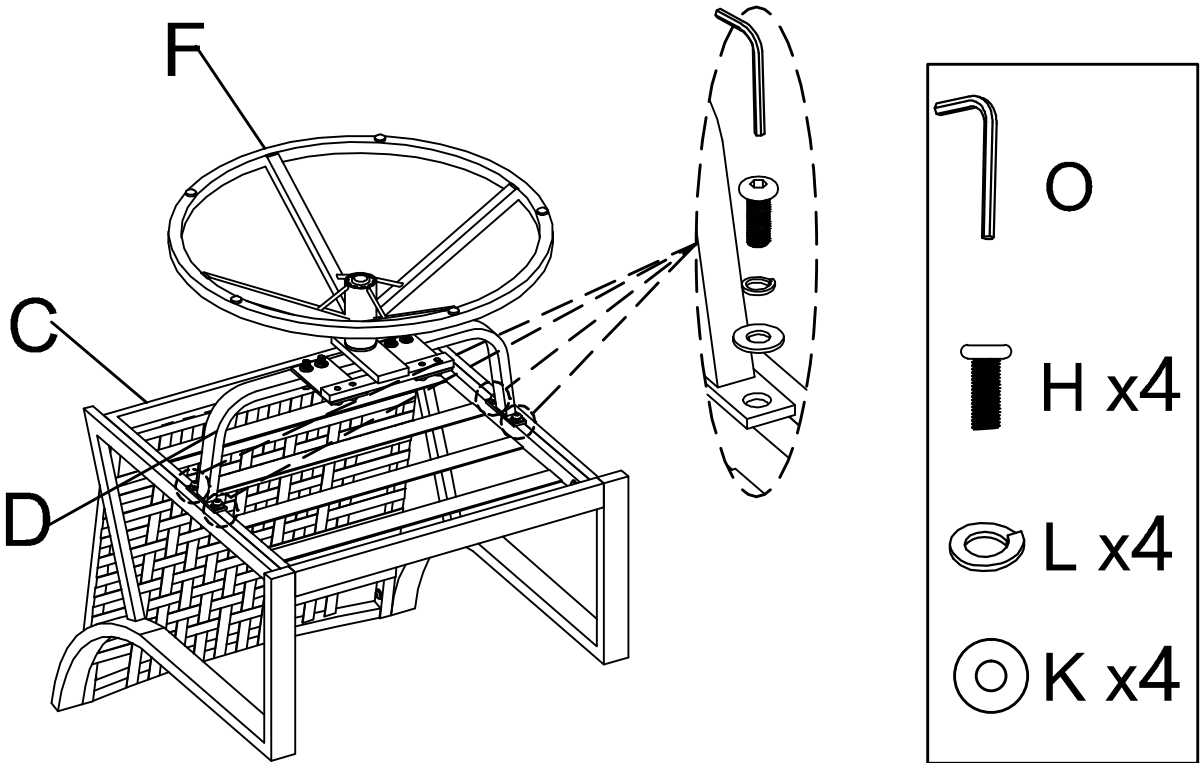

Step 6: Pattention direction.

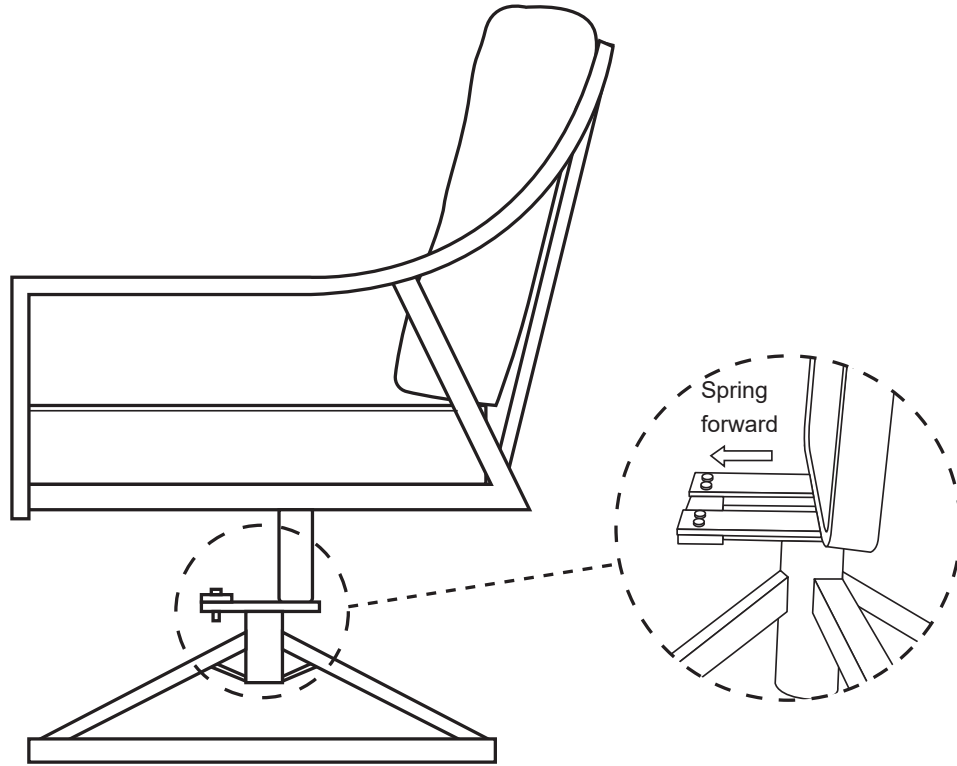

Step 7: Put back cushion S and seat cushion R onto the seat .Assembly is now complete and the product is ready for use.

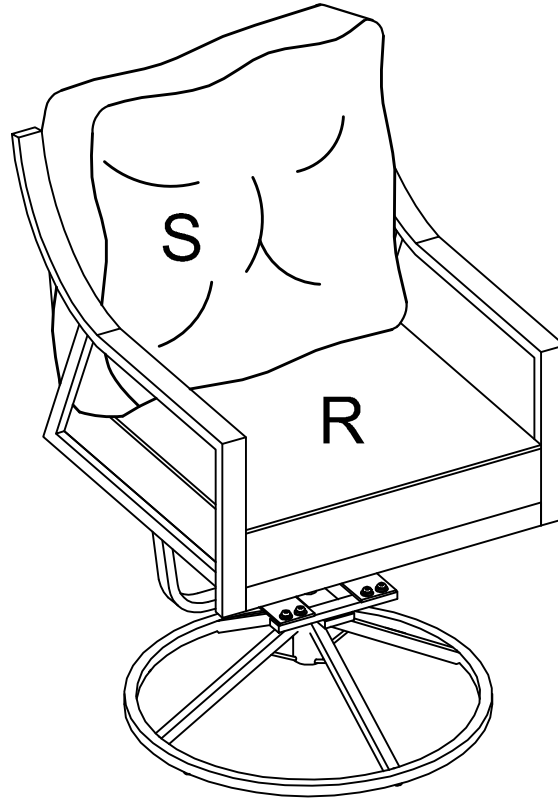

Q & A:

Q: Frame drilling holes not align?

A: If discrepancy less than 1/8 in., please loosen other relative bolts first, then adjust parts position and re-tight all bolts.

if discrepancy more than 1/4 in., it should be parts deformation during violent transportation, please contact us for parts replacement.

Q: Why cushion shrink packing and how to help it rebound faster?

A: We shrink packing cushion is to improve product value to cost, because it can save transport cost a lot. We filled it with more and high-quality filling than normal cushion to make sure it can be fully rebound. Following up this method to speed up rebounding.

Q: Coffee table legs un-even?

A: Loosen bolts, then press table downwards, then tighten bolts again. If it can not solve problem, please contact us for parts replacement.

Q: Wicker colors different on parts?

A: We make wicker stripes to fit for nature environment, colors may various circularly. So when those wicker stripes hand-woven on product randomly, it may looks different on parts.

Q: Why some swivel plate not work well?

A: Swivel plate may need a running-in period like 10~20 cycles. If it still not swivel well, please contact us for swivel plate replacement.

Q: Bolts are not long enough for assembly sometimes?

A: Sometimes gaps maybe larger than the bolts to reach out when assembly, please contact us for longer bolts. After all, those parts are woven by hand-made. But after it assembled and all bolts tightened, the gaps will be disappeared, because wicker parts are flexible surface.

Q: Parts received damaged?

A: Although we had already did our best to pack products well, there are also unpredictable transport damages accident happened from time to time. When it happens, please contact our after-sales email, state the order number/which shopping platform it comes from/one of the parcel tracking number, and provide the relevant pictures of the problem, we will immediately provide you with a suitable replacement parcel.

Q:Received item but missing hardware or parts

A:Please contact our after-sales email, state the order number/which shopping platform it comes from/one of the parcel tracking number, and provide the relevant pictures of the problem, we will immediately provide you with a suitable replacement parcel.

How to take care of the product

1. Maintain your outdoor furniture by using furniture covers or storing out of the elements when not in use.

2. Wicker: Wipe surface dust with warm water

3. Frame: Clean frames with a mild soap and warm water, rinse with clean water and dry thoroughly. Do not use abrasive materials or strong detergents

4. Fabric: Clean with mild soap and water. Do not put cushions in dryer.

5. In cold climates, drain any water accumulated inside the frames before storing.