











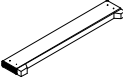
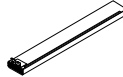

ASSEMBLY INSTRUCTIONS

NOTE: THIS ITEM NOT RECOMMENDED FOR COMMERCIAL USE
 KEEP THIS DOCUMENT FOR REFERENCE IN CASE PARTS ARE NEEDED
 DO NOT TIGHTEN SCREWS UNTIL COMPLETELY ASSEMBLED!!

PARTS LIST

No.	Description	Sketch	Quantity
A	Headboard Panel		1 PC
B	HB Poster (L & R)		2 PCS
C	Footboard		1 PC
D	Side Rail		2 PCS
E	Slats		4 PCS
F	Support Leg		4 PCS

HARDWARE LIST

No.	Description	Sketch	Size	Quantity
1	Flat Washer		5/16"*19*1.5mm	22 PCS
2	Spring Washer		5/16"	22 PCS
3	Allen Bolt		5/16"*1-3/4"	16 PCS
4	Allen Bolt		5/16"*2-1/2"	6 PCS
5	Allen Key		4mm	1 PC
6	Screw		#8x1-3/8"	8 PCS
7	Rectangle Plate		(In Hardware Bag)	2 PCS

Step 1:

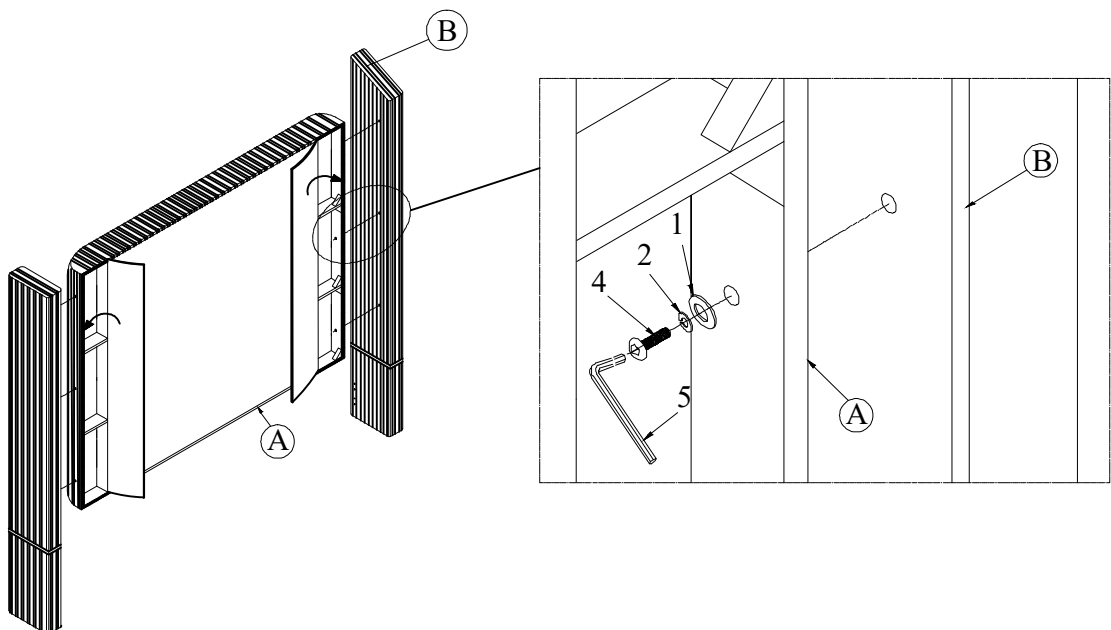

ASSEMBLY INSTRUCTIONS

NOTE: THIS ITEM NOT RECOMMENDED FOR COMMERCIAL USE
KEEP THIS DOCUMENT FOR REFERENCE IN CASE PARTS ARE NEEDED
DO NOT TIGHTEN SCREWS UNTIL COMPLETELY ASSEMBLED!!

Step 2:

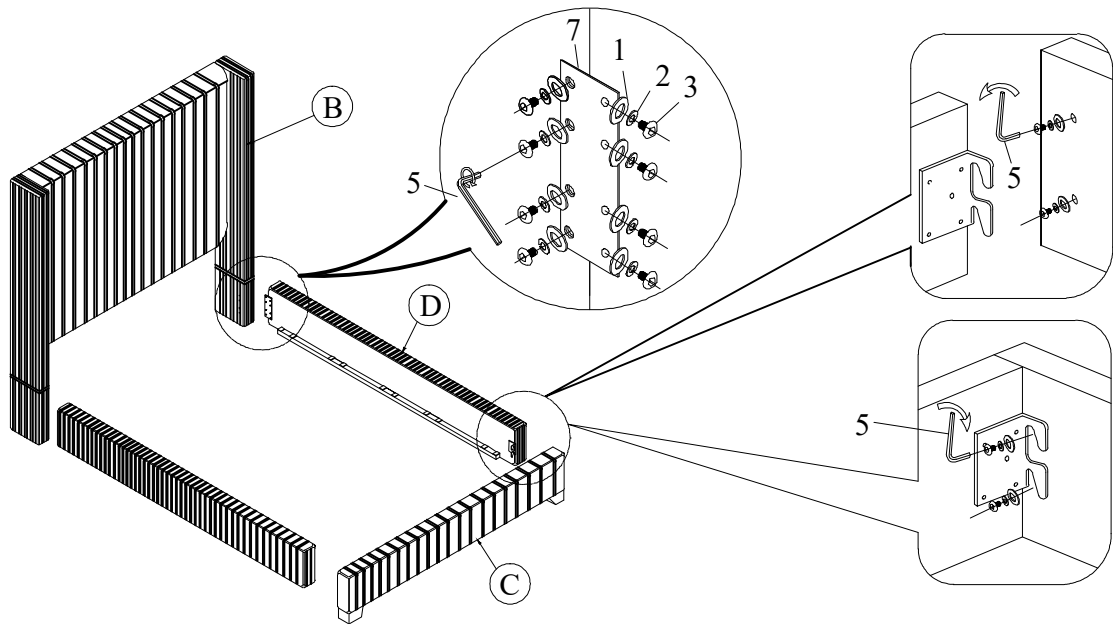

Step 3:

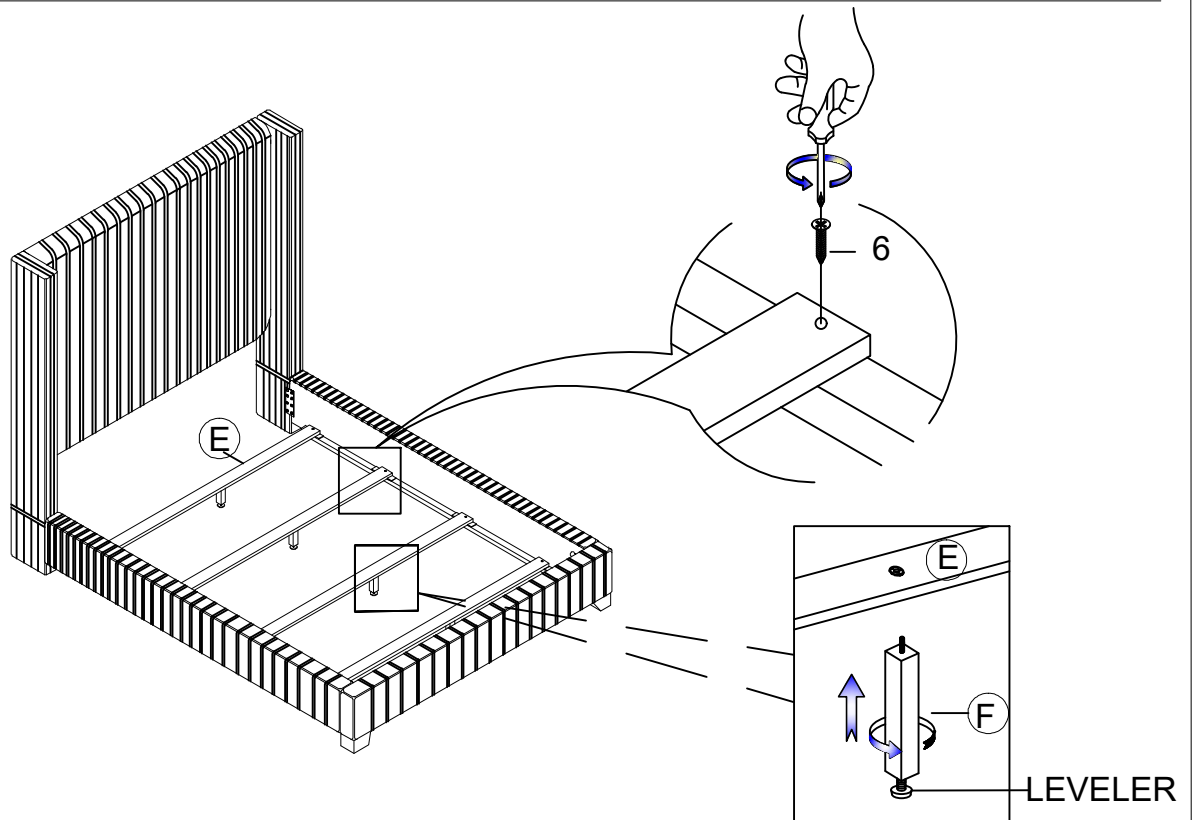

ASSEMBLY INSTRUCTIONS

NOTE: THIS ITEM NOT RECOMMENDED FOR COMMERCIAL USE
KEEP THIS DOCUMENT FOR REFERENCE IN CASE PARTS ARE NEEDED
DO NOT TIGHTEN SCREWS UNTIL COMPLETELY ASSEMBLED!!

Step 4:

