

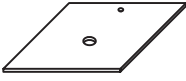











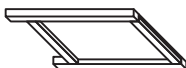

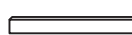
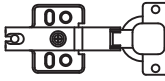

Bathroom Vanity

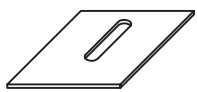
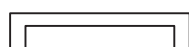
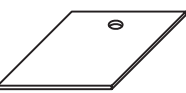



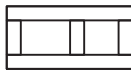

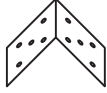
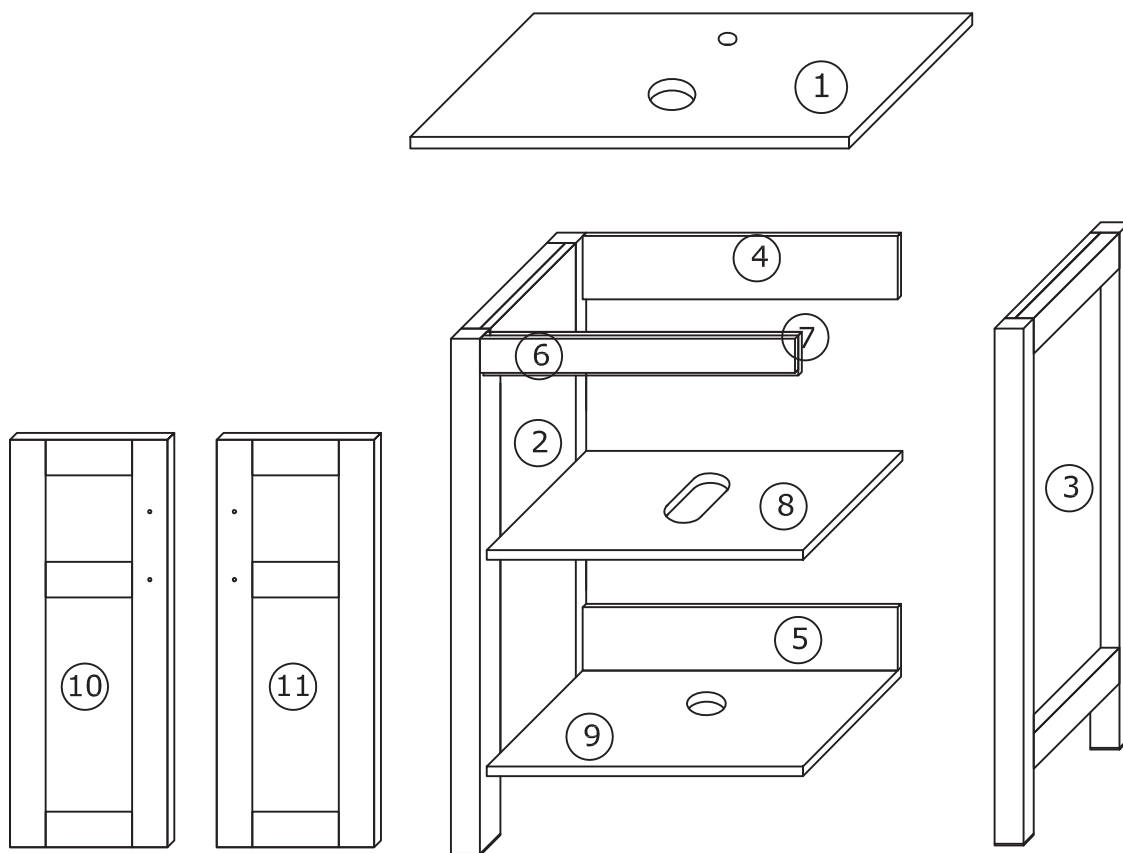





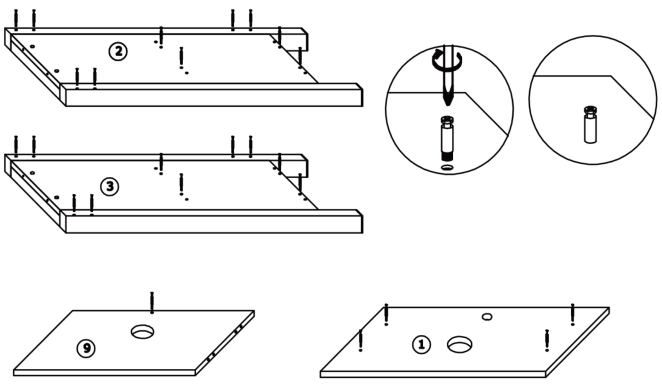



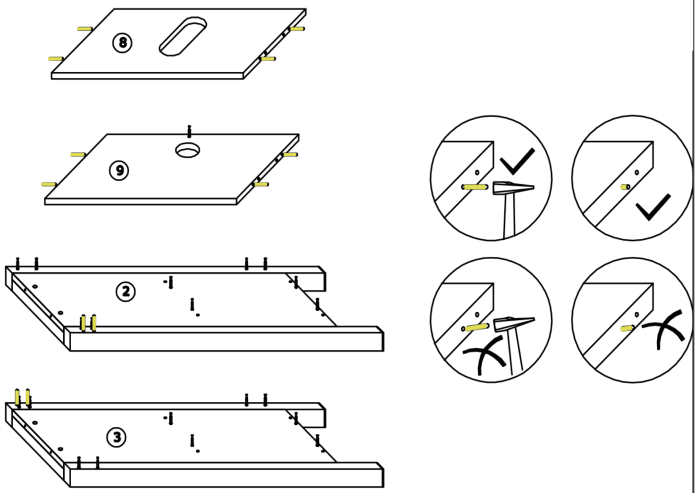







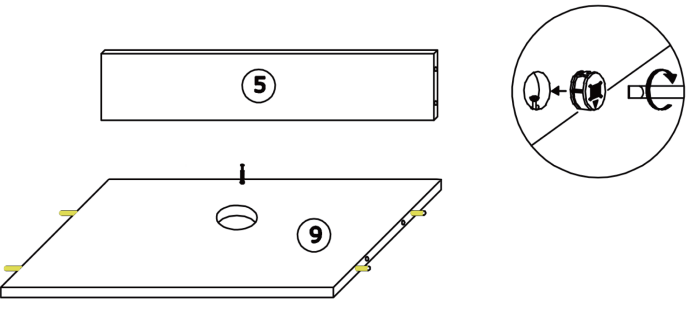

Package list

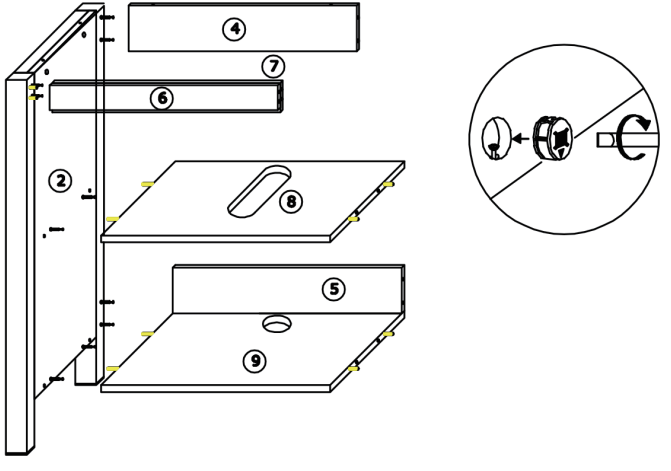
Parts list			Hardware list		
NO.	Description	QTY	NO.	Description	QTY
1		1	A	 CAM LOCK	28
2		1	B	 CAM SCREW	28
3		1			
4		1	D	 WOODEN DOWEL	12
5		1	E	 SCREW	40
6		1	F	 HINGE	4
7		1	G	 HASCREW ($\phi 4 \times 18 \text{MM}$)	4
8		1	H	 HANDLE	2
9		1	I	 $\phi 5 \times 40 \text{MM}$	2
10		1	J	 $\phi 6 \times 30 \text{MM}$	2
11		1	K		4
			L	 CORNER IRON	2



Installation Manual

<p>step1</p> <table border="1" data-bbox="540 355 813 470"> <tr> <th colspan="2">HARDWARE LIST</th> </tr> <tr> <td>B</td> <td> 28PCS</td> </tr> <tr> <td></td> <td></td> </tr> </table> 	HARDWARE LIST		B	 28PCS			<p>step2</p> <table border="1" data-bbox="1258 355 1541 470"> <tr> <th colspan="2">HARDWARE LIST</th> </tr> <tr> <td>D</td> <td> 12PCS</td> </tr> <tr> <td></td> <td></td> </tr> </table> 	HARDWARE LIST		D	 12PCS		
HARDWARE LIST													
B	 28PCS												
													
HARDWARE LIST													
D	 12PCS												
													
<p>step3</p> <table border="1" data-bbox="540 1205 813 1320"> <tr> <th colspan="2">HARDWARE LIST</th> </tr> <tr> <td>A</td> <td> 2PCS</td> </tr> <tr> <td></td> <td></td> </tr> </table> 	HARDWARE LIST		A	 2PCS			<p>step4</p> <table border="1" data-bbox="1258 1205 1541 1320"> <tr> <th colspan="2">HARDWARE LIST</th> </tr> <tr> <td>A</td> <td> 10PCS</td> </tr> <tr> <td></td> <td></td> </tr> </table> 	HARDWARE LIST		A	 10PCS		
HARDWARE LIST													
A	 2PCS												
													
HARDWARE LIST													
A	 10PCS												
													

Installation Manual

step5

HARDWARE LIST	
A	10PCS

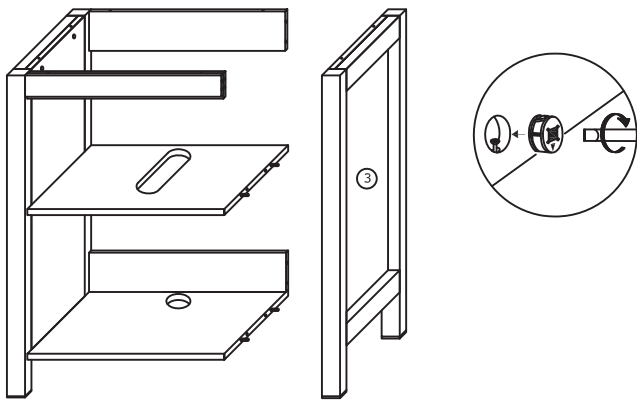
step6

HARDWARE LIST	
A	6PCS
L	2PCS
E	16PCS

step7

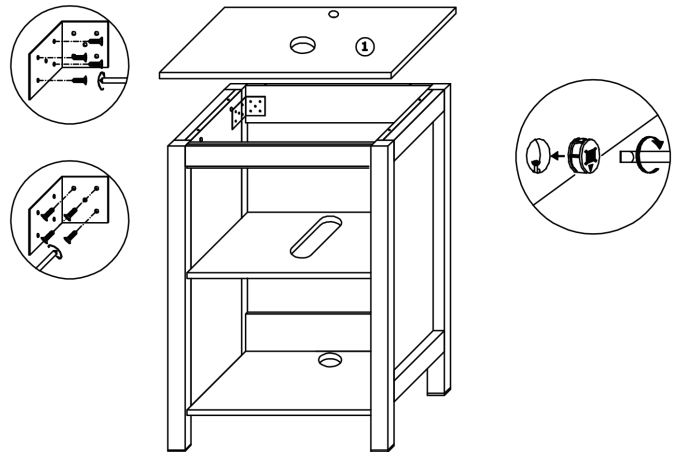
HARDWARE LIST	
E	8PCS
F	4PCS

step8

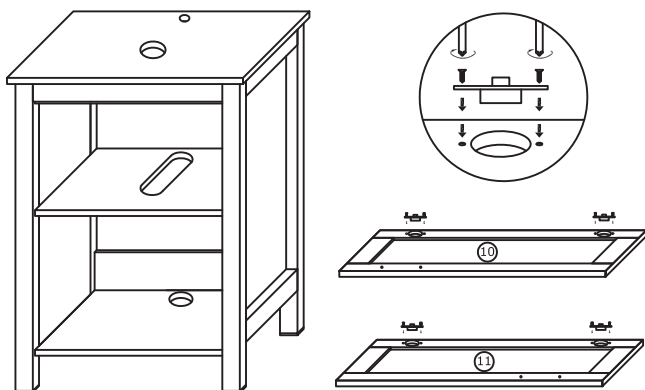
HARDWARE LIST	
E	16PCS
G	4PCS
H	2PCS

Installation Manual

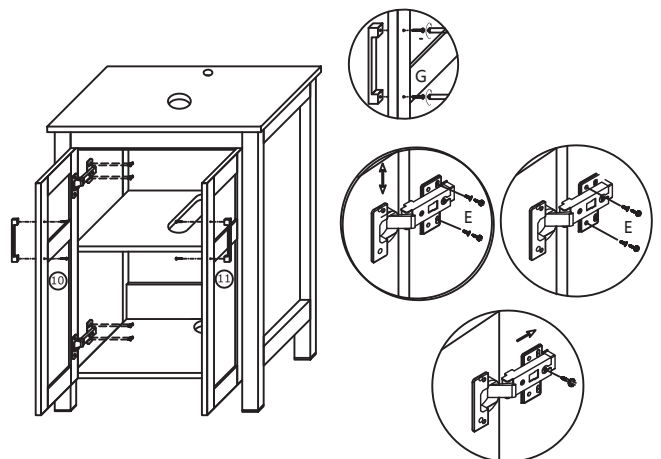
step9

A. height adjustment:

B. depth adjustment:

C. side to side adjustment:

HARDWARE LIST

k	
---	---

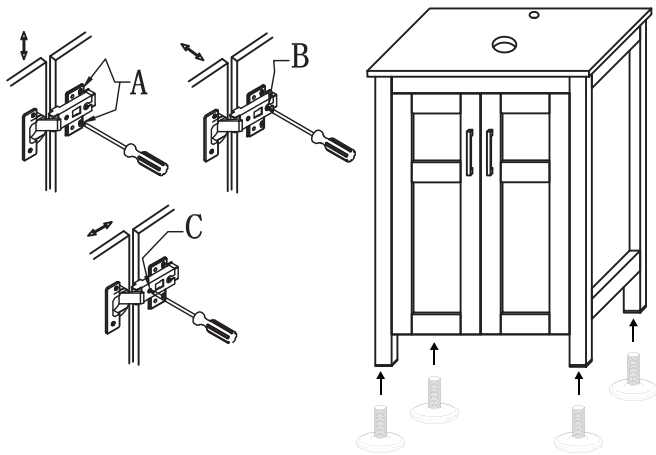

step10

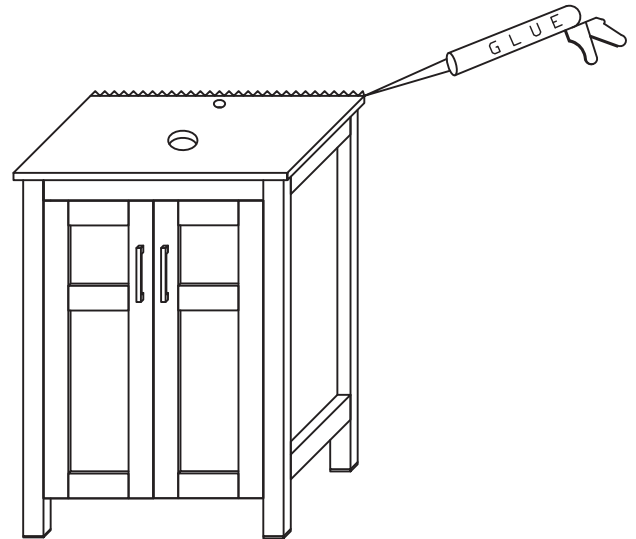

Installation Manual

Please follow the instructions below for ceramic vessel suit if the vessel is needed (Vessel Sink Combo sold separately):

1. Undo step 6 to remove vanity top board #1;
2. Please compare with the picture below and follow the instruction manual to assemble ceramic vessel;

