

ASSEMBLY INSTRUCTIONS

2-SEAT BENCH

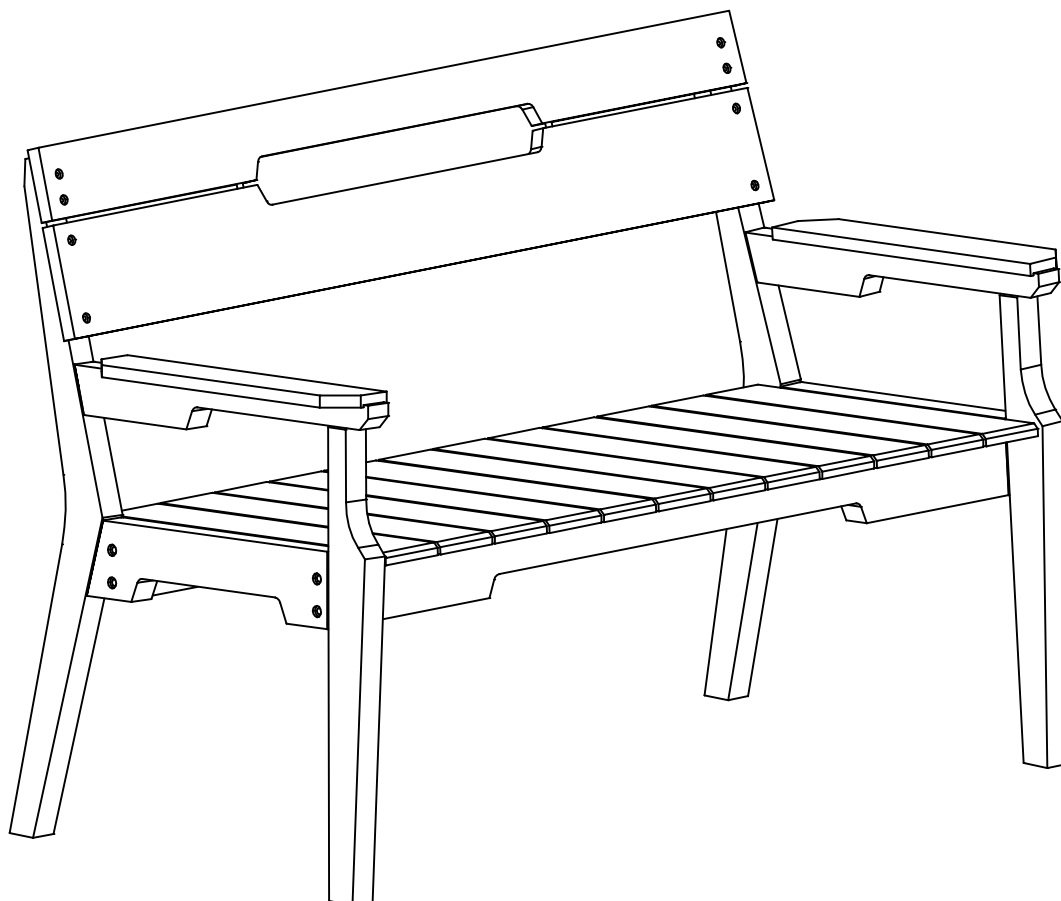

Tools Required (Not Included)

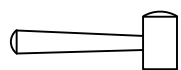

Rubber Hammer



Phillips Screwdriver

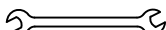

Wrench



Cordless Drive (*)

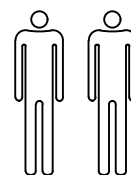

(*) NOTE: Optional - use in place of hex drive.

Identifying the Hardware-Identify the hardware using the illustrations below.

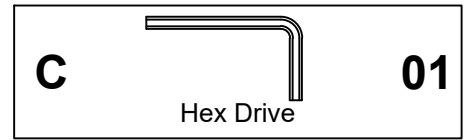
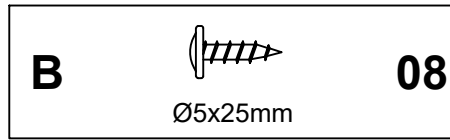
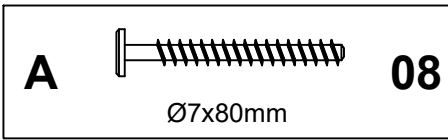

01

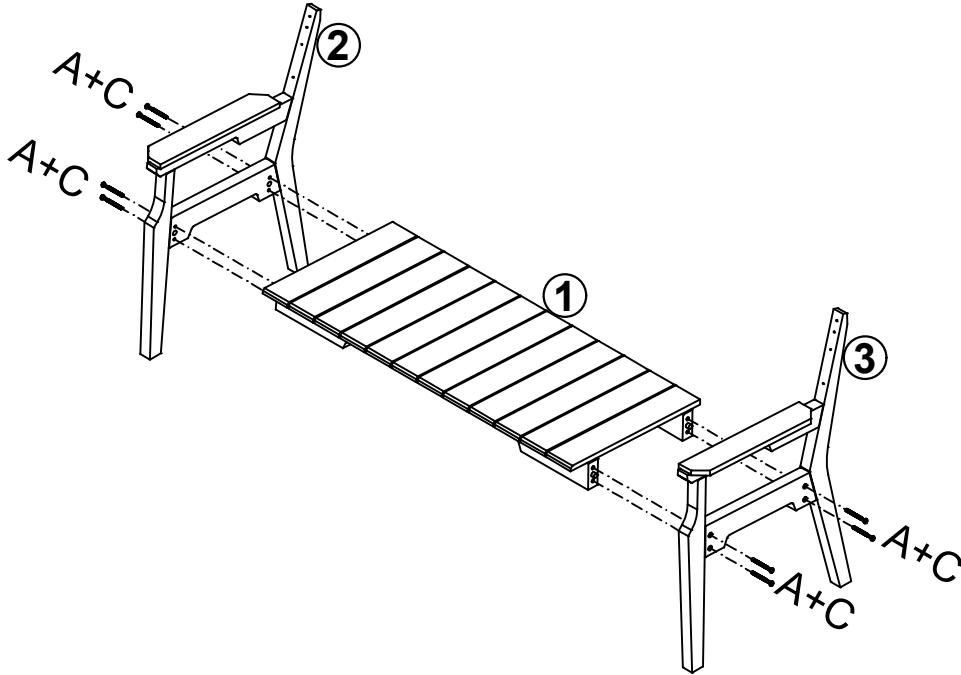
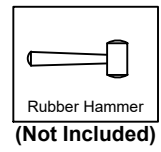
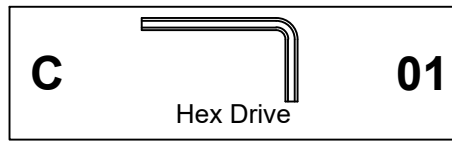
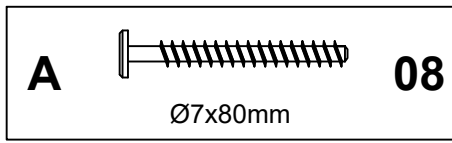

02

