

ASSEMBLY INSTRUCTIONS

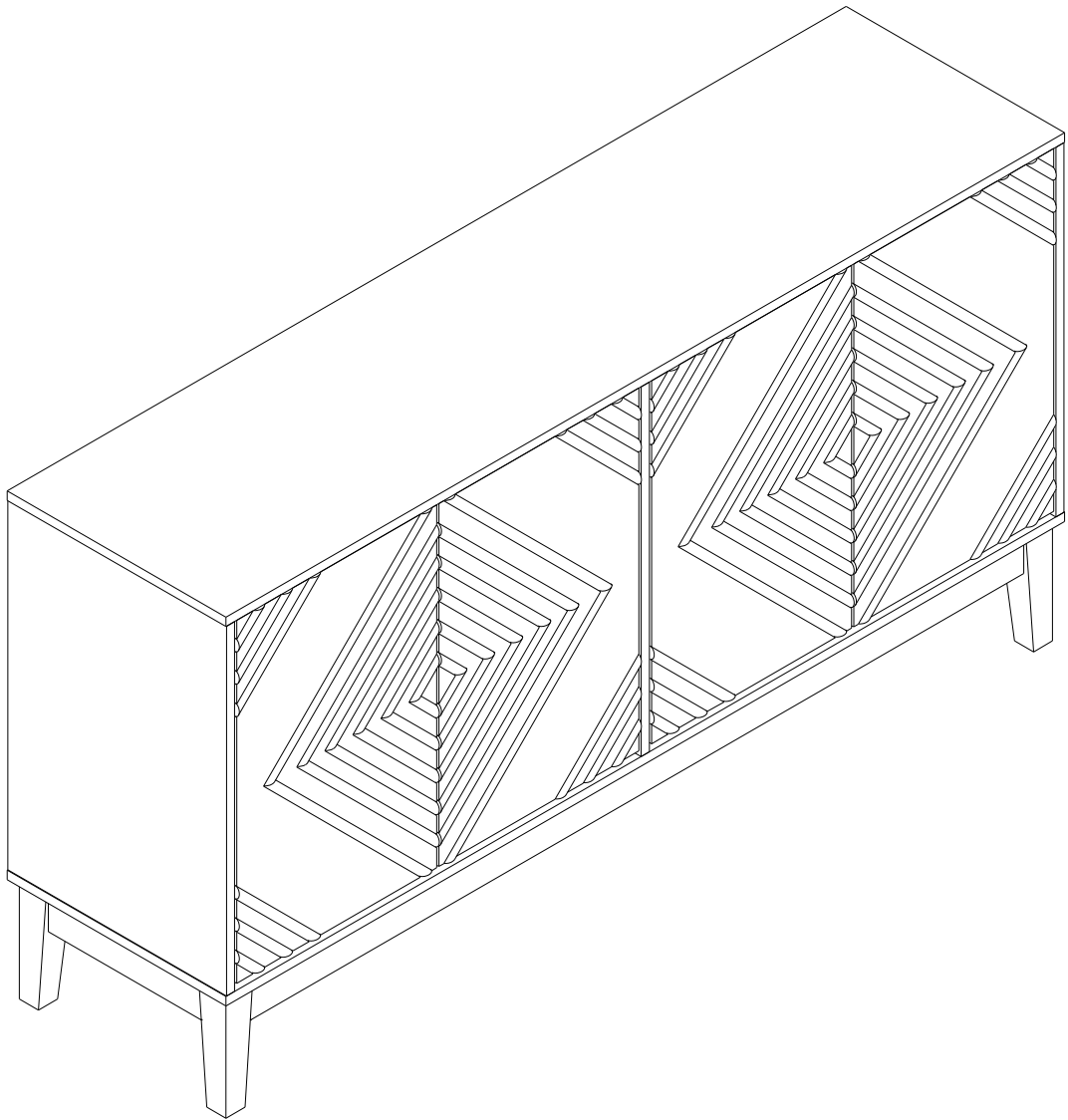

Notice:

1. Follow the installation instructions. Please confirm all accessories are preset before installation.
2. Do not fully tighten the screws during initial assembly. Fully tighten screws only once all pieces which are correctly assembled.
3. If you encounter any problems during installation, please contact our customer service.
4. Please unbox the item from the side with an open-label and put a carpet on the floor to avoid scratching it.

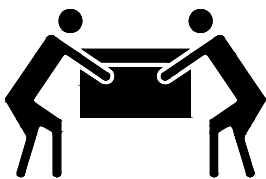

Recommended installers:2

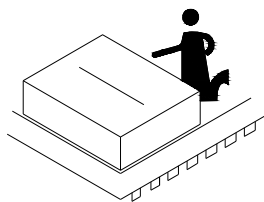

Put a carpet on the floor
before unpacking

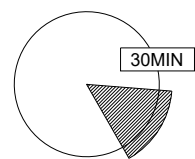

Estimate installation time:
30minutes





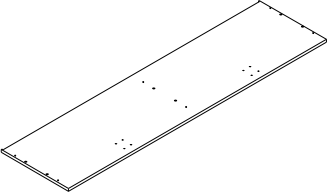
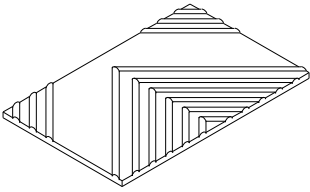
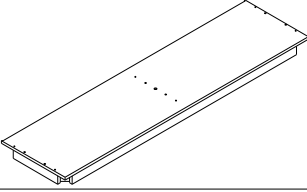
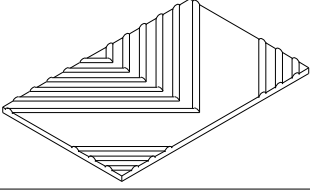
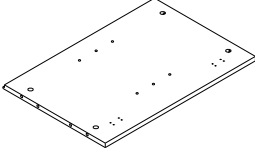
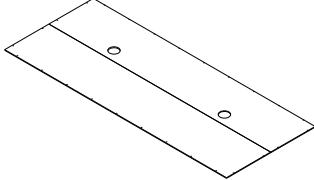
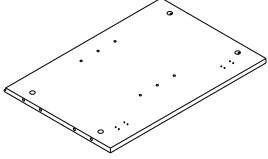
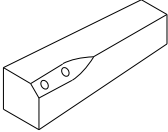
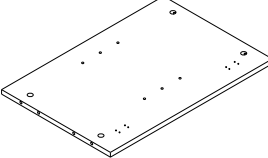
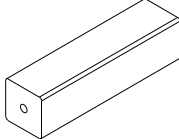
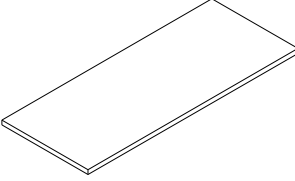





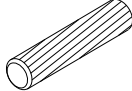
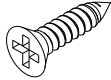

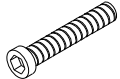
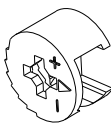
ASSEMBLY INSTRUCTIONS

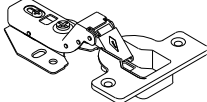
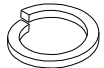
PART LIST

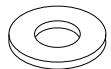
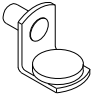
Item no.	Reference Image	Qty	Item no.	Reference Image	Qty
(A)		X1	(G)		X2
(B)		X1	(H)		X2
(C)		X1	(I)		X1
(D)		X1	(J)		X4
(E)		X1	(K)		X1
(F)		X2			

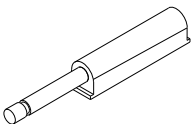
ASSEMBLY INSTRUCTIONS

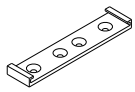
HARDWARE LIST

Item no.	Reference Image	Qty	Item no.	Reference Image	Qty
1	 Ø8*30mm	X12+1	9	 Ø3*15mm	X8
2		X12+1	10	 Ø1/4"*2"	X8
3		X12+1	11	 Ø1/4"*1"	X1
4		X8	12		X9
5	 Ø3*14mm	X48+4	13		X9
6		X8	14	 Ø3*15mm	X24+2
7		X4	15		X1
8		X4	16		X2

ASSEMBLY INSTRUCTIONS

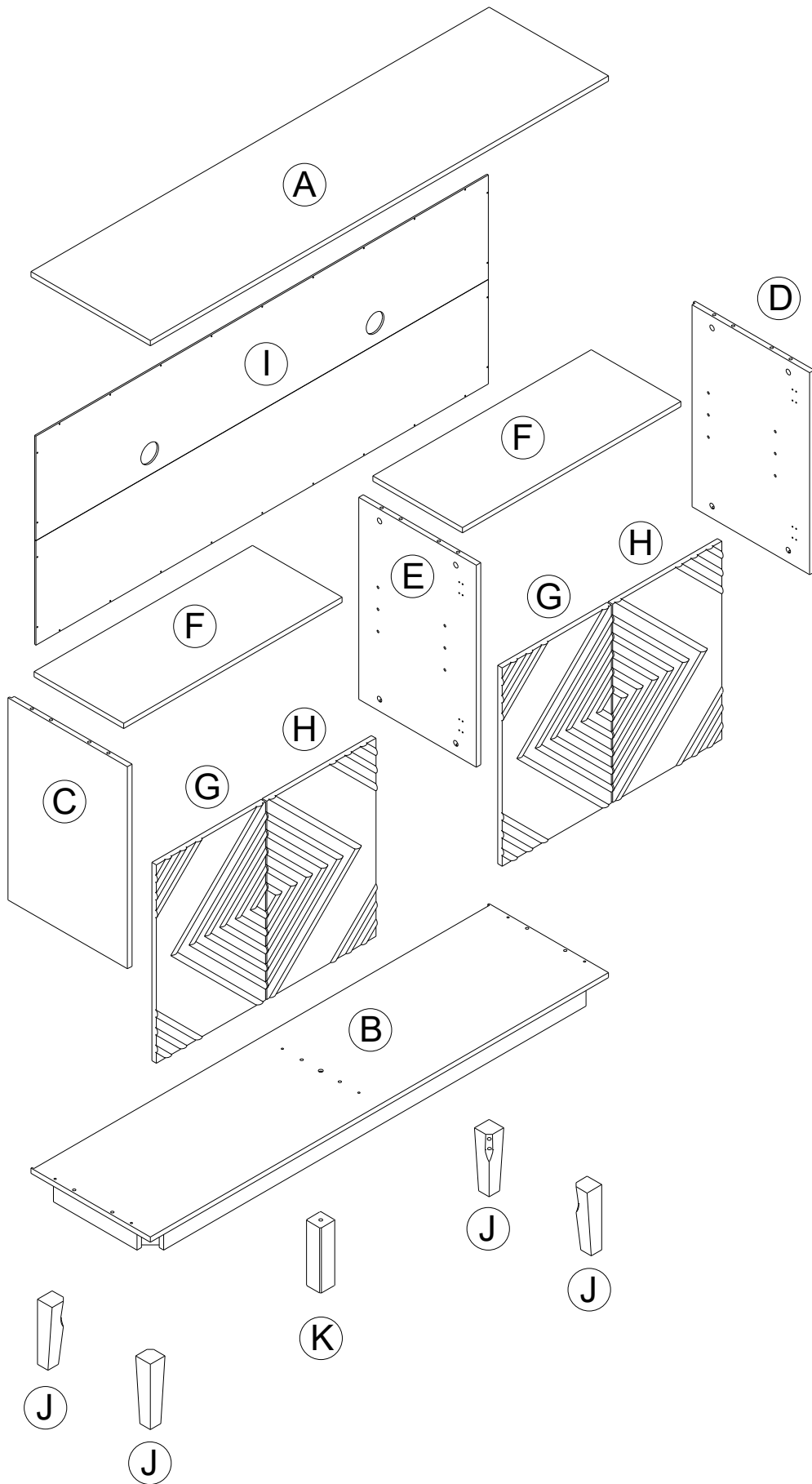

ASSEMBLY INSTRUCTIONS

1

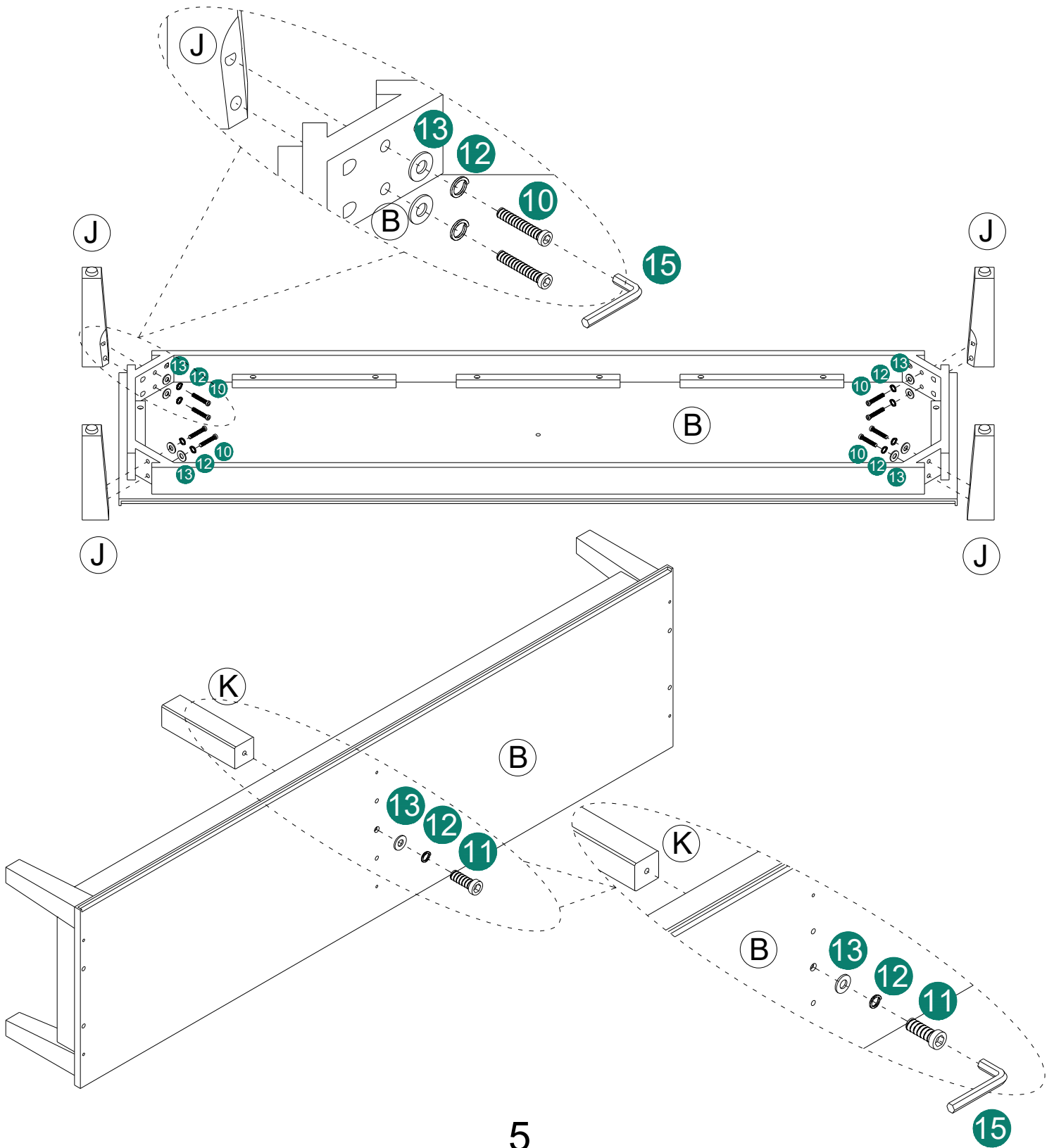
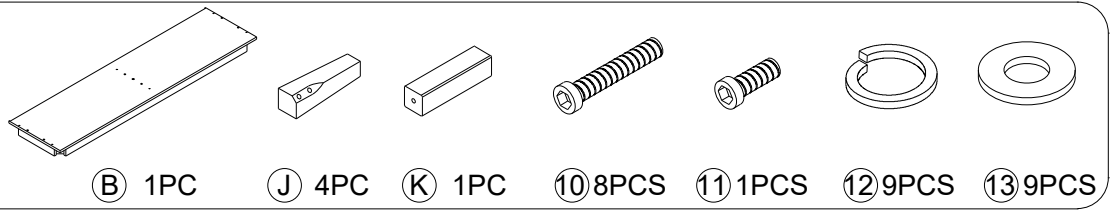

ASSEMBLY INSTRUCTIONS

2

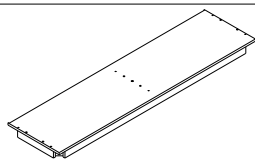

(B) 1PC



(2) 6PCS

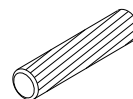

(1) 6PCS

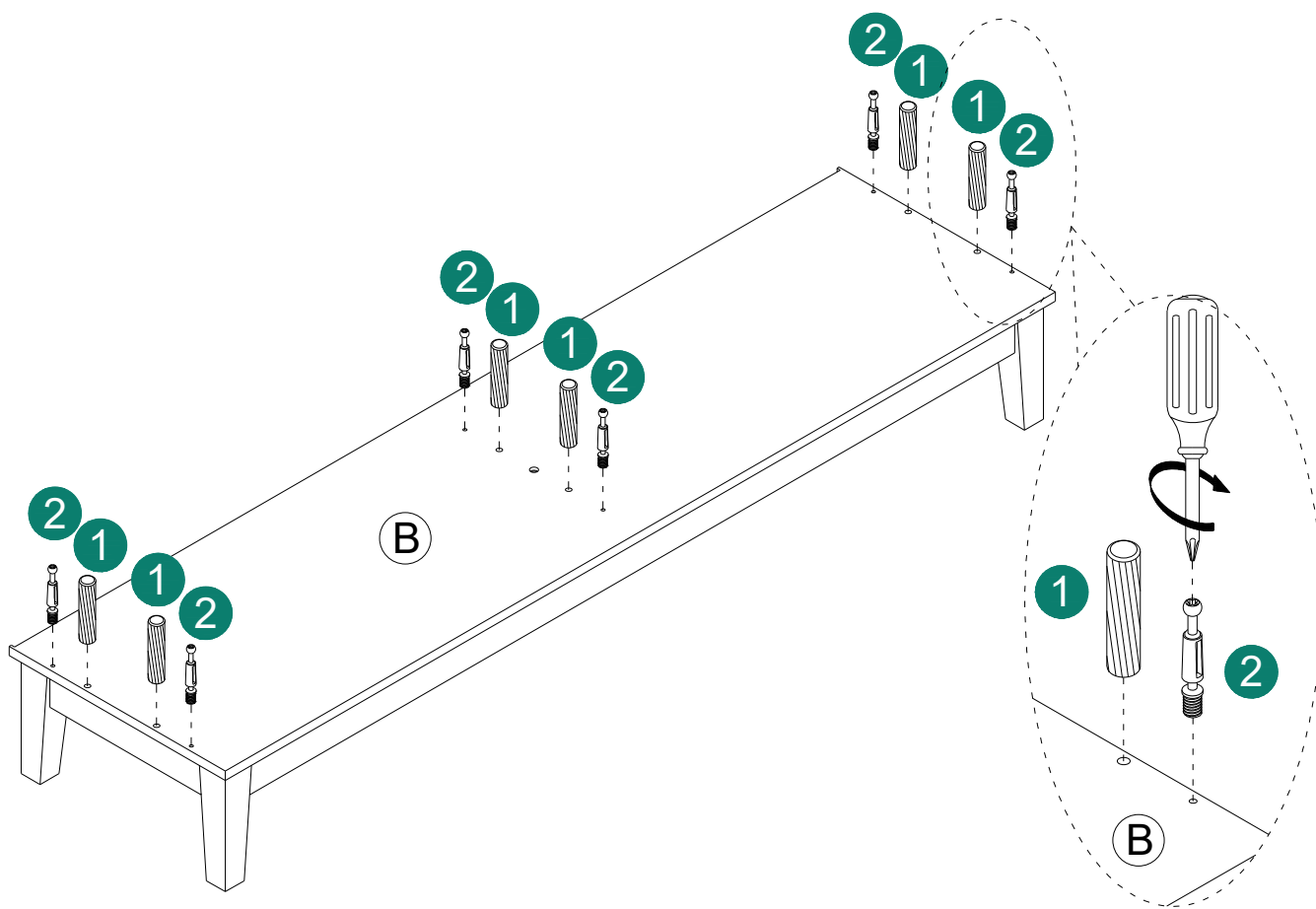

ASSEMBLY INSTRUCTIONS

3

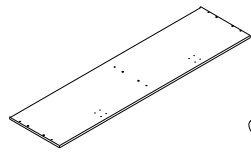

(A) 1PC

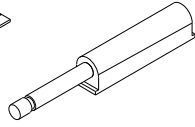

(7) 4PCS

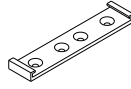

(8) 4PCS

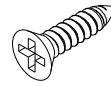

(9) 8PCS



(2) 6PCS

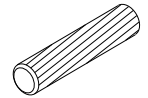

(1) 6PCS

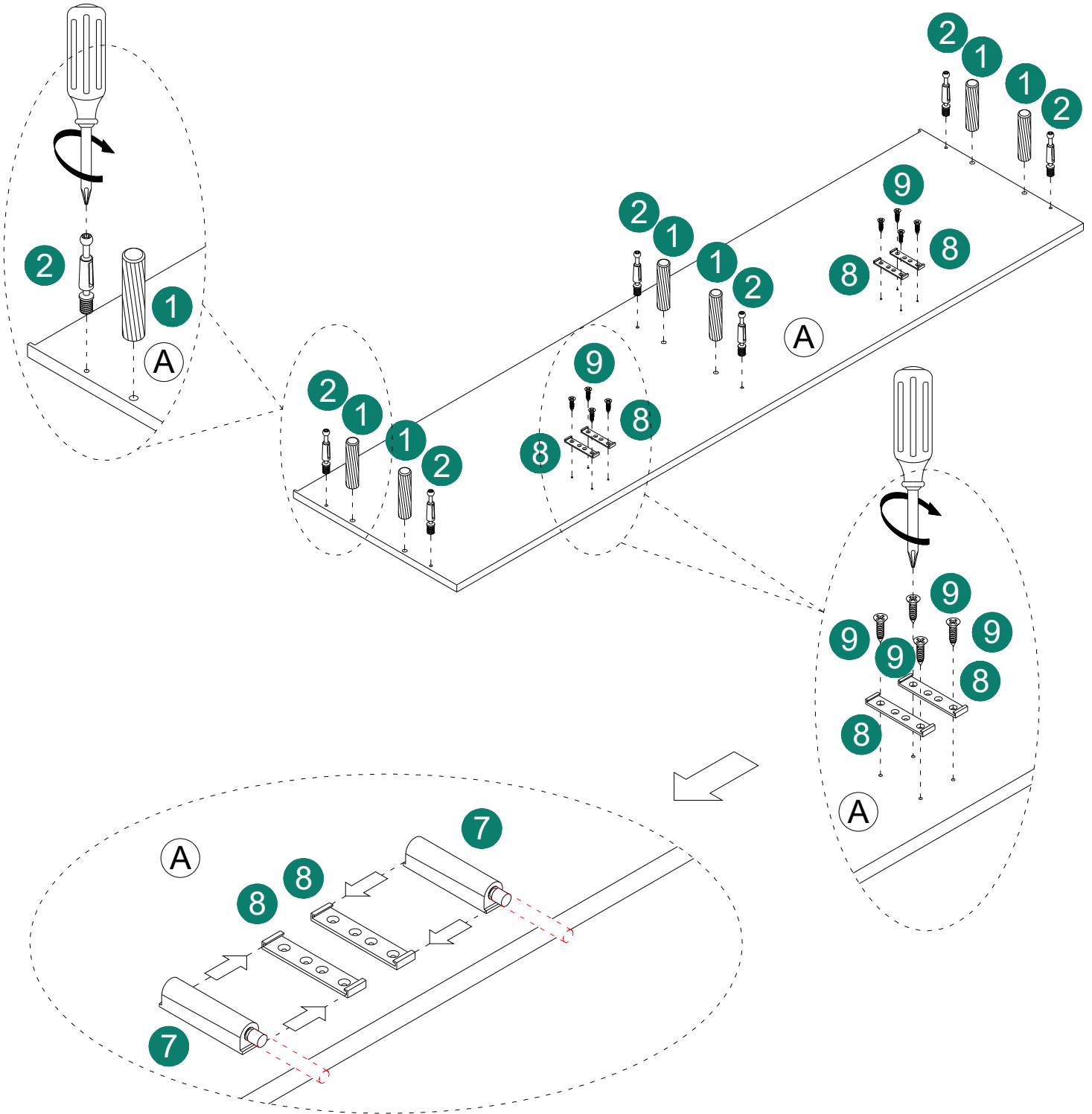

ASSEMBLY INSTRUCTIONS

4

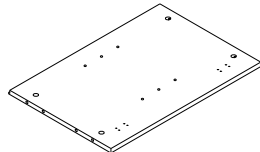

C 1PC

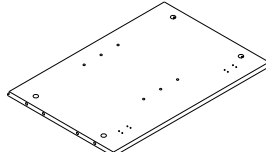

D 1PC

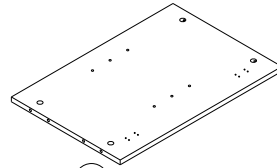

E 1PC

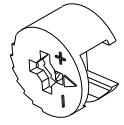

3 6PCS

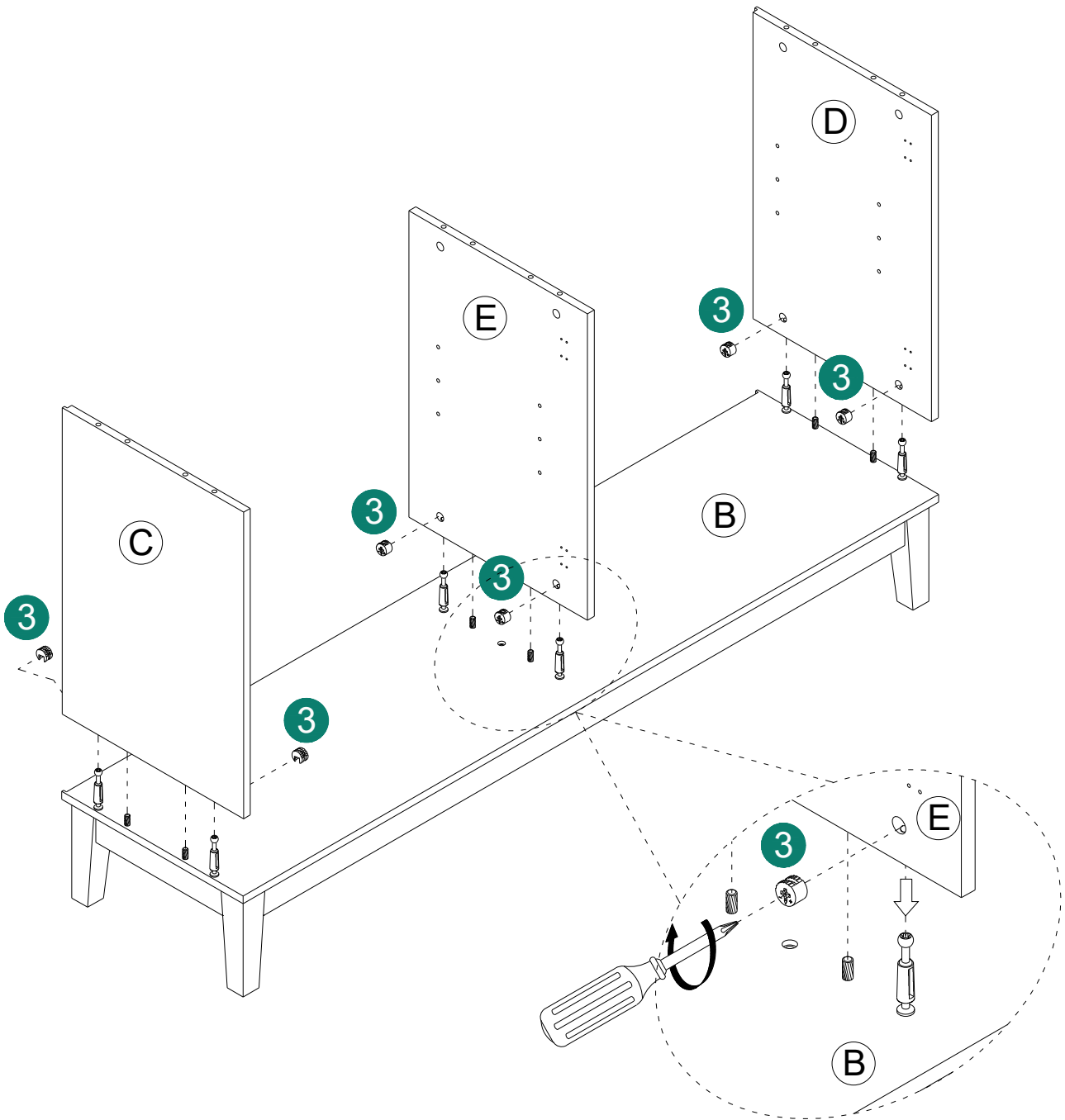

ASSEMBLY INSTRUCTIONS

5

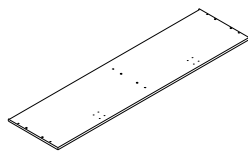

(A) 1PC

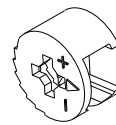

(3) 6PCS

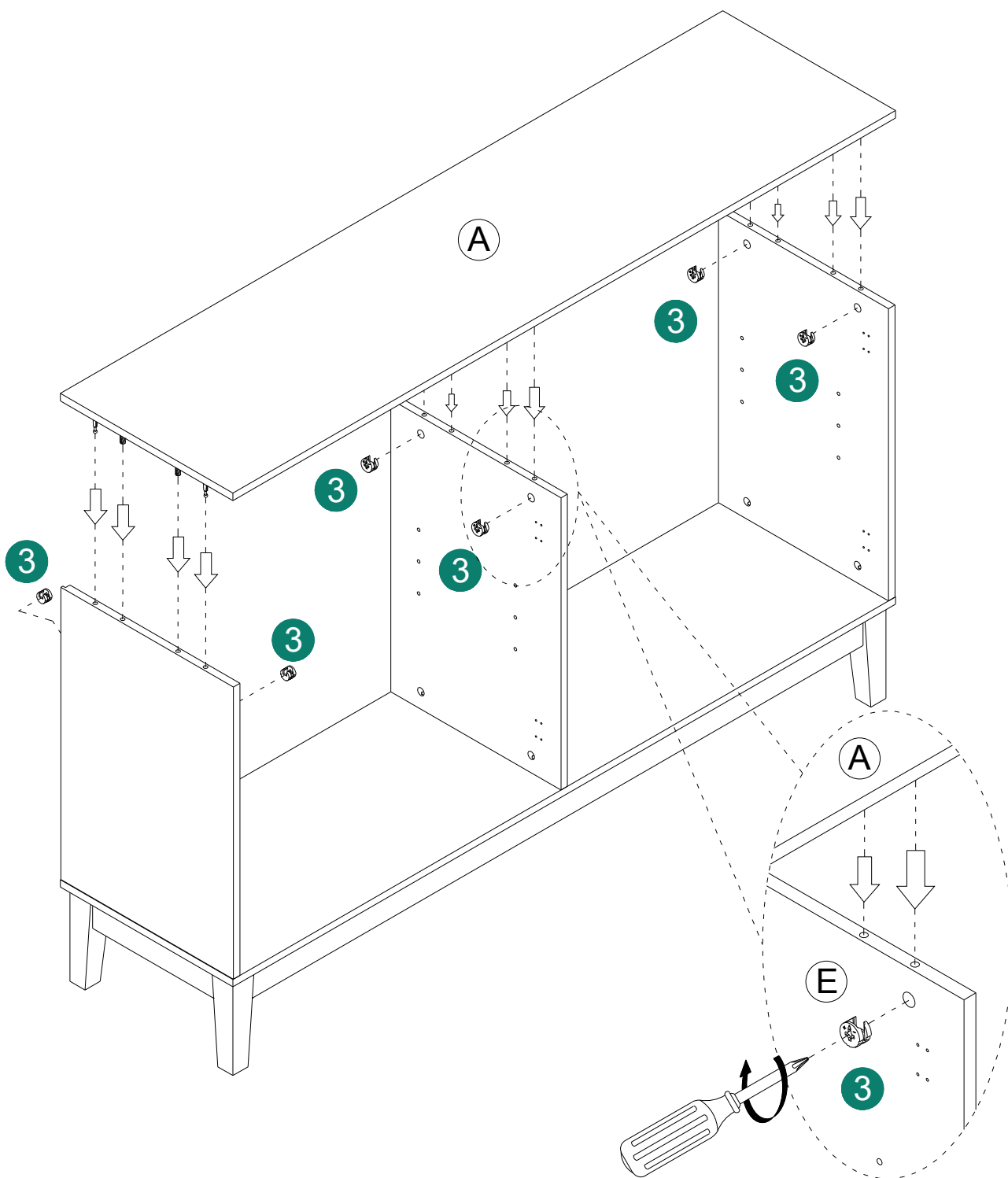

ASSEMBLY INSTRUCTIONS

6

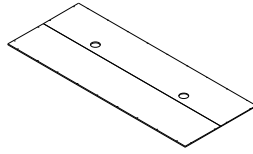

① 1PC



⑭ 24PCS

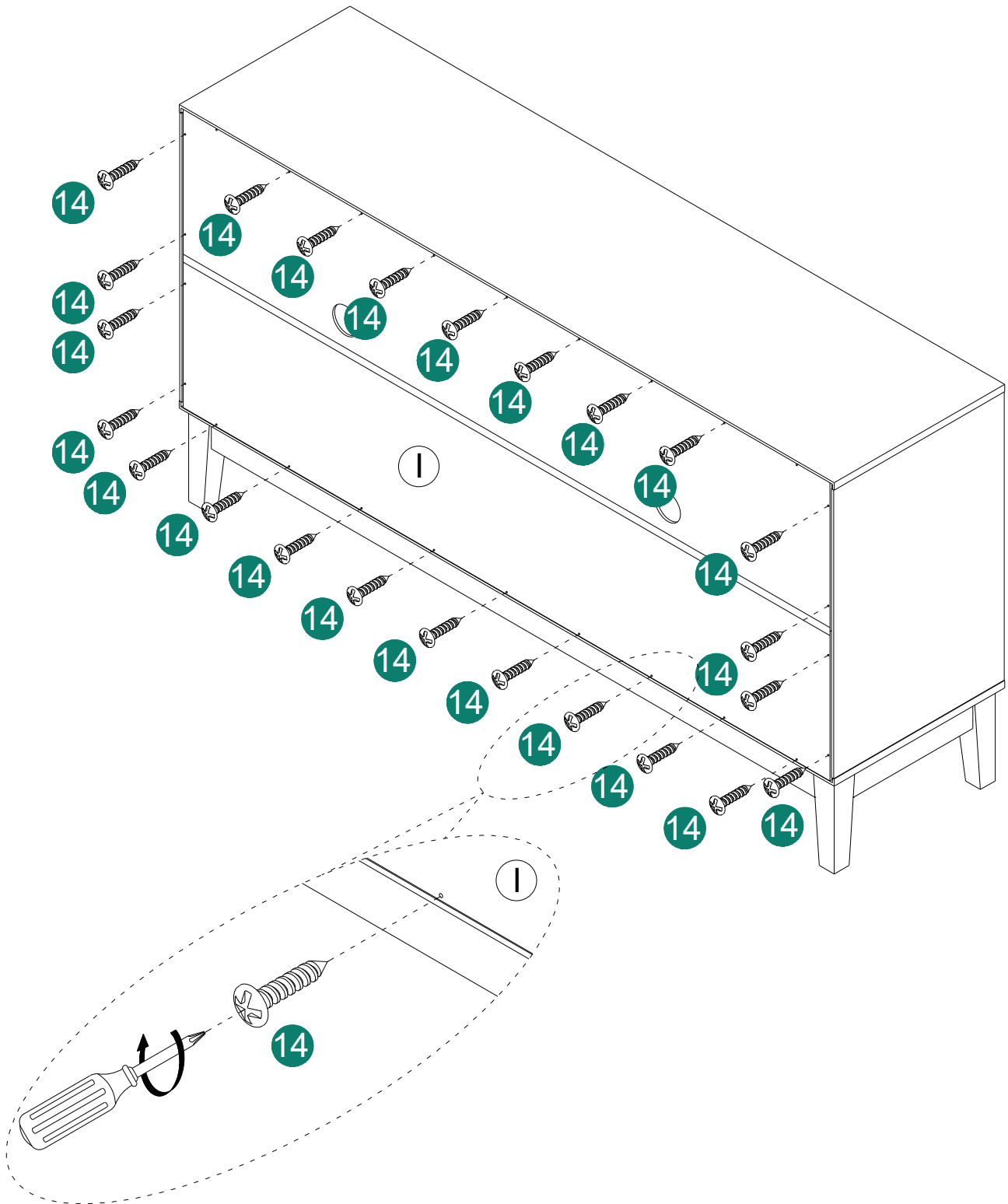

ASSEMBLY INSTRUCTIONS

7

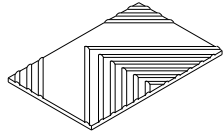

Ⓒ 2PC

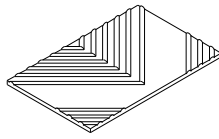

Ⓗ 2PC

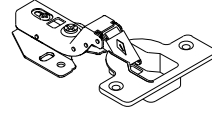

④ 8PCS

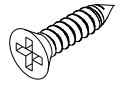

⑤ 16PCS

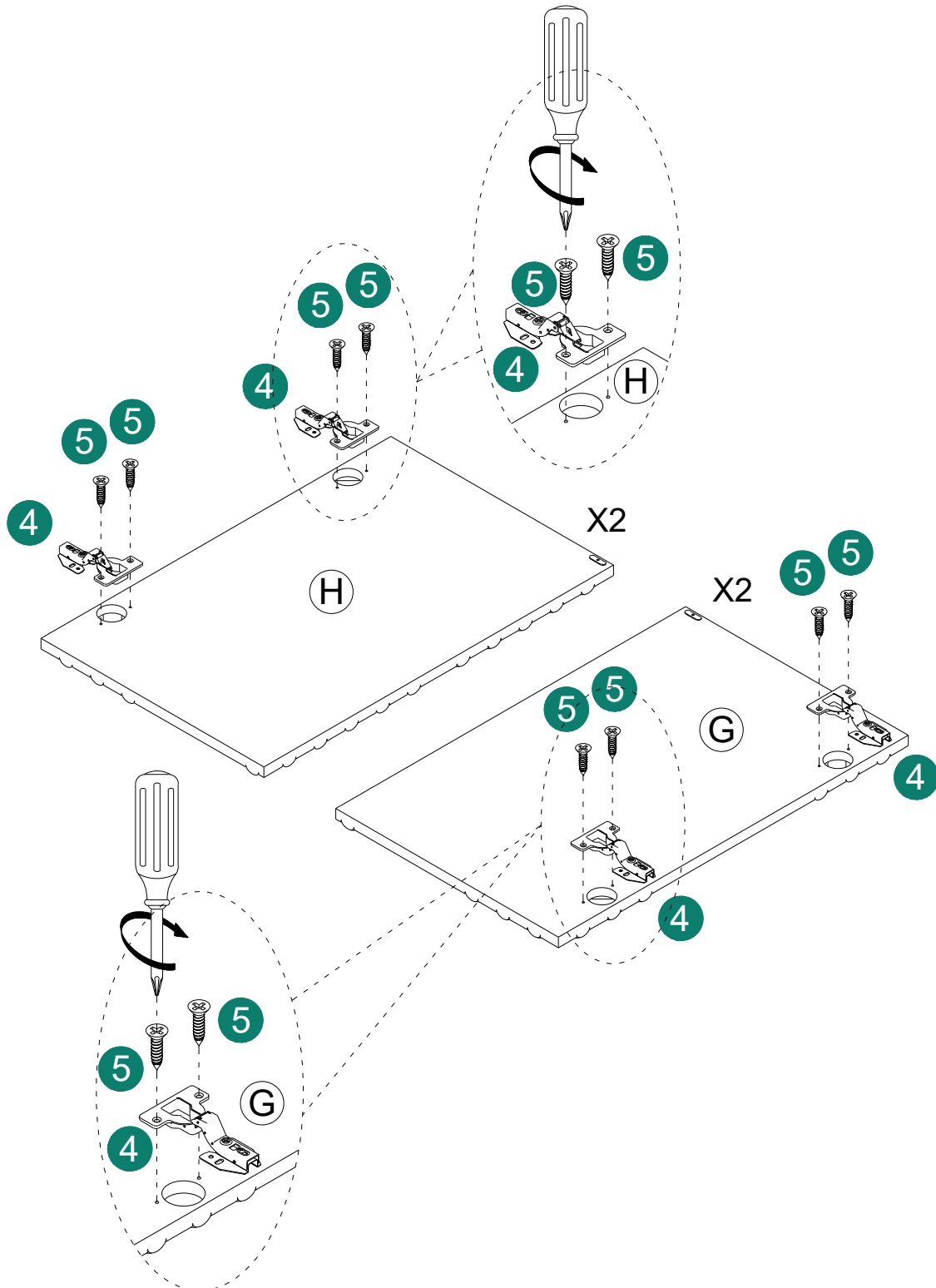

ASSEMBLY INSTRUCTIONS

8

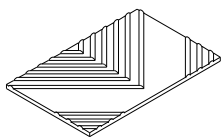

(H) 2PC

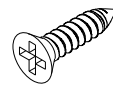

(5) 16PCS

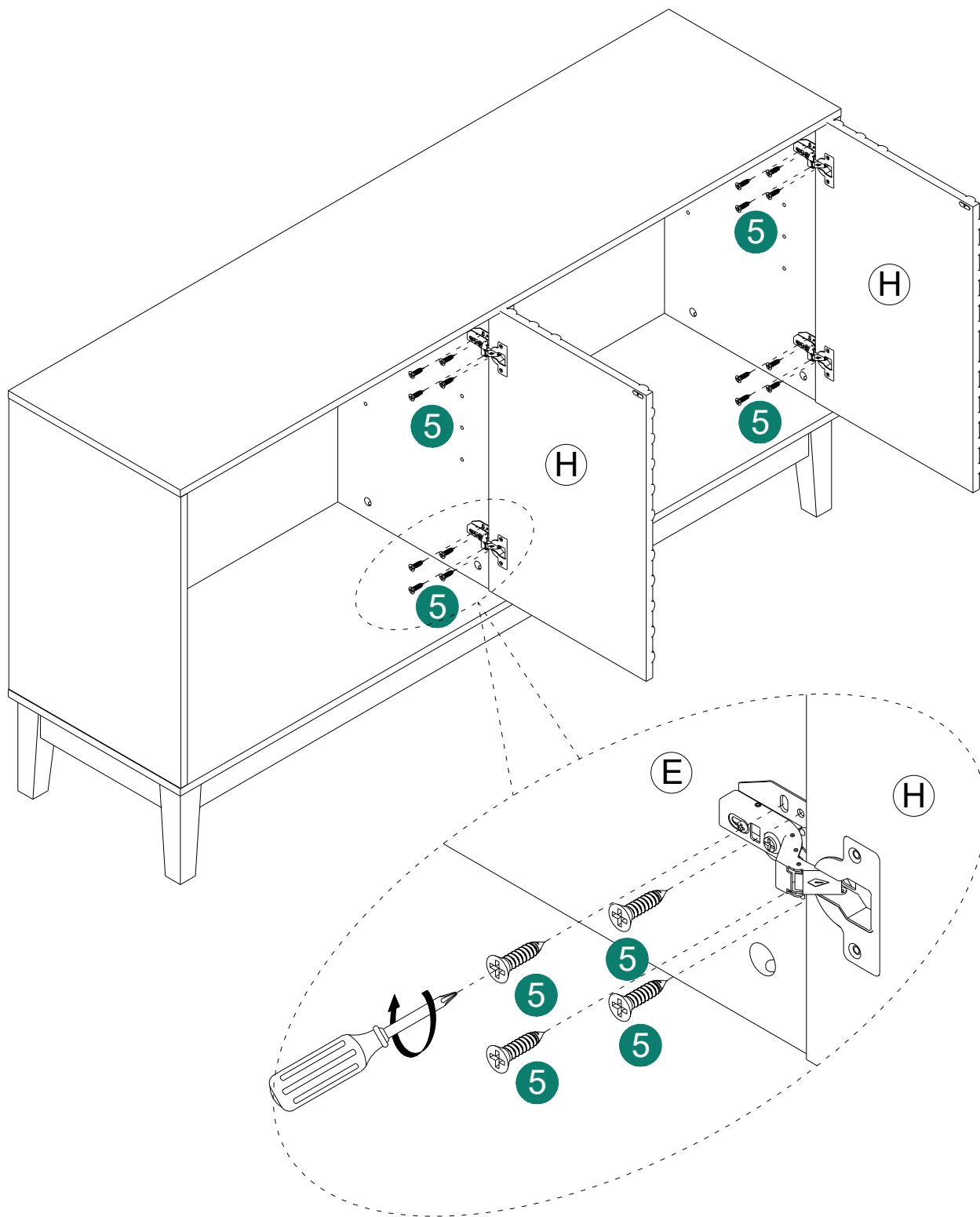

ASSEMBLY INSTRUCTIONS

9

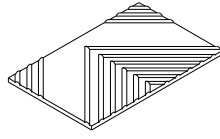

G 2PC

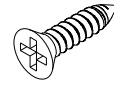

5 16PCS

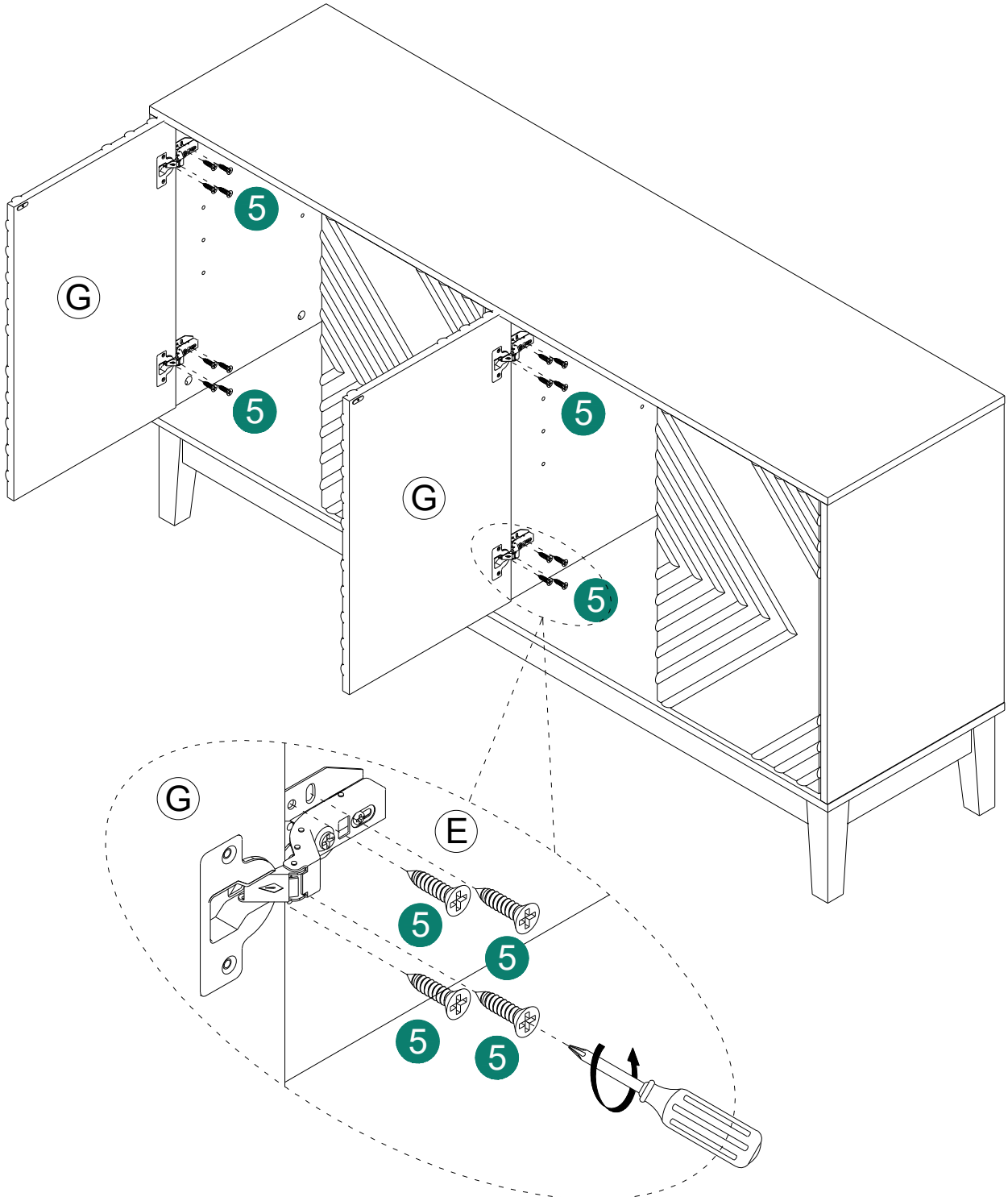

ASSEMBLY INSTRUCTIONS

10

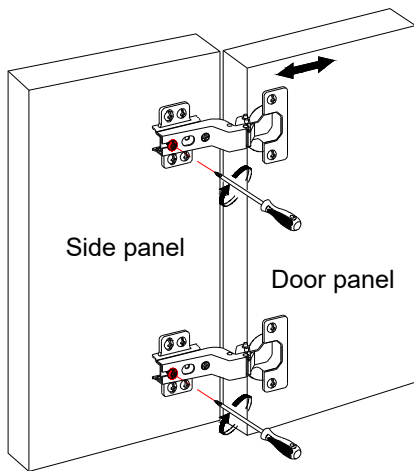

1

Front-to-Back Direction Adjustment:

Rotate the screws on the door hinges shown in the image. The door panel can be moved front-back.

Adjustment range: 4mm

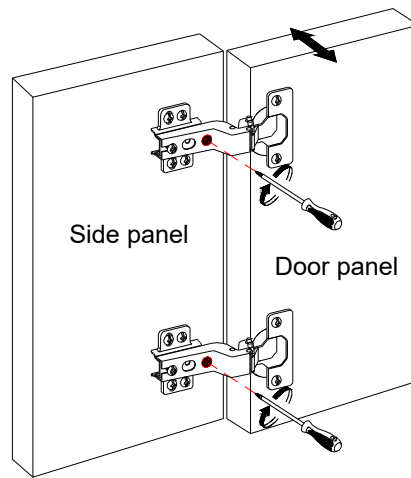

2

Left-Right Direction Adjustment:

Rotate the screws on the door hinges shown in the image. The door panel can be moved left-right.

Adjustment range: 3mm

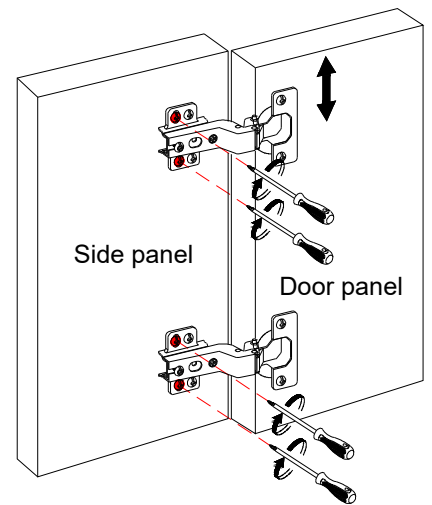

3

Up-Down Direction Adjustment:

Rotate the screws on the door hinges shown in the image. The door panel can be moved up-down.

Adjustment range: 4mm

ASSEMBLY INSTRUCTIONS

11



Common Door Panel Issues:

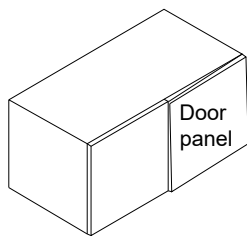

Door panel is not straight

Adjust the door hinges

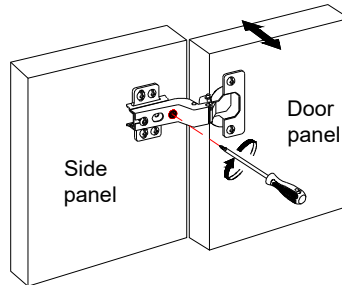

Finished

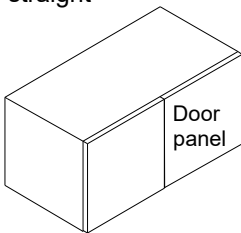
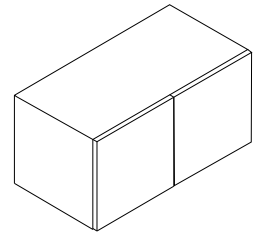

The gap between door panels is too large

Adjust the door hinges

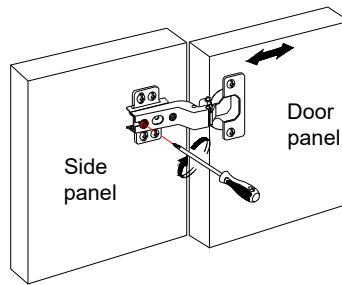

Finished

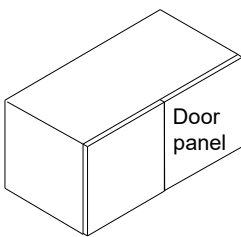
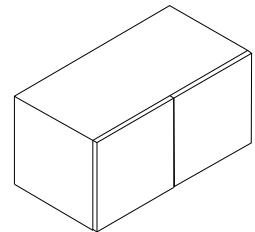

The door panels are not coplanar

Adjust the door hinges

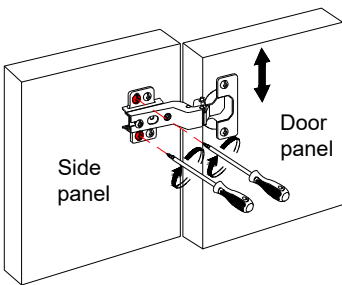

Finished

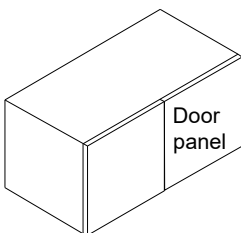
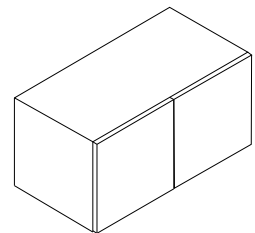

The two door panels are not at the same height

Adjust the door hinges

ASSEMBLY INSTRUCTIONS

12



⑥ 8PCS

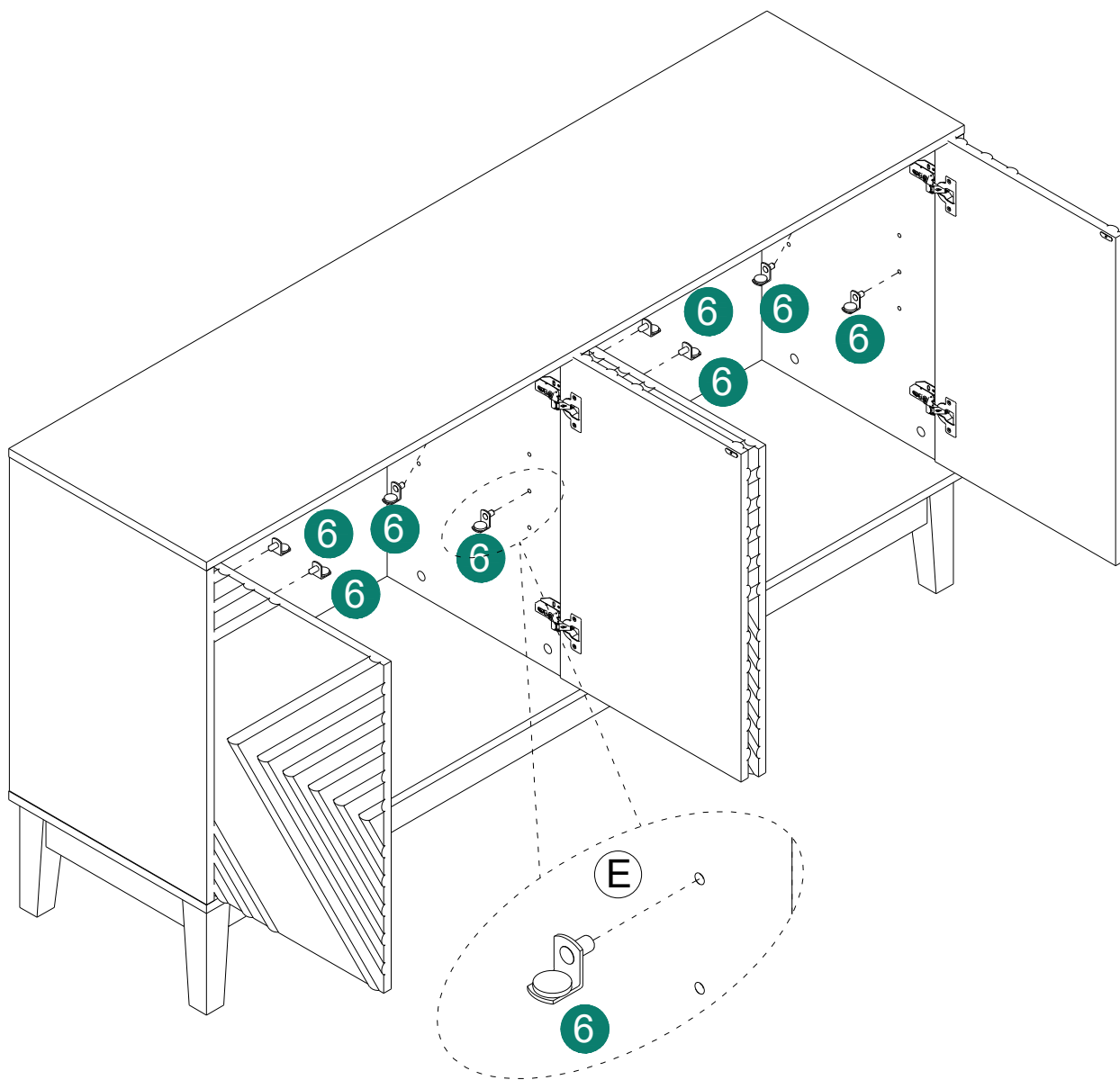

ASSEMBLY INSTRUCTIONS

13

