

# INSTALLATION INSTRUCTION

Please watch the installation video on the details page

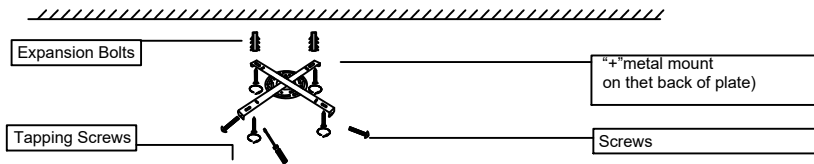

(Figure1)

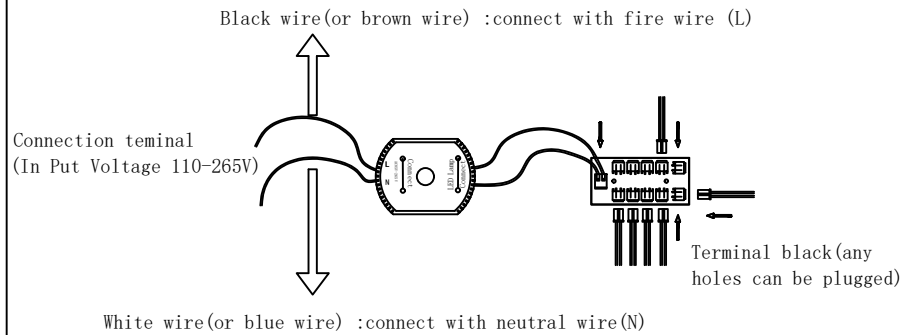

## Installation Steps:

1. Install the "+" metal mount.
2. Remove the protective film wrapped on the lamp body, do not use knives or sharp instrument, so as not to scratch the light body or wire insulation layer.
3. Install five stars lamp head to the light fixture plate
4. Test circuit: Connect the power wires with a temporary wire for testing if the light is working properly before install it to the ceiling.
5. Installation: Fix the lamp body to the cross hardware hanger, connect the power wires with the connecting terminals.
6. Turn on the power and double check again, the installation is complete.



## Warning!

- 1) Please install by professional.
- 2) The voltage available for 110-260V only.
- 3) Don't install the lighting fixture under moist condition.
- 4) Please switch off the power when you cleaning the lighting fixture.
- 5) Keep away from acidic & corrosive material.

# Installation instructions for Metal mount

This job will go easier with two people, because the light needs support during assembly, and it helps having somebody to read the directions. I am referring to the acrylic pieces "the stars" and the round metal thing as "the light fixture metal plate."

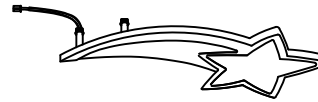

1: Threading the wire through to the double ended metal tube and Install two tubes to the the petal.

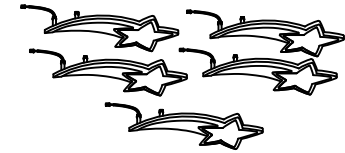

2: Install ten double ended metal tubes to the the petals.



lock washers x10



nuts x10

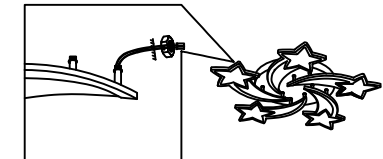

Threading the wire through to the inside of the round light fixture metal plate and place the tubes of petal into corresponding holes on the edge of the round metal fixture one by one (You can see the install video on the product page) :



double ended metal tube x10

Fasten each tube to the light fixture metal plate with a lock washer and a nut. It will look very flat, not 3D.

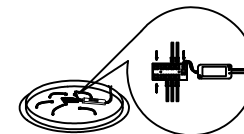

5: First: Very carefully plug the 5 tiny little plugs to the control block, any hole can be plugged. Second: After finishing install the light fixture, you can install it to your ceiling.

### Notice:

The black wire (or brown wire) is connect to fire wire (L);  
The white wire (or blue wire) is connect to neutral wire (N);

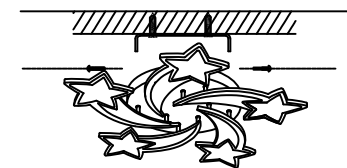

6: Fix the lamp to the metal mount with screw on the ceiling.