

# ASSEMBLY GUIDE

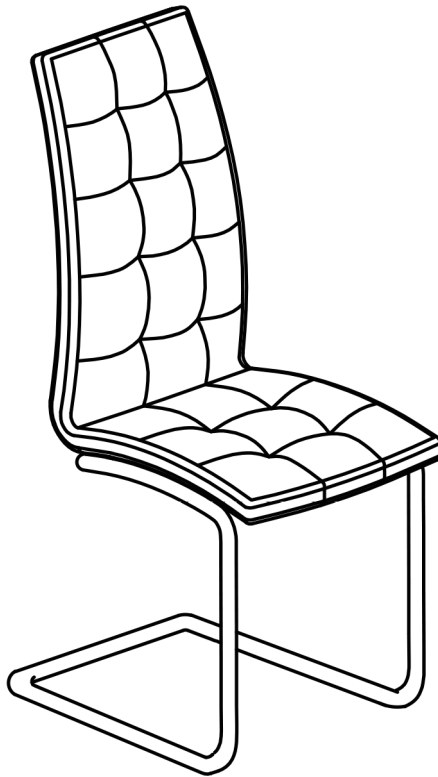

**Important - Please read these instructions fully before starting assembly**



### **SAFETY AND CARE ADVICE**



### **NO POWER TOOLS**

#### **SAFETY AND CARE ADVICE**

- Check you have all the components and tools listed.
- Remove all fittings from the plastic bags and separate them into their groups.
- We do not recommend the use of power drills/drivers for inserting screws, as this could damage the unit. Only use hand screwdrivers and Allen keys.
- Keep children and animals away from the work area, small parts could cause choking if swallowed.
- Make sure you have enough space to layout the parts before starting.
- Assemble the item as close to its final position (in the same room) as possible.
- Do not overtighten the nuts to avoid causing damage to the threads.
- Only clean using a damp cloth and mild detergent, do not use bleach or abrasive cleaners.
- From time to time check that there are no loose screws on this unit
- This product should not be discarded with household waste. Take to your local authority waste disposal centre

## IMPORTANT INFORMATION



ONE  
PERSON



30 MINUTE  
BUILD



MAXIMUM  
CAPACITY  
150Kg



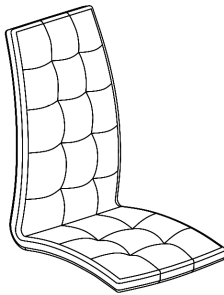

PLEASE CHECK CAREFULLY AND MAKE SURE YOU HAVE ALL FITTINGS AND TOOLS LISTED BELOW BEFORE YOU START.

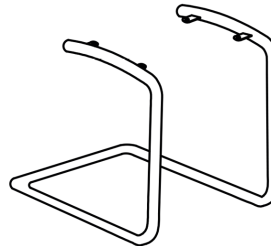

1 Back rest x 1



2 Leg frame x 1

<p>A</p>  <p>M6x16mm Allen Screw X4</p>	<p>B</p>  <p>M6x16mm Metal Washer X4</p>	<p>C</p>  <p>M6x10mm Spring Washer X4</p>	<p>D</p>  <p>M4 mm Allen Key X1</p>
--	---	--	---

**NOTE:** The quantities above are the correct amount to complete the assembly. In some cases more fittings may be supplied than are required.

## STEP 1

Place the seat [2] on a flat surface (ie. table top) with the back overhanging.

Line the legs [1] up with the seat holes.

Using allen key (D) tighten the chair legs onto the seat using fixings (A), (B) & (C)

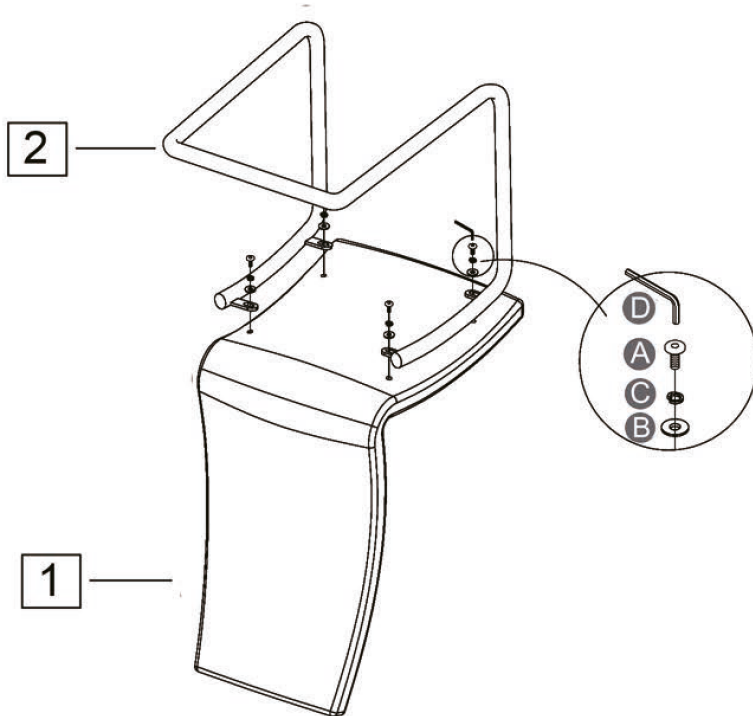

## STEP 2

Sit on the chair and fully tighten all bolts.

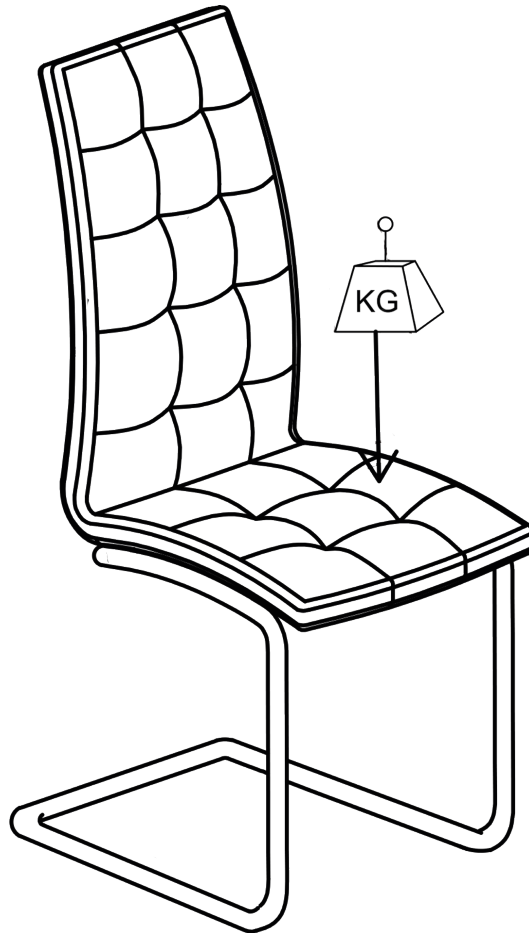

## WHAT THE GUARANTEE COVERS



**PRE-INSERTED FIXINGS**  
e.g. lose metal threads



**FAULTY JOINTS**  
e.g. legs bending



**EXTERNAL FIXING FAULTS**  
e.g. metal discs removing  
from table top



**STRUCTURAL INTEGRITY**  
e.g. the frame of the  
product