

# Storage Cabinet

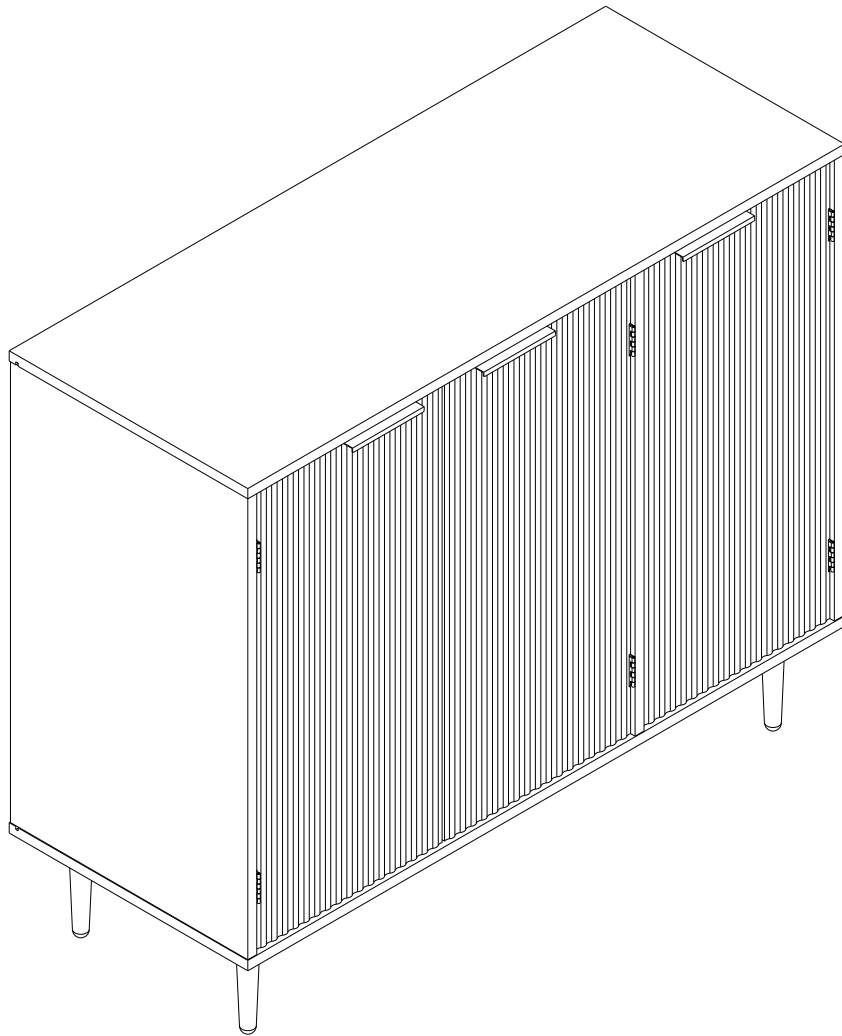

Made in China

# For a Hassle-Free Installation

- 1.Ensure you have received all cartons and familiarize yourself with the workload. Make sure there are enough helping hands to assist you, and that you have allocated the time required to assemble your new product.
  2. Make sure you have cleared enough space in your home for the assembly. We recommend protecting your floor with a mat or cardboard to avoid scratches during the assembly process.
  3. Read instructions carefully and check no parts are missing.
  4. Lay out all hardware on a soft surface so you can easily identify them.
  5. Carefully identify all components according to the labeled alphabet to ensure that the parts are in the correct place.
  6. Install your new product carefully following the instructions. Don't skip ahead!
- \* If any parts are missing or damaged, we will gladly ship you replacement parts free of charge. Please contact us order ID and the Store Name of your purchase, we're always here to help :)

## WARNING

Serious or fatal injury may occur from unexpected assembly or use.

- 1.During the assembly process, keep all parts away from babies or children.
- 2.Always securely fix this product to the wall. Make sure the wall area to be drilled is free from hidden electrical wires, water and gas pipes.
- 3.Use of tip-over restraints may only reduce, but not eliminate the risk of tip-over.
- 4.Unless specially designed to accommodate, do not set heavy objects on top of this product.
- 5.Place the heaviest items on the lowest shelf.
- 6.Never allow children to climb or bang on drawers, doors or shelves.

# Parts List

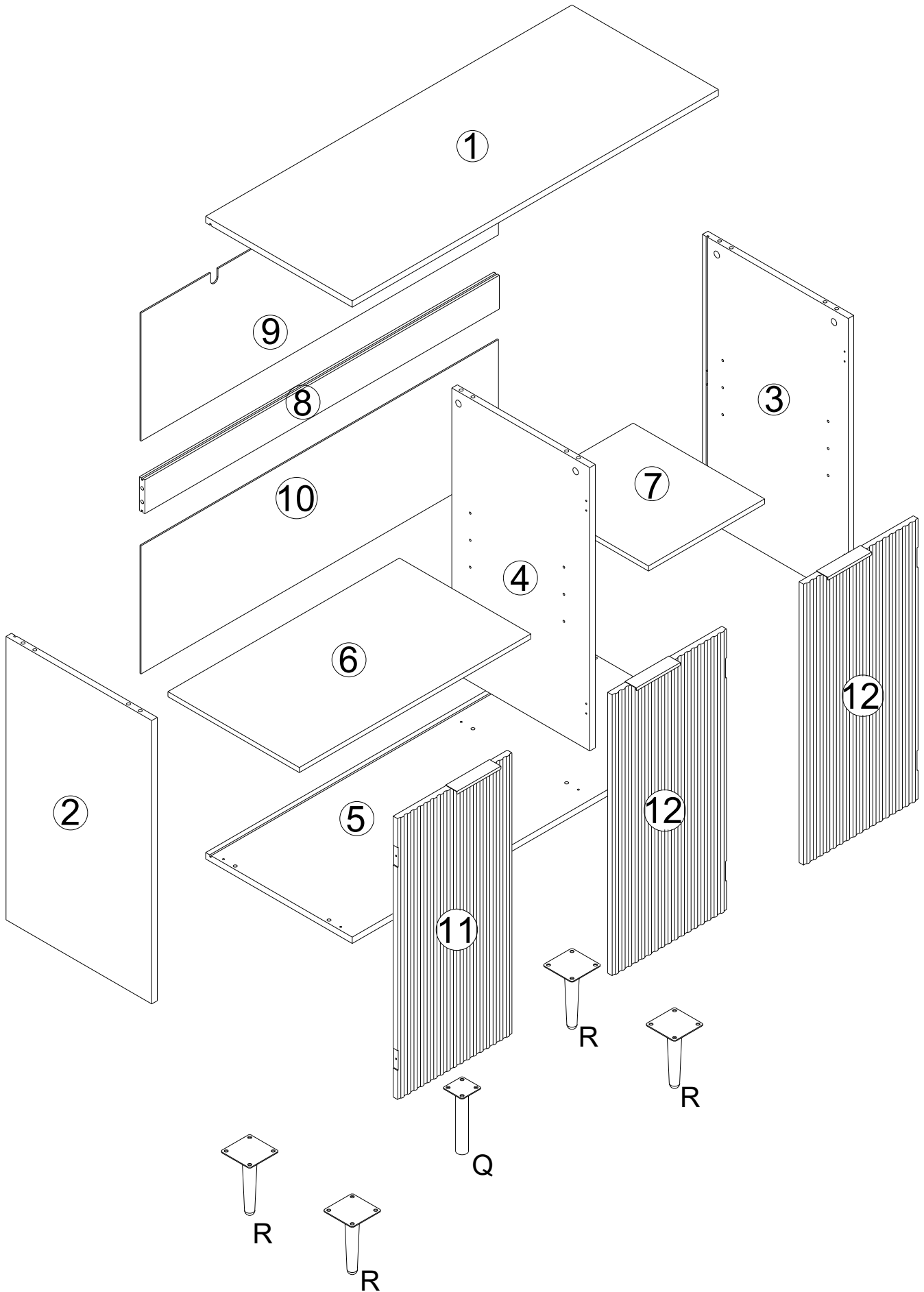

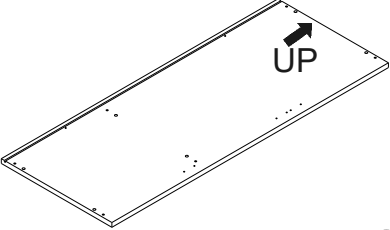
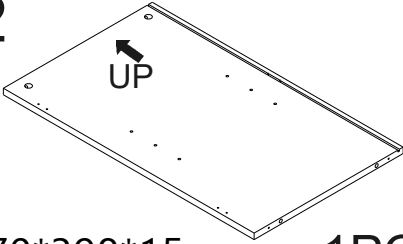
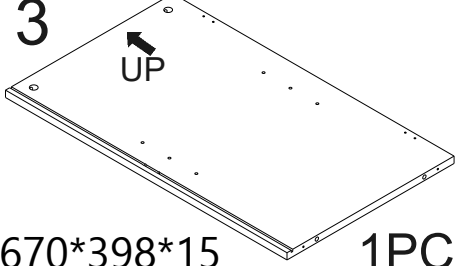
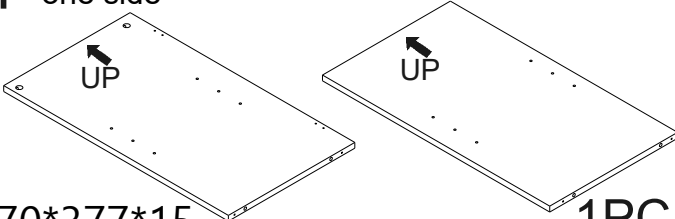
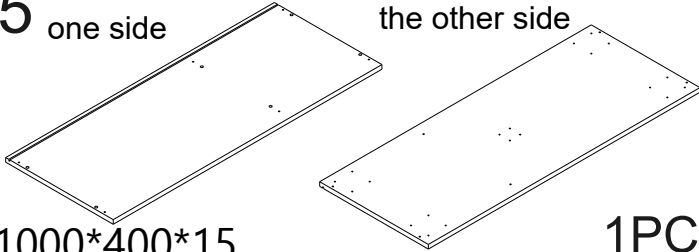
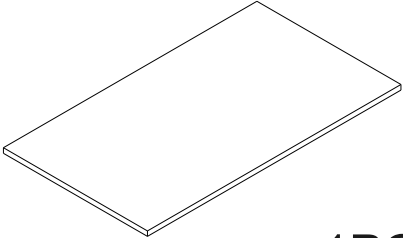
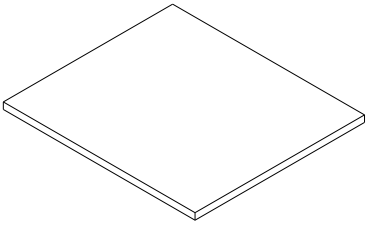
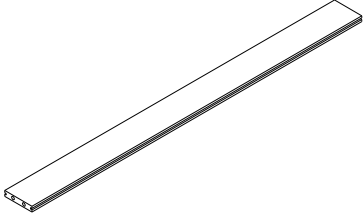
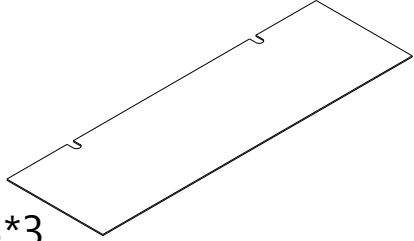
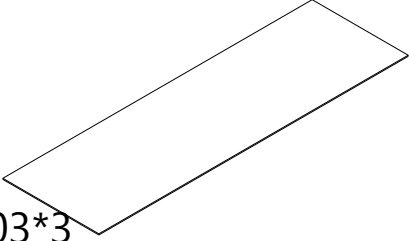
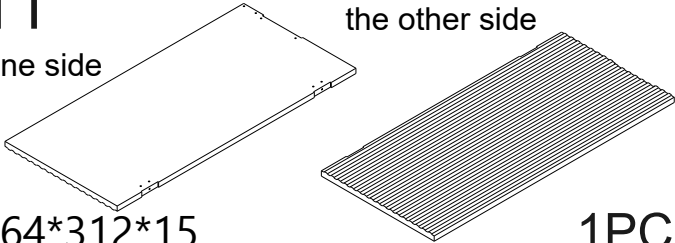
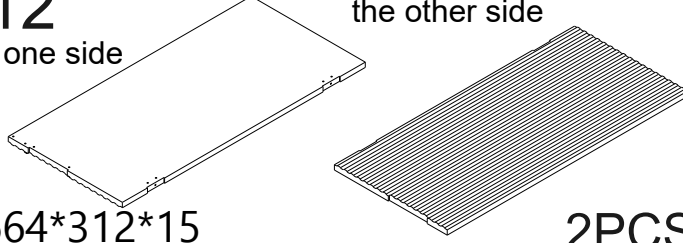

# Parts List

<p><b>1</b></p>  <p>1000*400*15      1PC</p>	<p><b>2</b></p>  <p>670*398*15      1PC</p>	<p><b>3</b></p>  <p>670*398*15      1PC</p>	
<p><b>4</b> one side      the other side</p>  <p>670*377*15      1PC</p>		<p><b>5</b> one side      the other side</p>  <p>1000*400*15      1PC</p>	
<p><b>6</b></p>  <p>632*359*12      1PC</p>	<p><b>7</b></p>  <p>359*317*12      1PC</p>	<p><b>8</b></p>  <p>968*80*15      1PC</p>	
<p><b>9</b></p>  <p>976*303*3      1PC</p>		<p><b>10</b></p>  <p>976*303*3      1PC</p>	
<p><b>11</b> one side      the other side</p>  <p>664*312*15      1PC</p>		<p><b>12</b> one side      the other side</p>  <p>664*312*15      2PCS</p>	

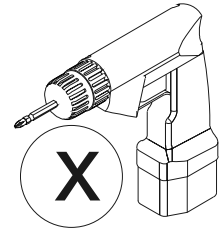
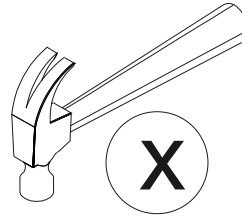
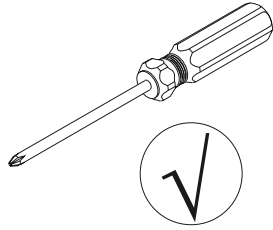
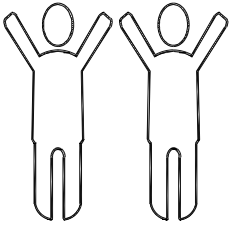
# Hardware List

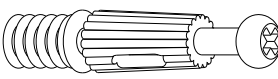
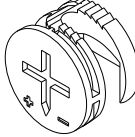
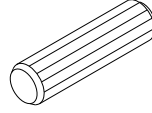

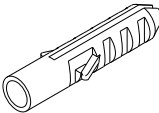
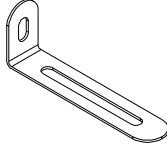
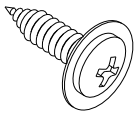
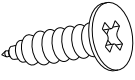
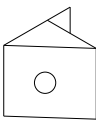
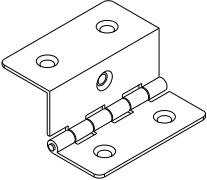
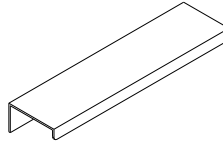
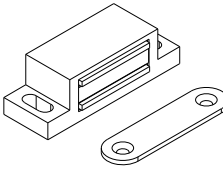
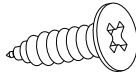
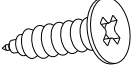
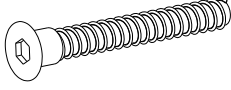
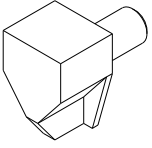
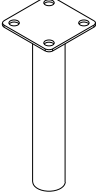
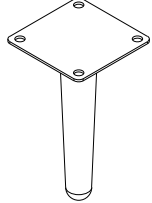
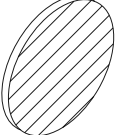
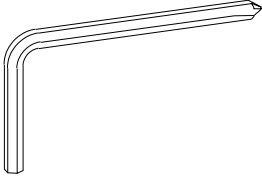
<p><b>A</b></p>  <p>Ø6x36mm      10PCS</p>	<p><b>B</b></p>  <p>Ø15x9.2mm      10PCS</p>	<p><b>C</b></p>  <p>Ø8*30mm      12PCS</p>
<p><b>D</b></p>  <p>M5x38mm      2PCS</p>	<p><b>E</b></p>  <p>Ø8x40mm      2PCS</p>	<p><b>F</b></p>  <p>65x32x15      2 PCS</p>
<p><b>G</b></p>  <p>M3x12mm      2PCS</p>	<p><b>H</b></p>  <p>M3x16mm      18PCS</p>	<p><b>I</b></p>  <p>12.5x14x9.5      12 PSC</p>
<p><b>J</b></p>  <p>42*20*1mm (23)      6PCS</p>	<p><b>K</b></p>  <p>120*31*16mm (96)      3PCS</p>	<p><b>L</b></p>  <p>45*15*14mm      3PCS</p>
<p><b>M</b></p>  <p>M3.5x14mm      42PCS</p>	<p><b>N</b></p>  <p>M4x14mm      20PCS</p>	<p><b>O</b></p>  <p>Ø7*50mm      6PCS</p>
<p><b>P</b></p>  <p>8PCS</p>	<p><b>Q</b></p>  <p>150H      1PC</p>	<p><b>R</b></p>  <p>150H      4PCS</p>
<p><b>S</b></p>  <p>Ø20mm      6PCS</p>	<p><b>T</b></p>  <p>M4      1PC</p>	

# Assembly Steps

## CAM BOLT INSTALLATION AS BELOW:

 Cam bolt

 Connecting piece

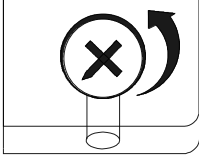

X

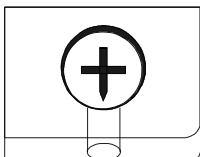

✓

Rotate connecting piece if found in the position illustrated above.

Correct orientation to receive bolts.

**Pin**

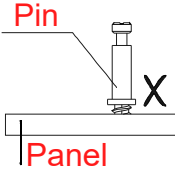

**Panel**

**No gap**

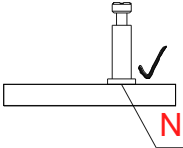

A1.

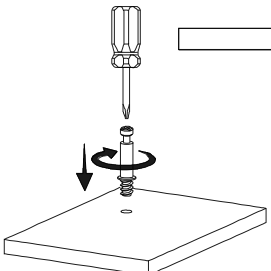

A2.

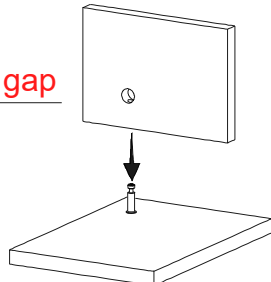

A3.

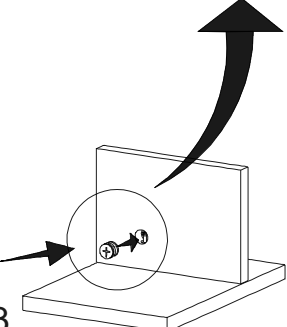

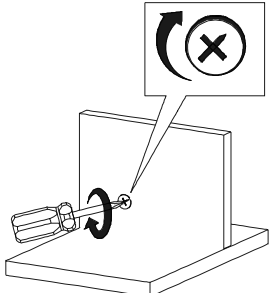

A4.

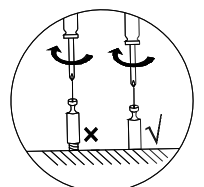
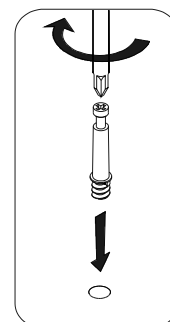
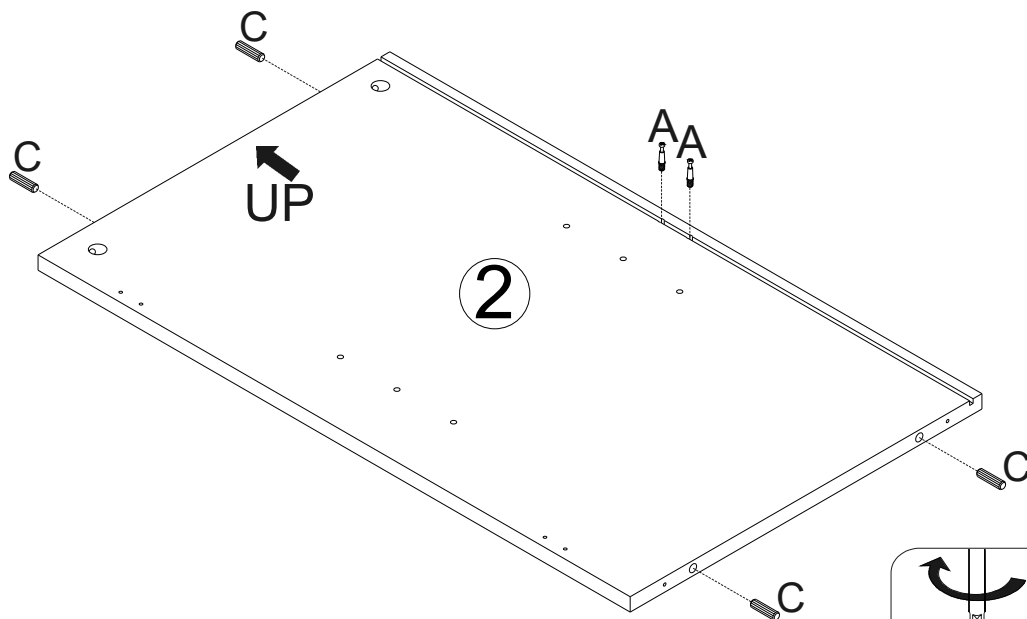

## STEP 1



	A*2PCS
	C*4PCS

# Assembly Steps

## STEP 2

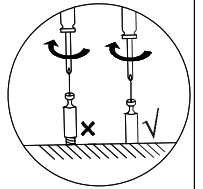
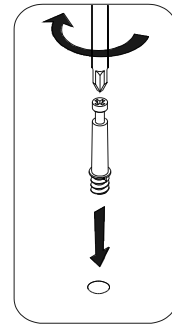
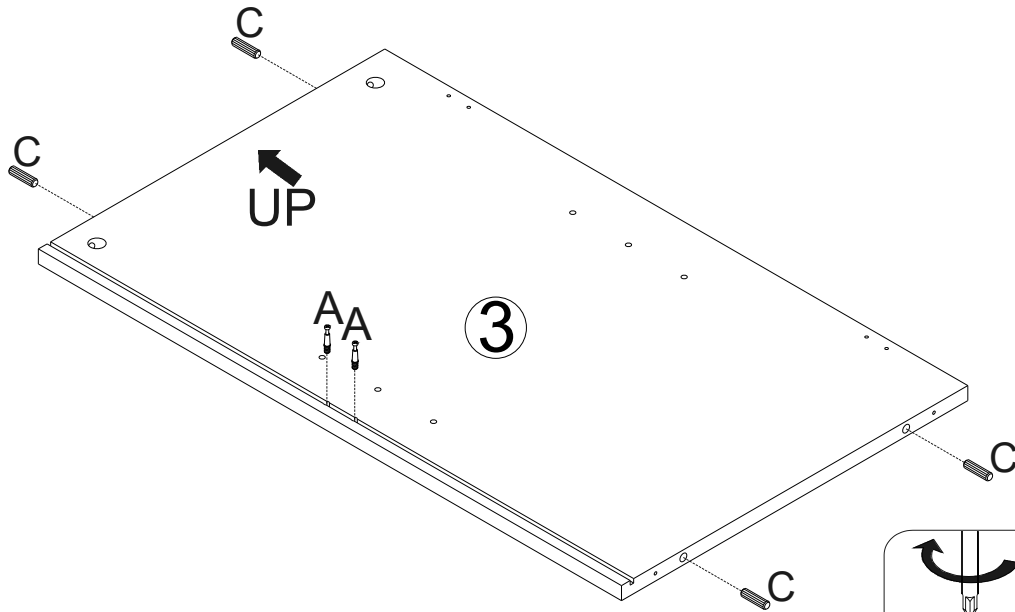

A\*2PCS



C\*4PCS

## STEP 3

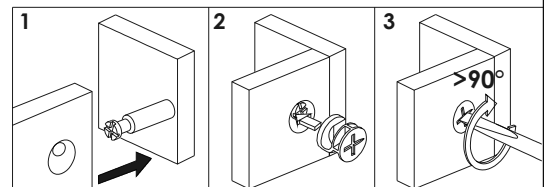
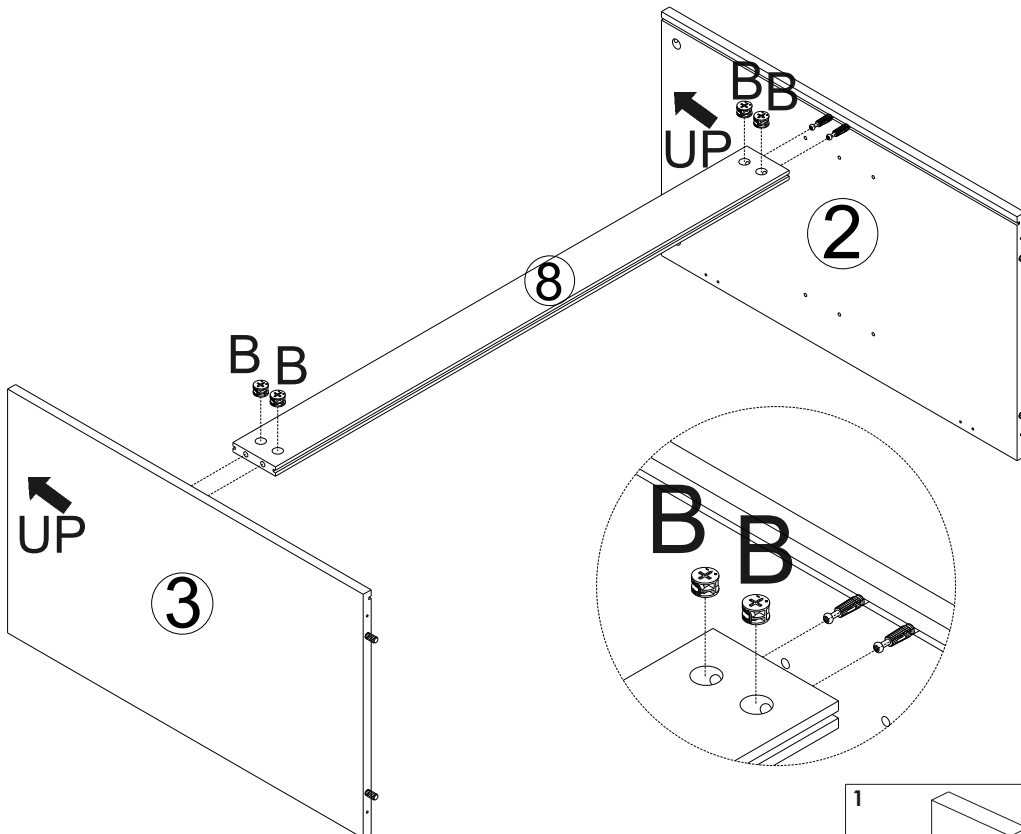

B\*4PCS

# Assembly Steps

## STEP 4

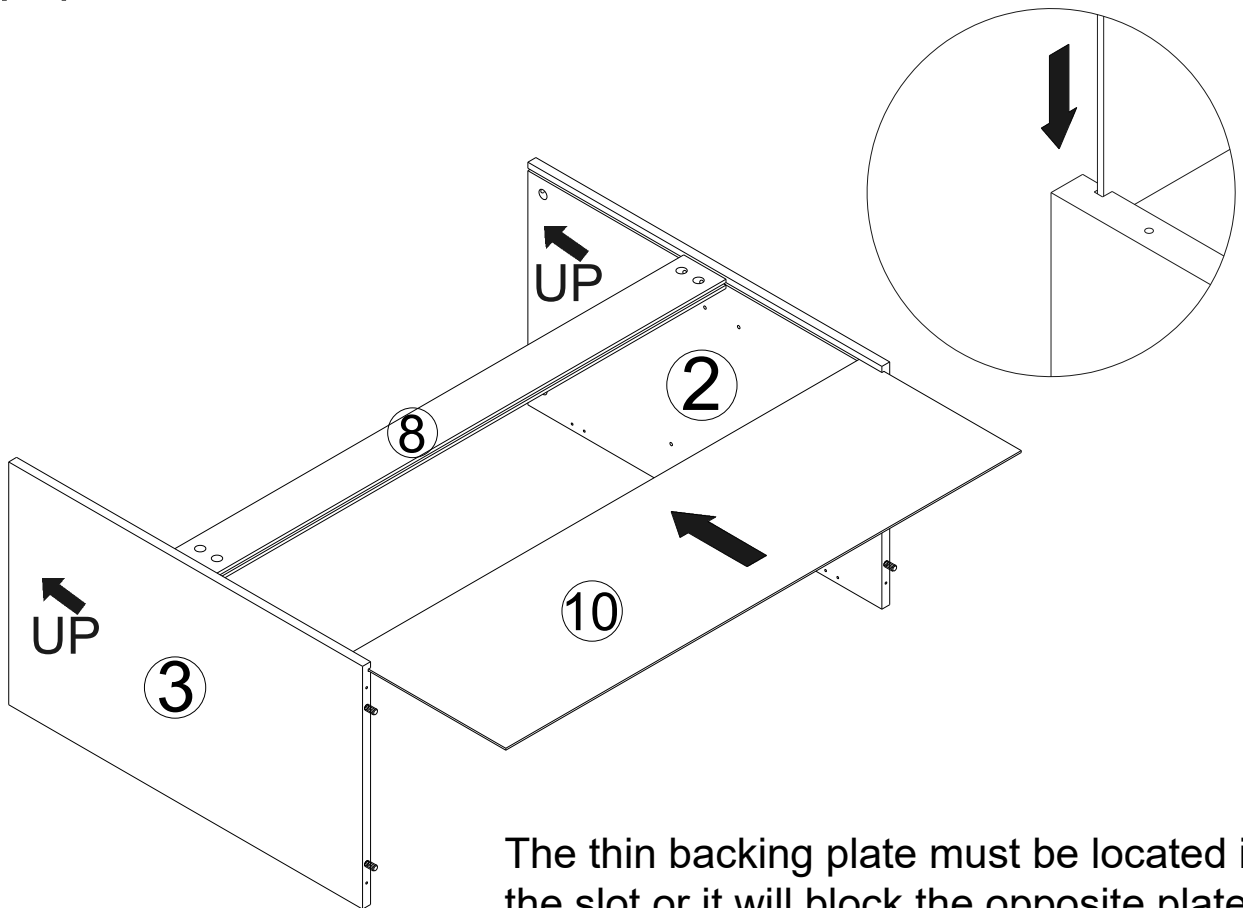

The thin backing plate must be located in the slot or it will block the opposite plate.

## STEP 5

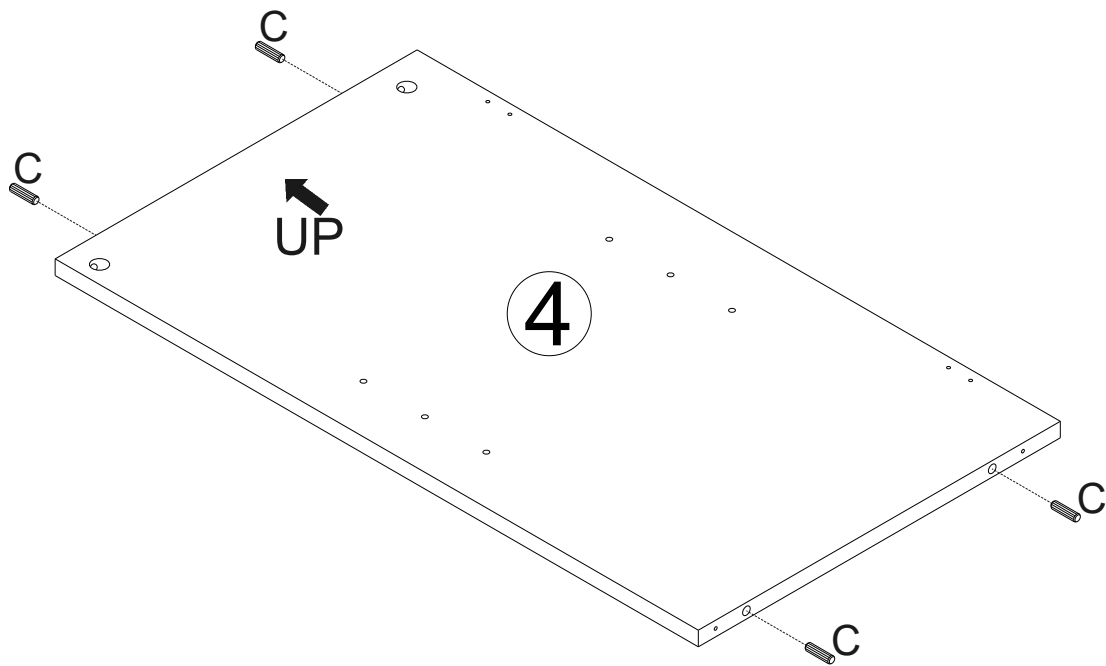



C\*4PCS

# Assembly Steps

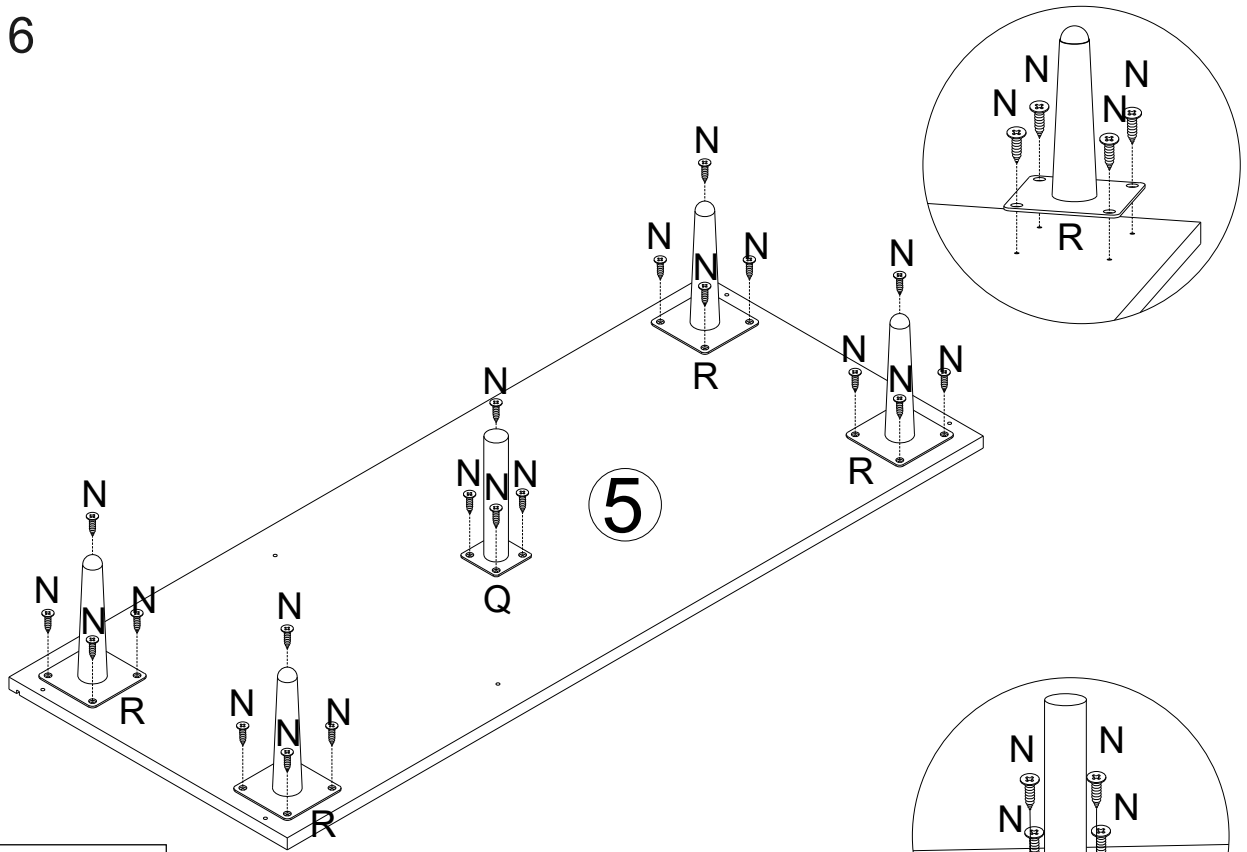
## STEP 6



	N*20PCS
	Q*1PC
	R*4PCS

## STEP 7

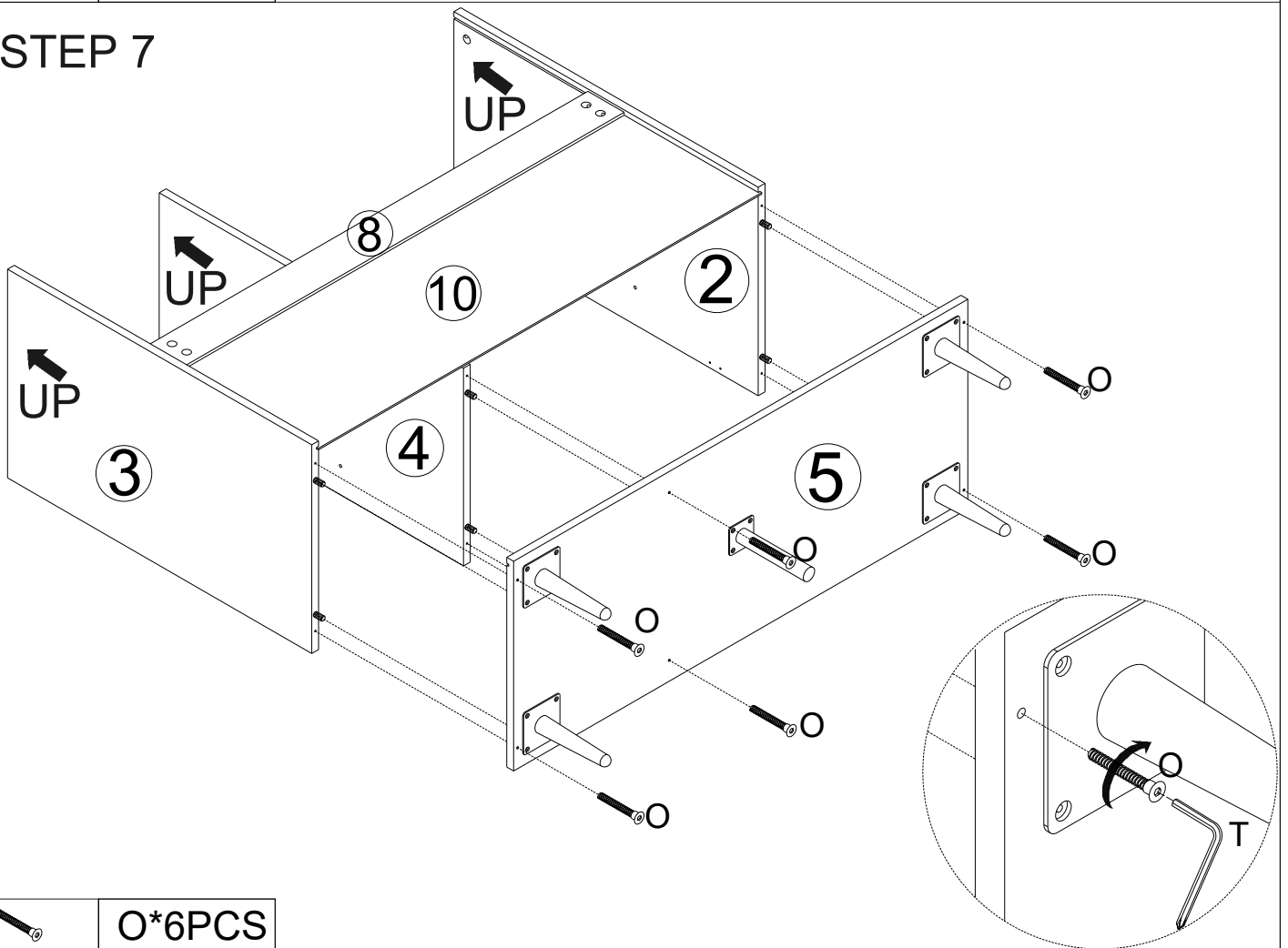

	O*6PCS
---	--------

# Assembly Steps

## STEP 8

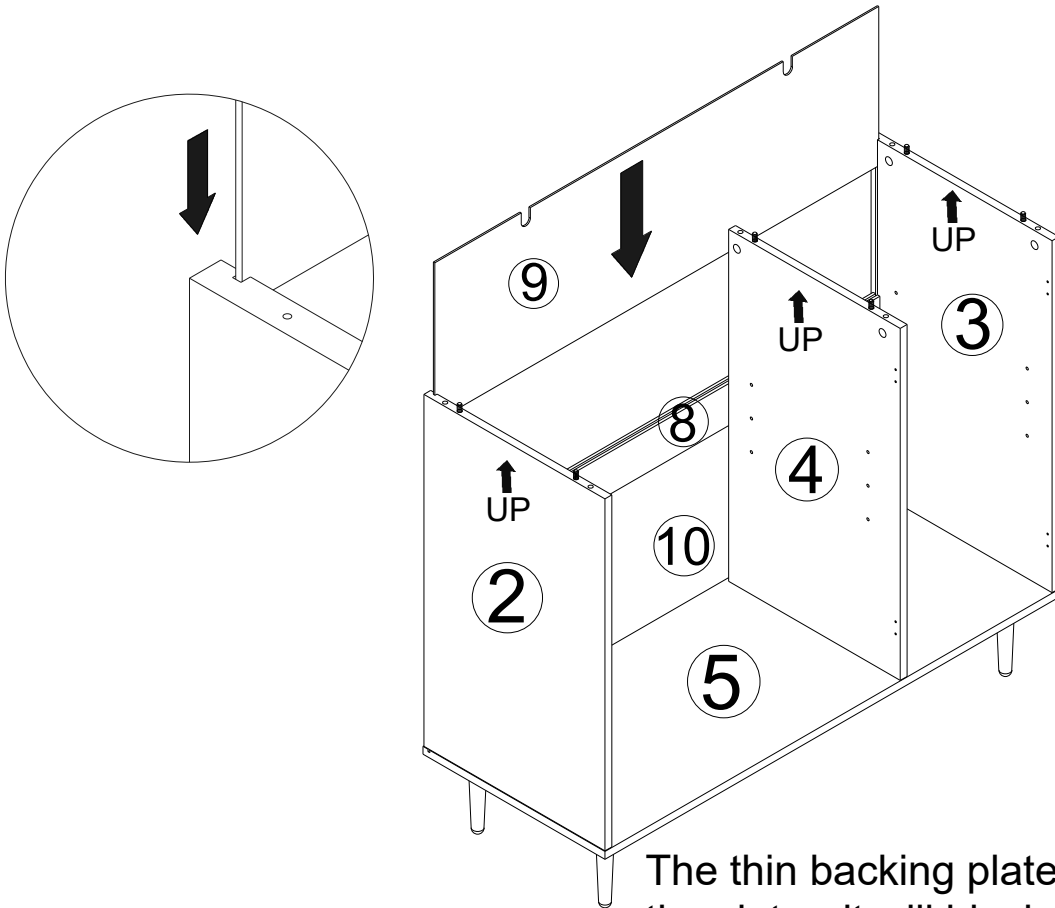

The thin backing plate must be located in the slot or it will block the opposite plate.

## STEP 9

# X3

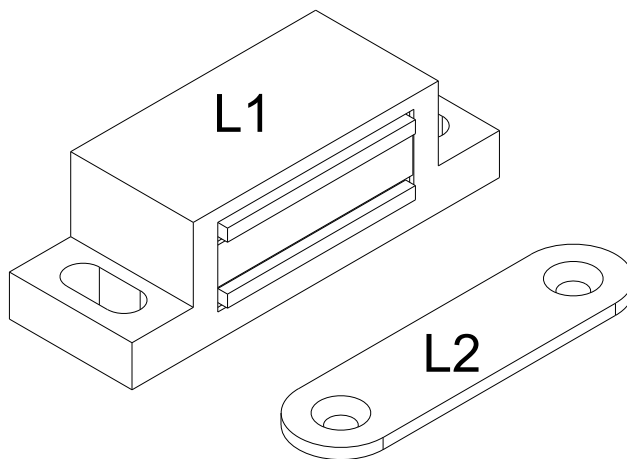



L\*3PCS

# Assembly Steps

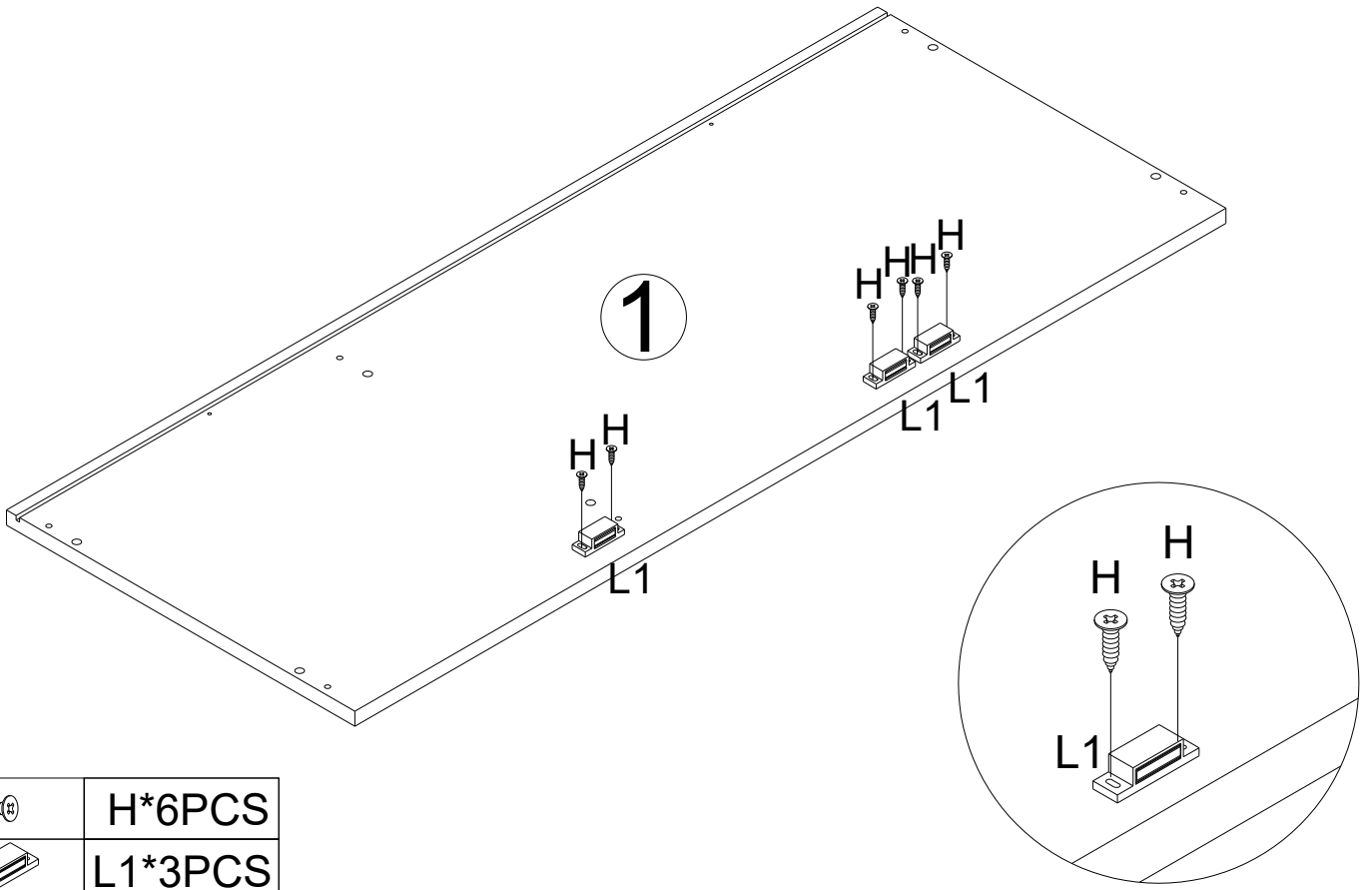

## STEP 10

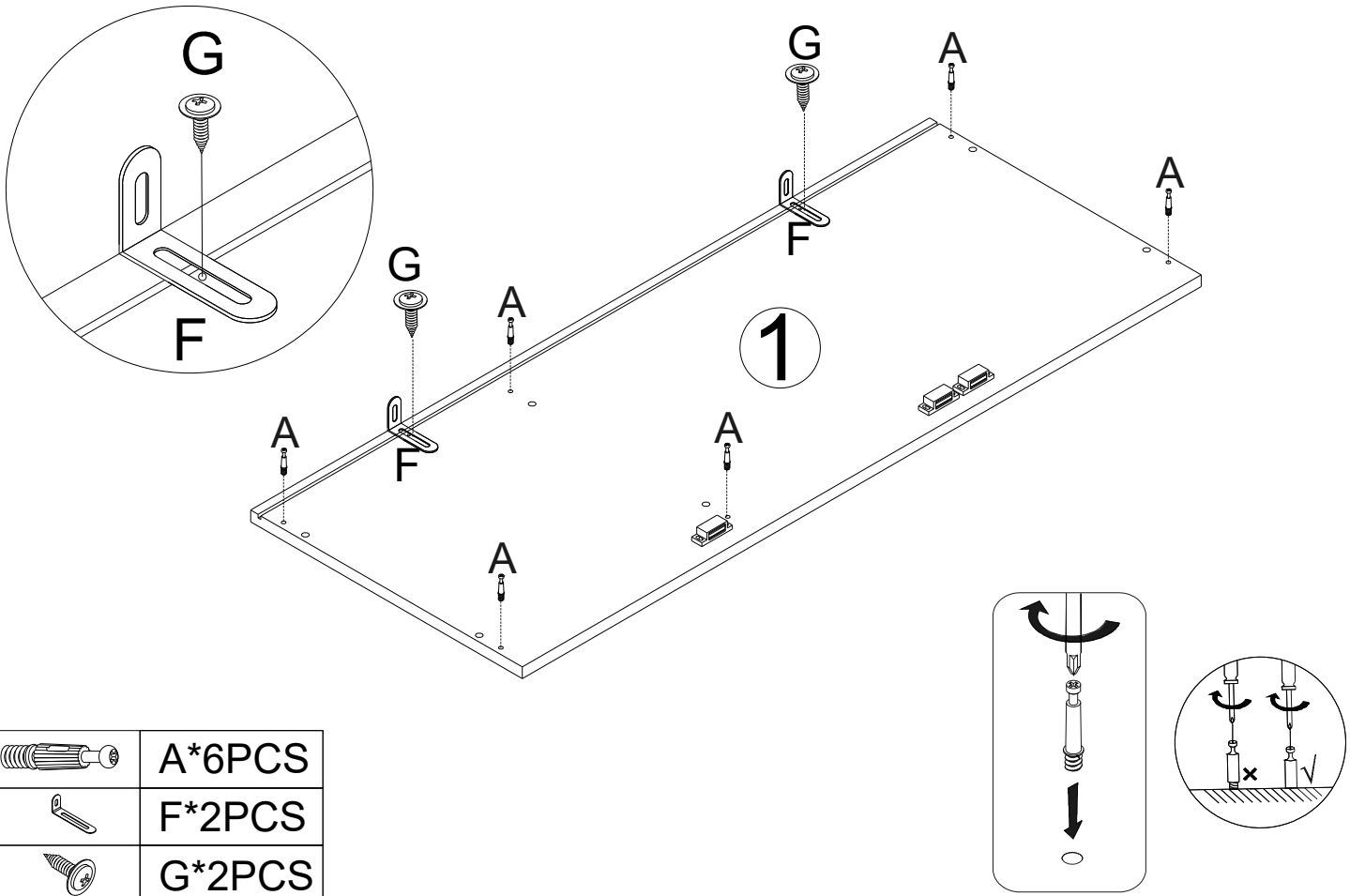

	H*6PCS
	L1*3PCS

## STEP 11



	A*6PCS
	F*2PCS
	G*2PCS

# Assembly Steps

## STEP 12

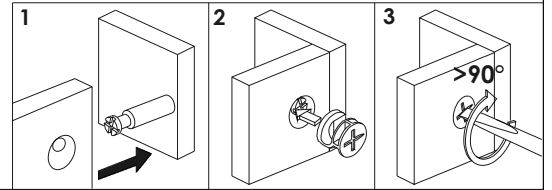
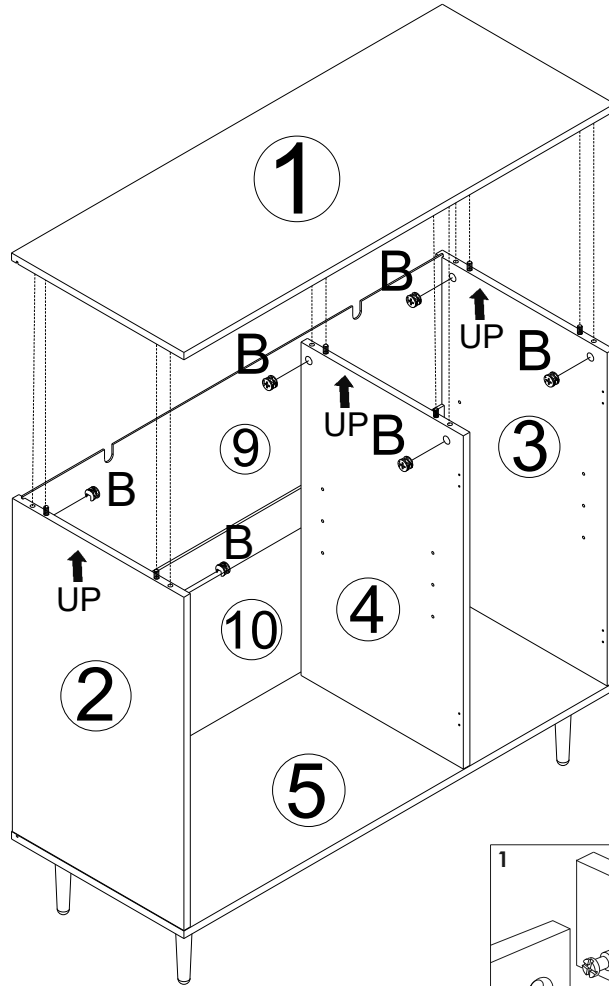

B\*6PCS

## STEP 13

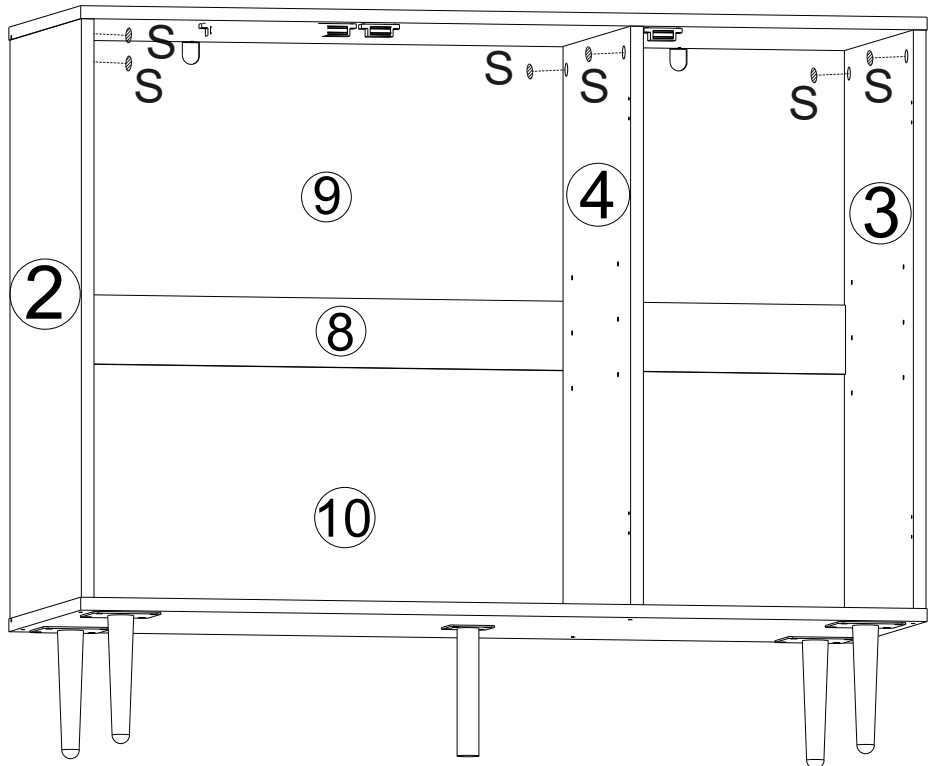
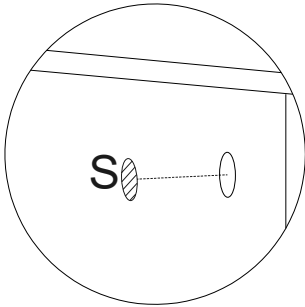

S\*6PCS

# Assembly Steps

## STEP 14

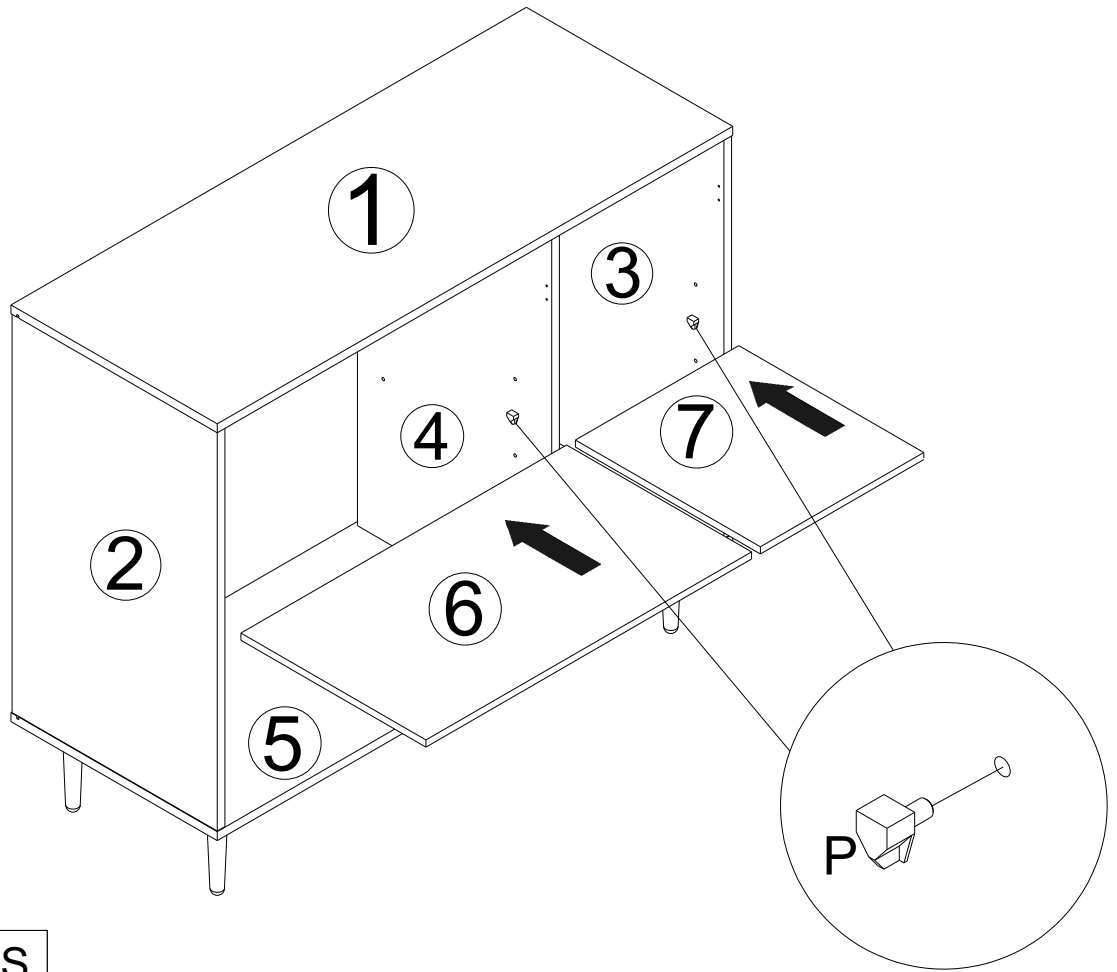

P\*8PCS

## STEP 15

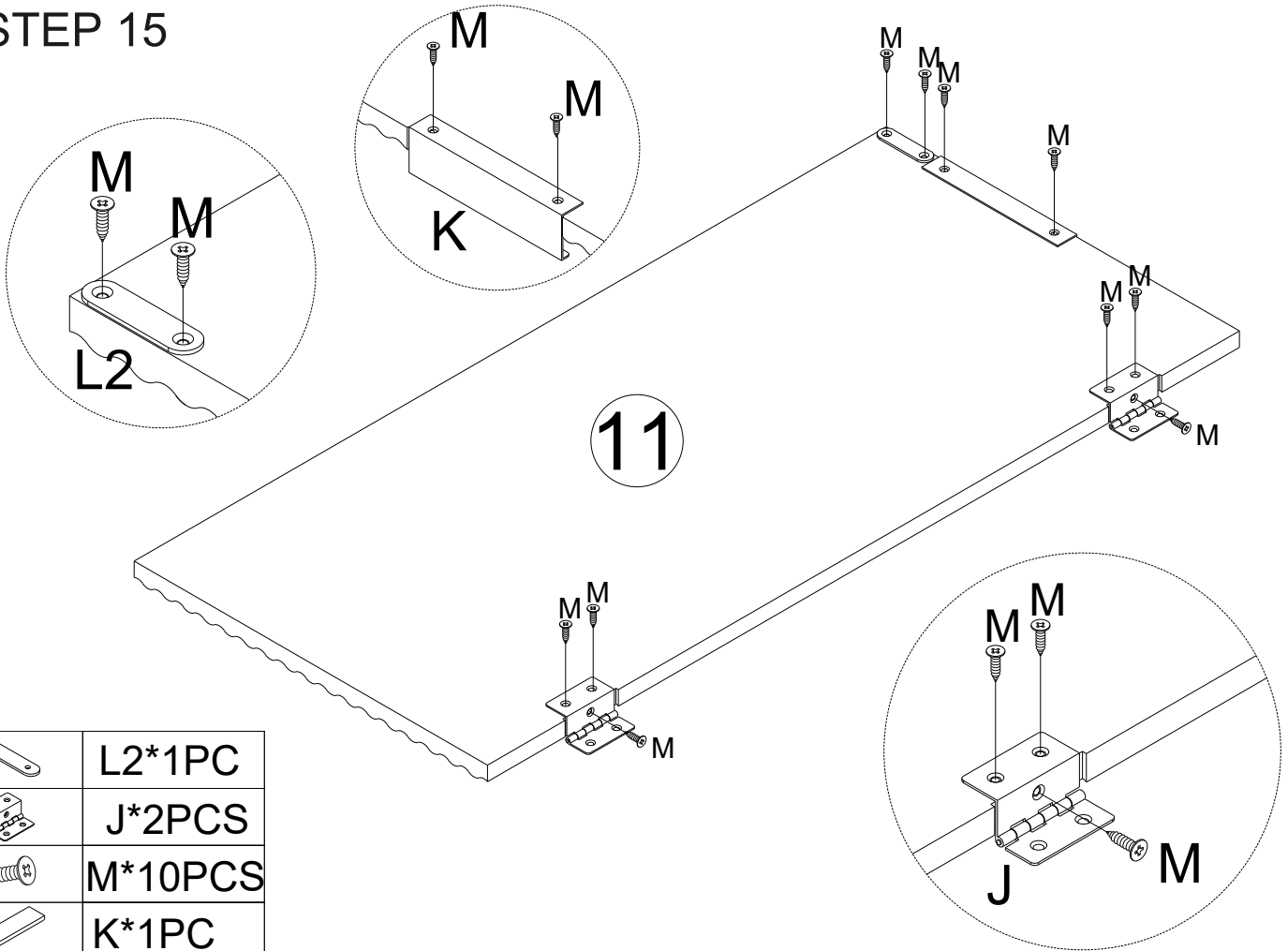

L2\*1PC



J\*2PCS



M\*10PCS



K\*1PC

# Assembly Steps

## STEP 16

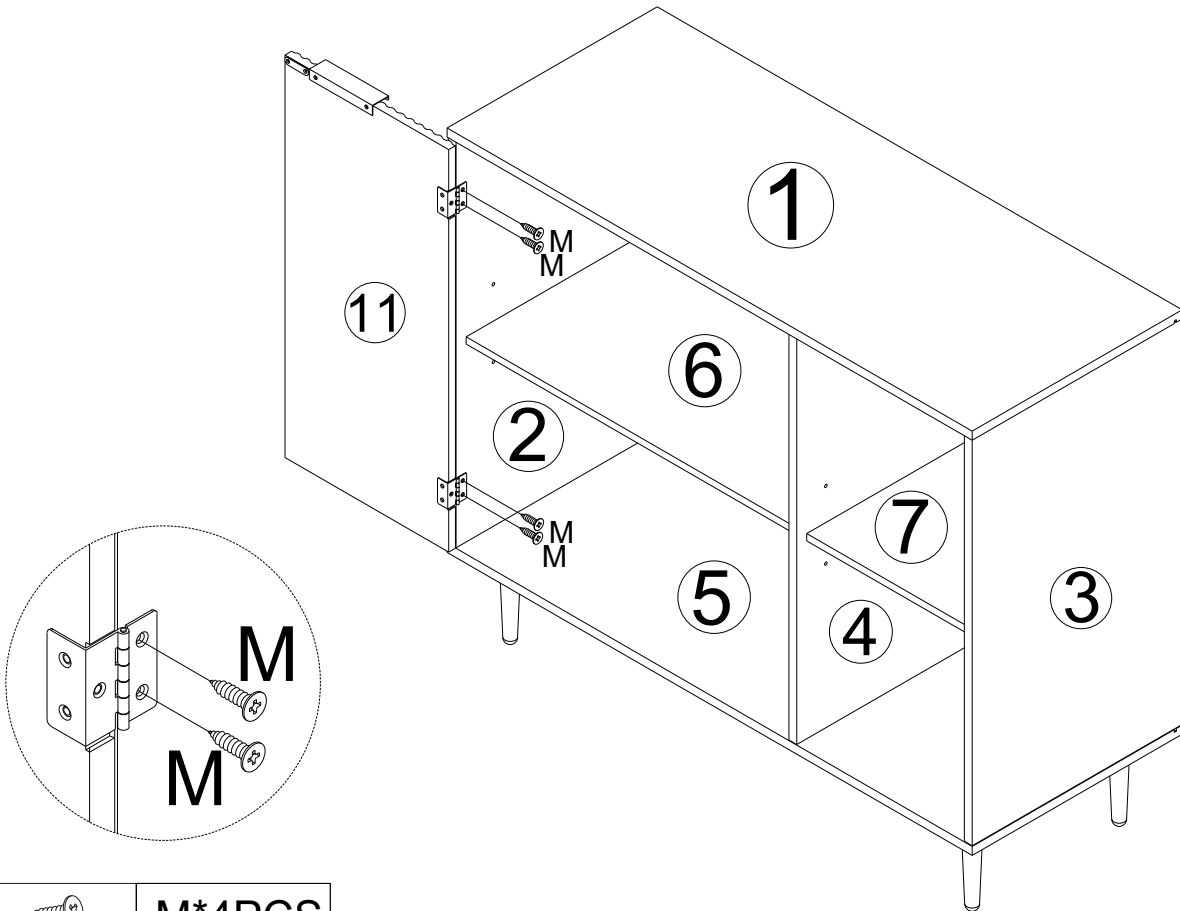

M\*4PCS

## STEP 17

X2

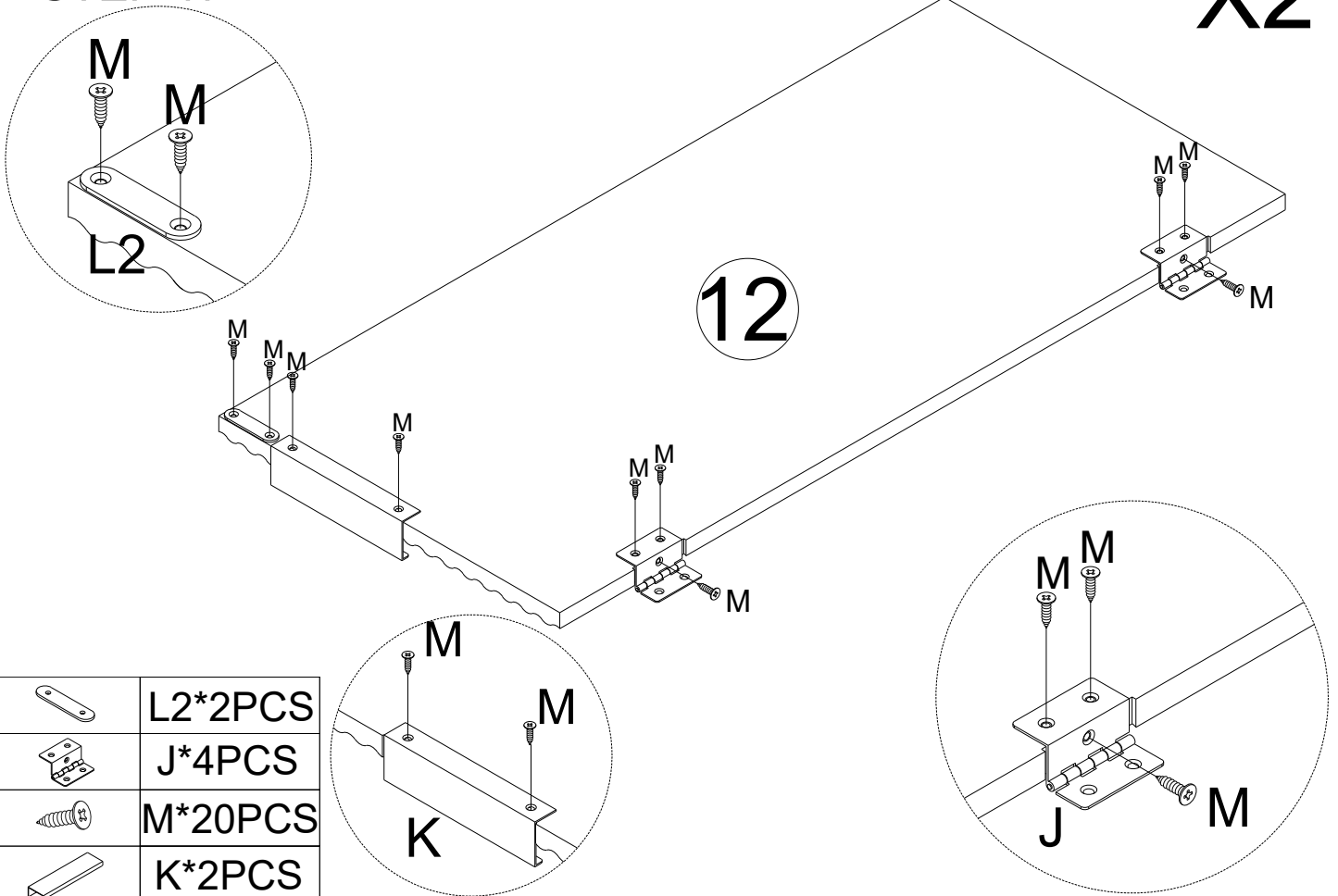

L2\*2PCS



J\*4PCS



M\*20PCS



K\*2PCS

# Assembly Steps

## STEP 18

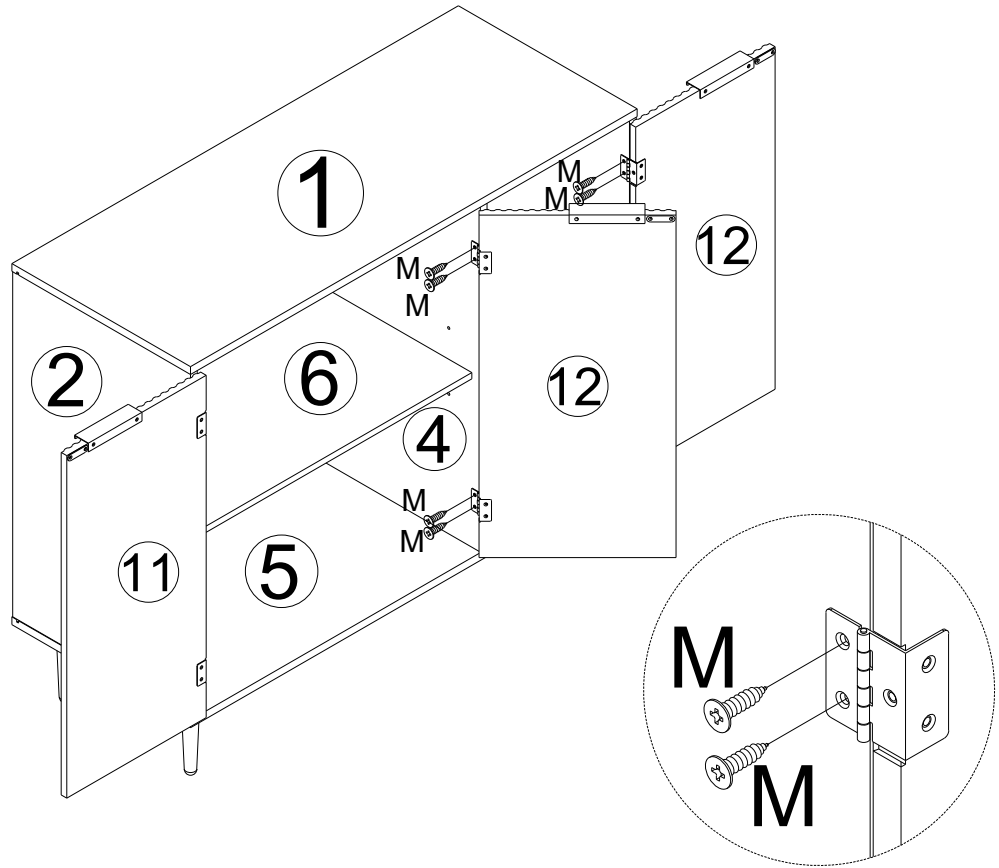

M\*8PCS

## STEP 19

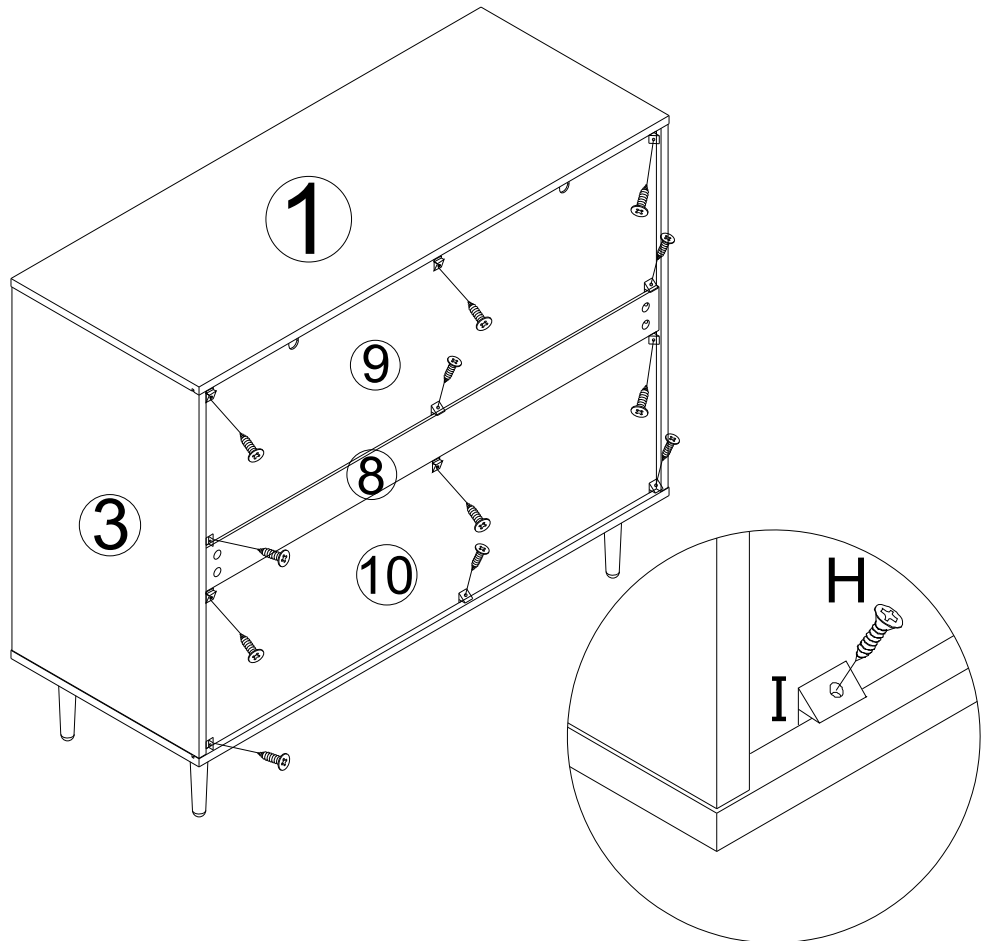

H\*12PCS



I\*12PCS

# Assembly Steps

## STEP 20

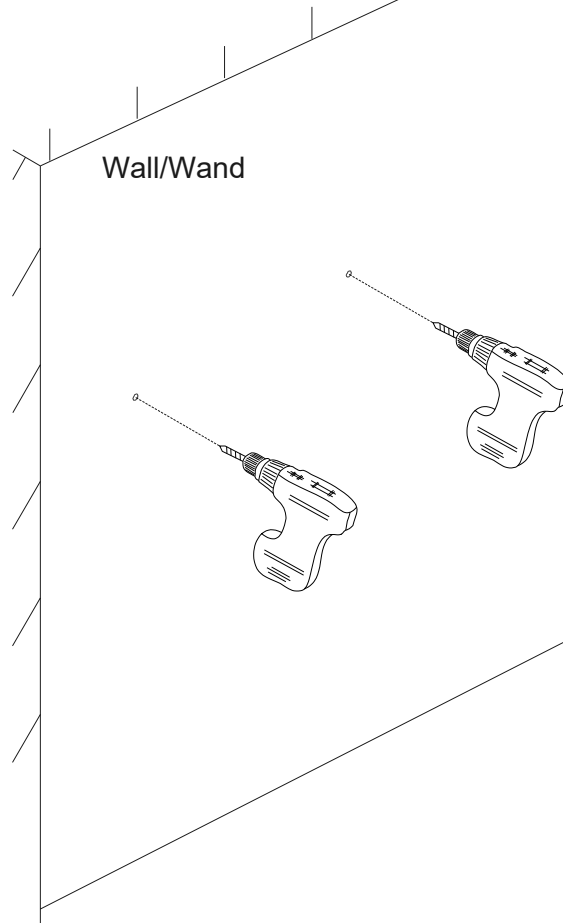

## STEP 21

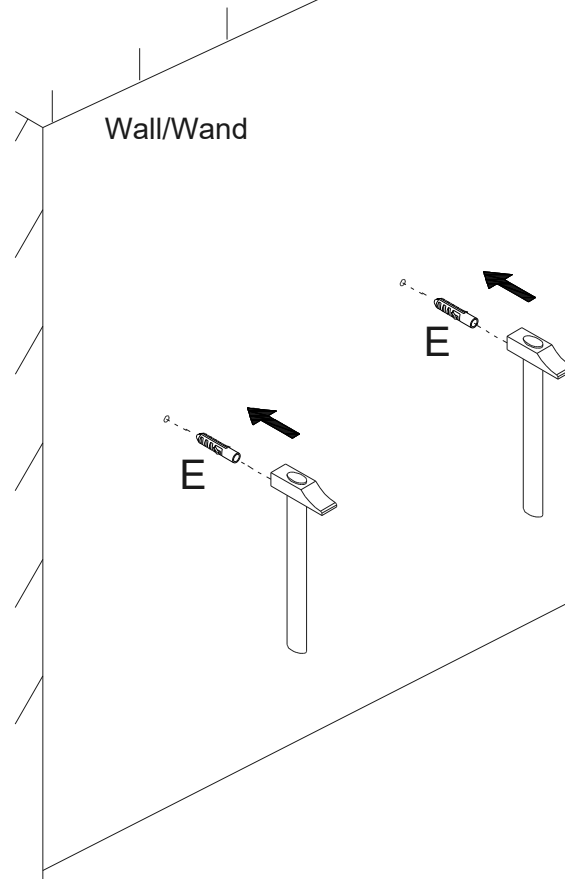

E\*2PCS

# Assembly Steps

## STEP 22

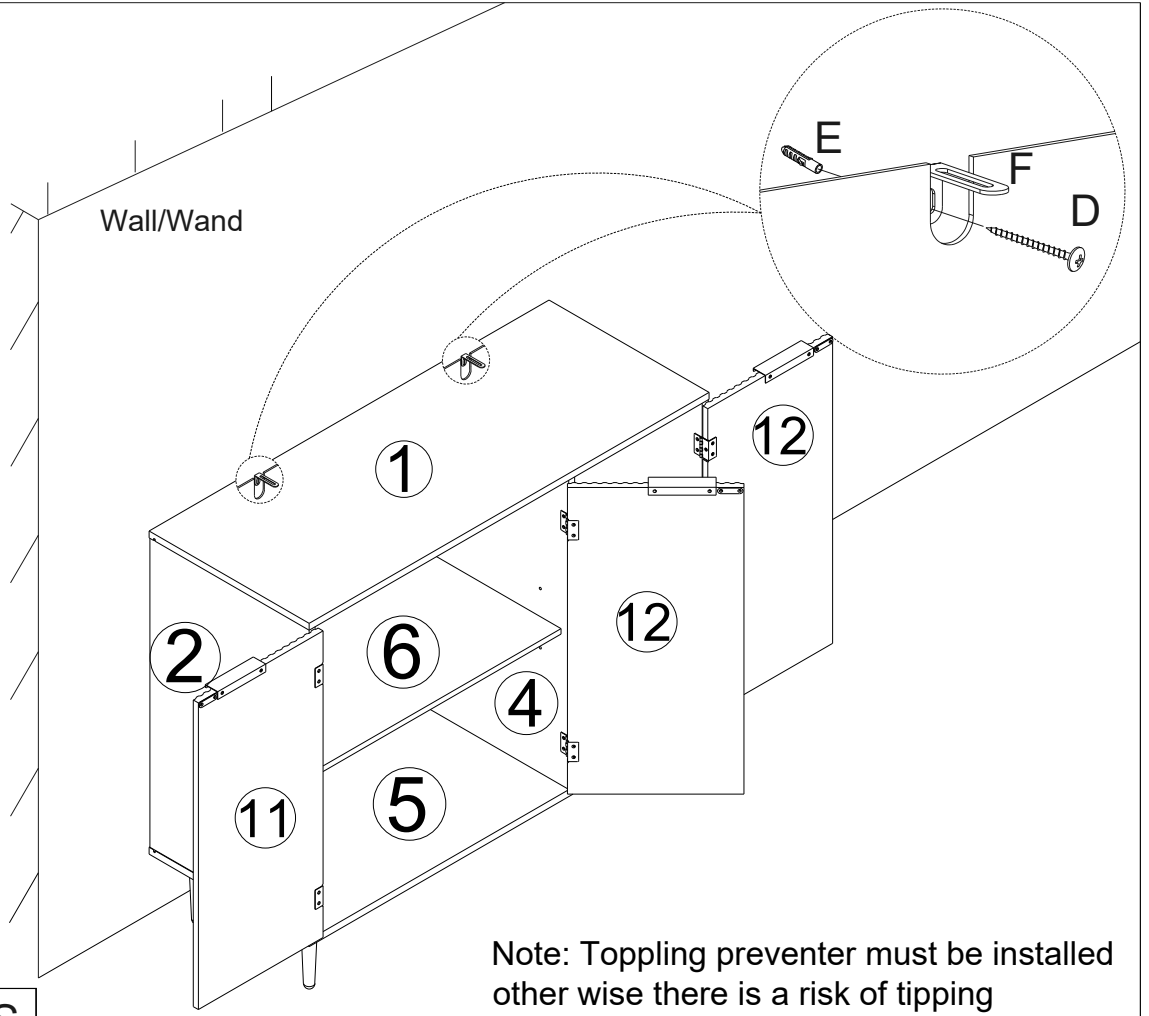

 D\*2PCS

Note: Toppling preventer must be installed other wise there is a risk of tipping

## STEP 23

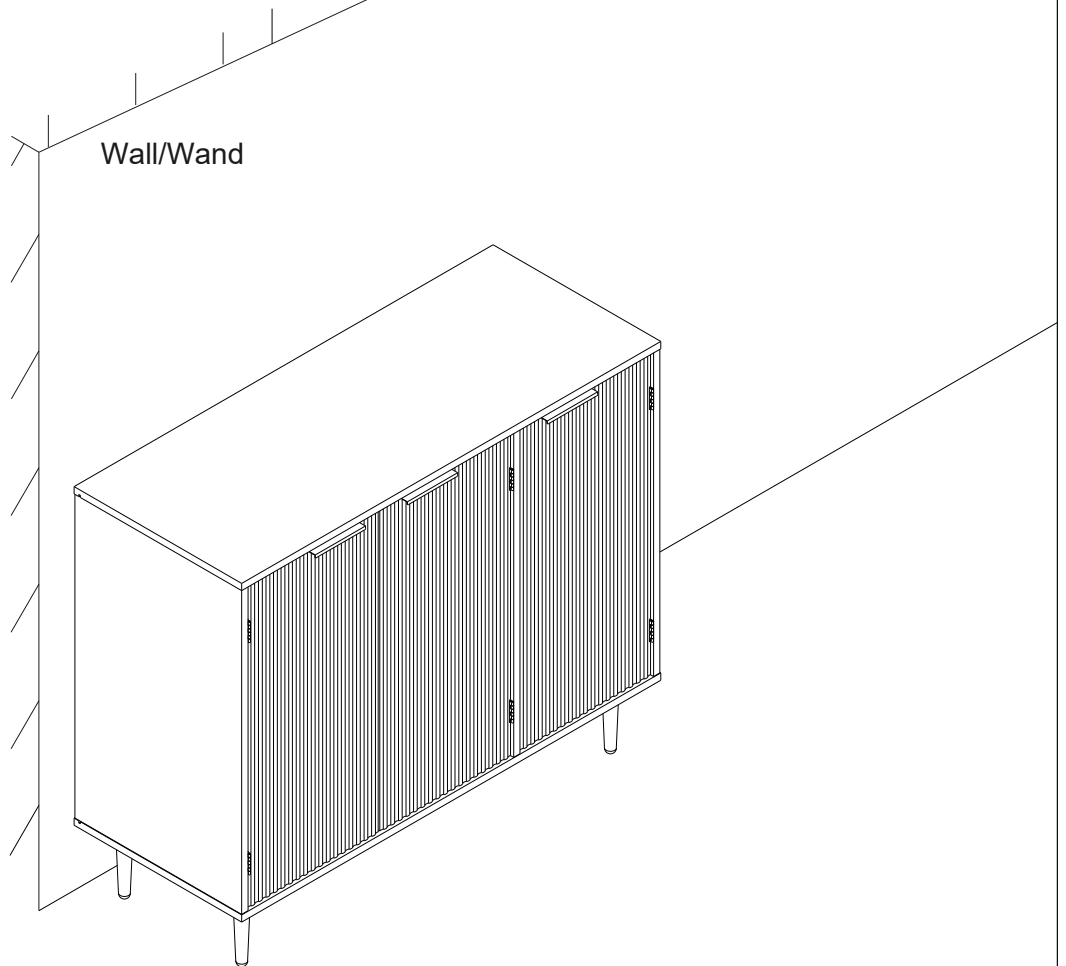

## WARNING



Children have died from furniture tipover. To reduce the risk of furniture tipover:

- ALWAYS install tipover restraint provided.
- NEVER put a TV on this product.
- NEVER allow children to stand, climb or hang on drawers, doors, or shelves.
- NEVER open more than one drawer at a time.
- Place heaviest items in the lowest drawers.

