











Assembly Instructions

Caution: You must read this before you proceed.



Care & Maintenance

- ✓  • Furniture may scratch floors. We recommend using furniture pads to protect your floors.
 - ⊘  • Do not put hot items directly on furniture surface.
 - ⊘  • Do not clean furniture with harsh cleansers or polish.
 - ⊘  • Do not place furniture under direct sunlight.
 - ⊘  • Do not place furniture near heating or cooling vents.
 - ⊘  • Do not write on furniture without a padded barrier to protect the surface.
 - ⊘  • Do not place furniture outside . For indoor use only.
 - ⊘  • Not for commercial use. For residential use only.
 - ⊘  • Stains may be removed with mild soap solution and damp cloth.
 - ⊘  • Children should not climb or jump on the furniture.
-
- ✓  • Dust and pick-up spills using a clean, non-colored, lint-free cloth.

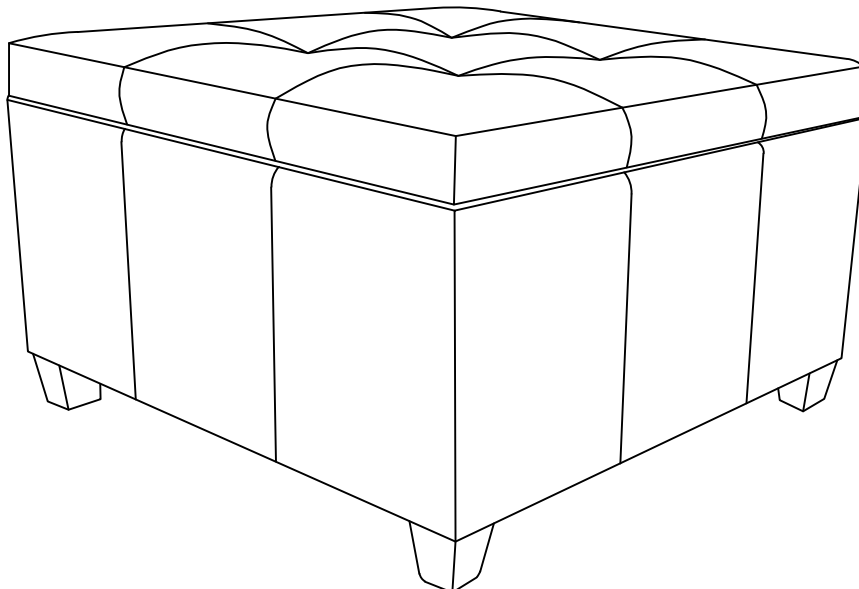
Ottoman

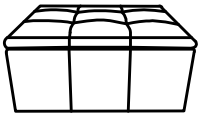

Parts List For 1 Ottoman

Label	Picture	Description	Qty
A		Ottoman	1
B		Wooden Leg	4

Hardware For 1 Ottoman

Label	Picture	Description	Qty
①		Washer Ring	5

Assembly Preparation

Before Beginning Assembly:

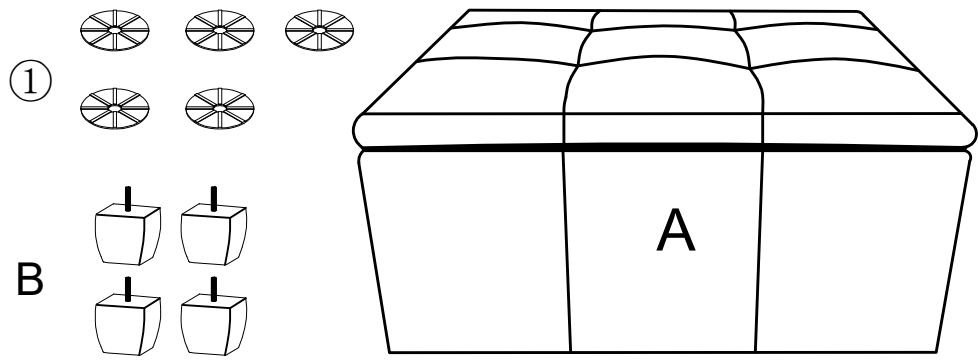

- Read instructions, cover to cover-



- Have 2 adults on hand for assembly-



- Do not assemble on flooring or carpet-



- Assemble on a clean non-marring surface (packing foam)-



- Save all packaging until finished-

Assembly Steps

Overview

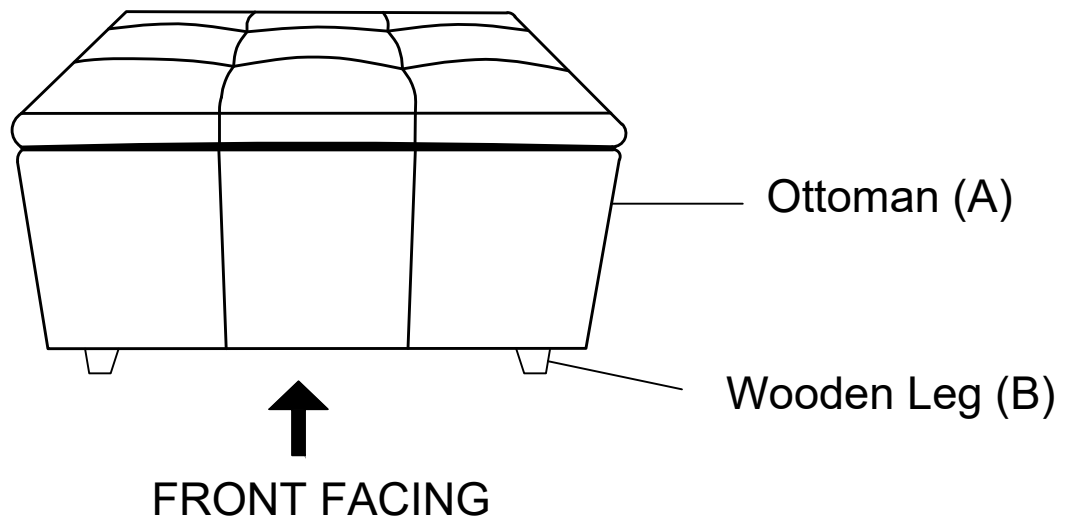

This Ottoman has multiple parts and may require up to 30 minutes to assemble. To give you an overview of the Ottoman parts, the above picture is to help you put the various parts into perspective. Please read through the instructions below to familiarise yourself with the parts and steps before assembly.

Step 1

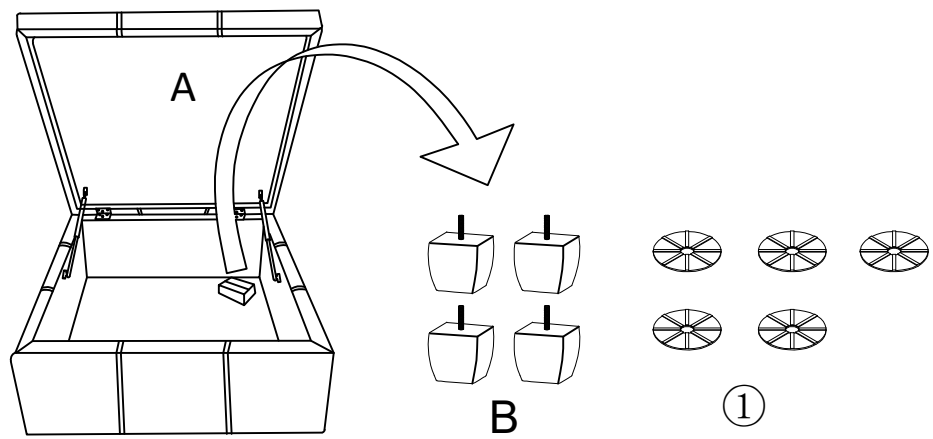

Open the Ottoman Storage and you will see legs inside the Ottoman.
Remove the 4 Wooden Legs.

Step 2

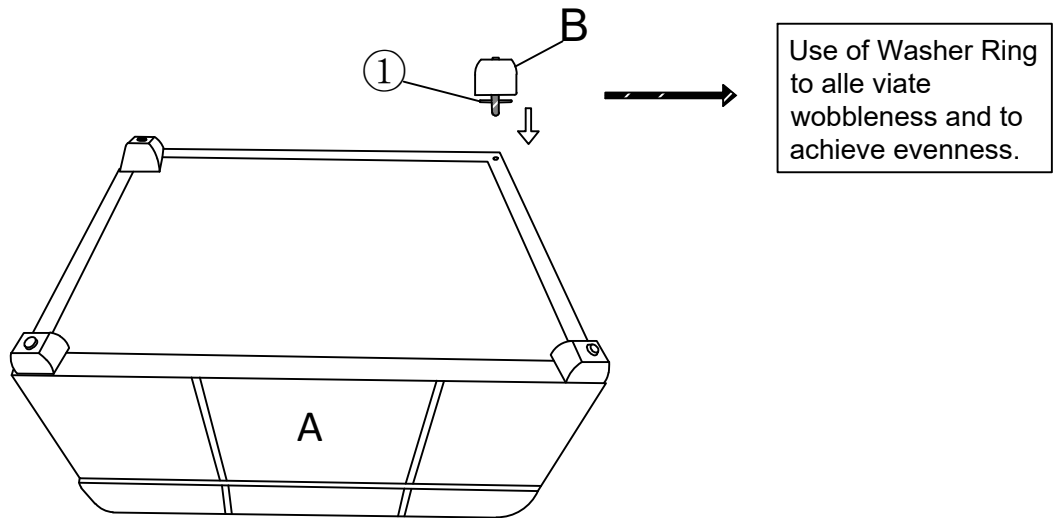

Place the Ottoman face down, as shown above.
Install the Leg(B) into the bottom of the Ottoman(A) by placing 1 (ONE) piece of Washer Ring(1) on the threaded stem.
The use of Washer Rings improves tightness and security of legs after assembly.
Tighten by turning the leg clockwise.
Repeat the same step to install the three remaining legs.
Note: The use of Washer Rings are OPTIONAL and is especially useful to help alleviate slight wobbleness. Some Legs may need more than one whilst some legs do not need any.

Step 3

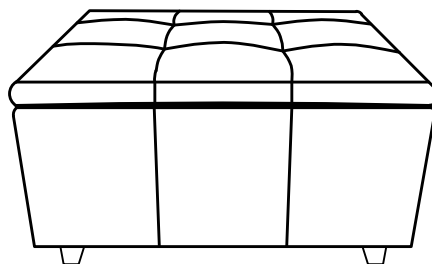

Place the Ottoman right side up and it is ready to be used.
Caution: This Ottoman only be used on a flat, level surface.