

B5051-K

**PARTS**

#1 x 1pc

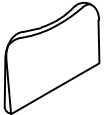

Headboard

#2 x 1pc

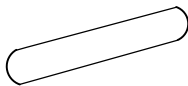

Footboard

#3 x 2pcs

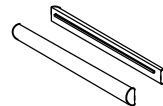

Side Rail

#4 x 2pcs

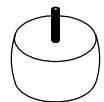

Leg

#5 x 8pcs



Support Leg

#6 x 2pcs

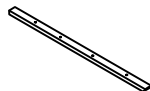

Support Rail

#7 x 1pc

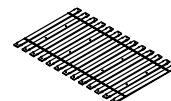

Slat

#8 x 2pcs



HB LEG

#9 x 4pcs



Connection strap  
(L/R)

**HARDWARE**

#A x 16pcs



Bolt Ø5/16" x 1-1/2"

#B x 6pcs



Threaded Stud  
Ø5/16" x 3-1/4"

#C x 6pcs



Hex Nut Ø5/16"

#D x 22pcs



Flat Washer Ø1/4"x19mm

#E x 22pcs



Lock Washer Ø5/16"

#F x 1pc



Wrench 12mm

#G x 26pcs

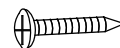

Screw #8x1-1/2"











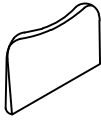
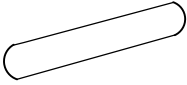



#H x 1pc

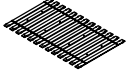

Allen Wrench M5

**B5051-K**

**B5051-K packed in 2 cases**

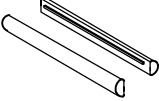
Carton	DESC.	Part	Q.TY	Hardware
B5051-K-1	Headboard	#1	 1pc	
	Footboard	#2	 1pc	#A x16pcs  Bolt Ø5/16" x 1-1/2"
	Leg	#4	 2pcs	#B x 6pcs  Threaded Stud Ø5/16" x 3-1/4"
	Support leg	#5	 8pcs	#C x 6pcs  Hex Nut Ø5/16"
	Slat	#7	 1pc	#D x 22pcs  Flat Washer Ø1/4"x19mm
	HB LEG	#8	 2pcs	#E x 22pcs  Lock Washer Ø5/16"
	Connection strap	#9	 4pcs	#F x 1pc  Wrench 12mm
	Support Rail	#6	 2pcs	#G x 26pcs  Screw #8x1-1/2"
	B5051-K-2	Side Rail	#3	 2pcs

# ASSEMBLY INSTRUCTIONS

## STEP 1

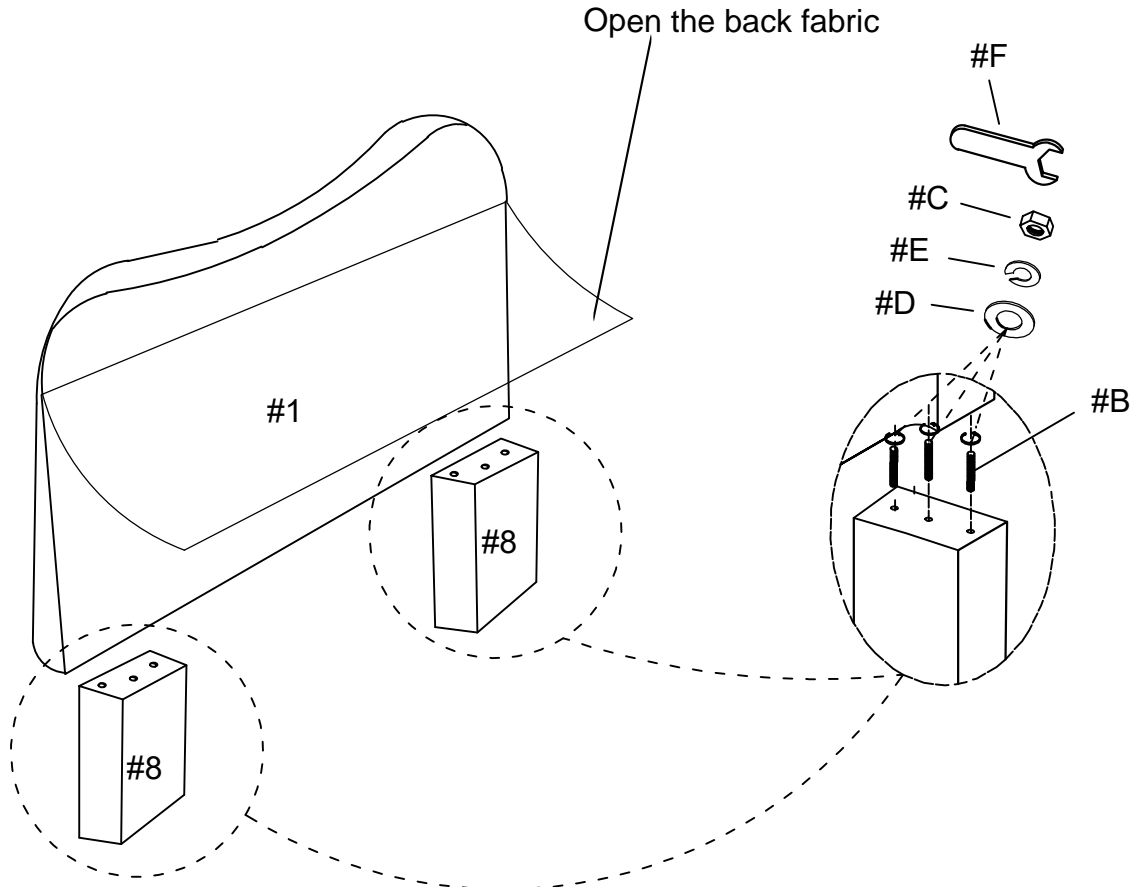

## STEP 2

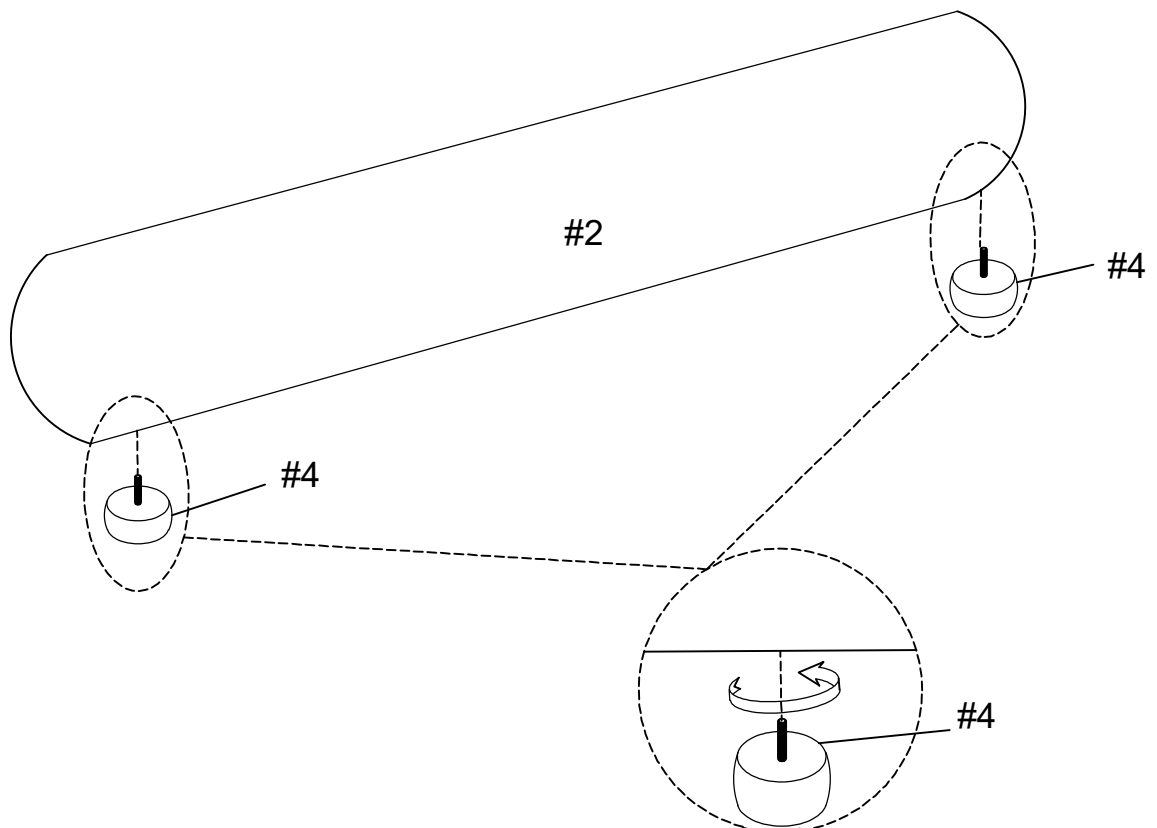

# ASSEMBLY INSTRUCTIONS

## STEP 3

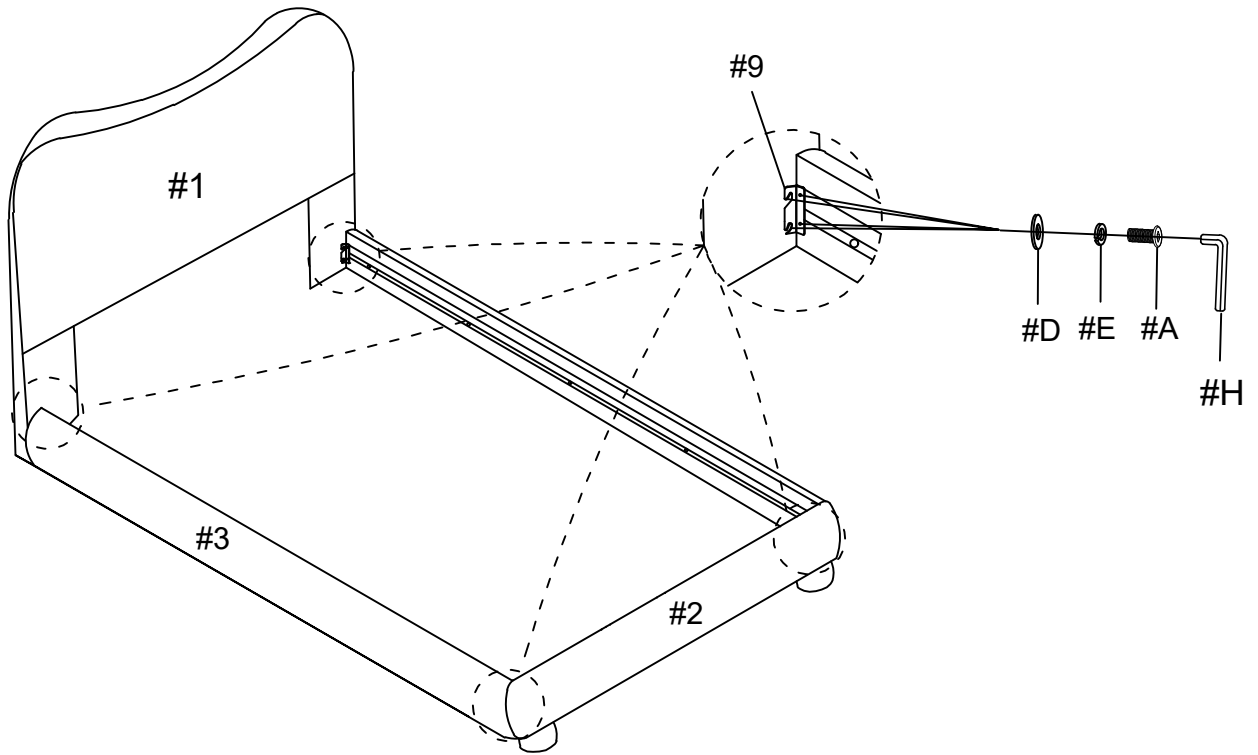

## STEP 4

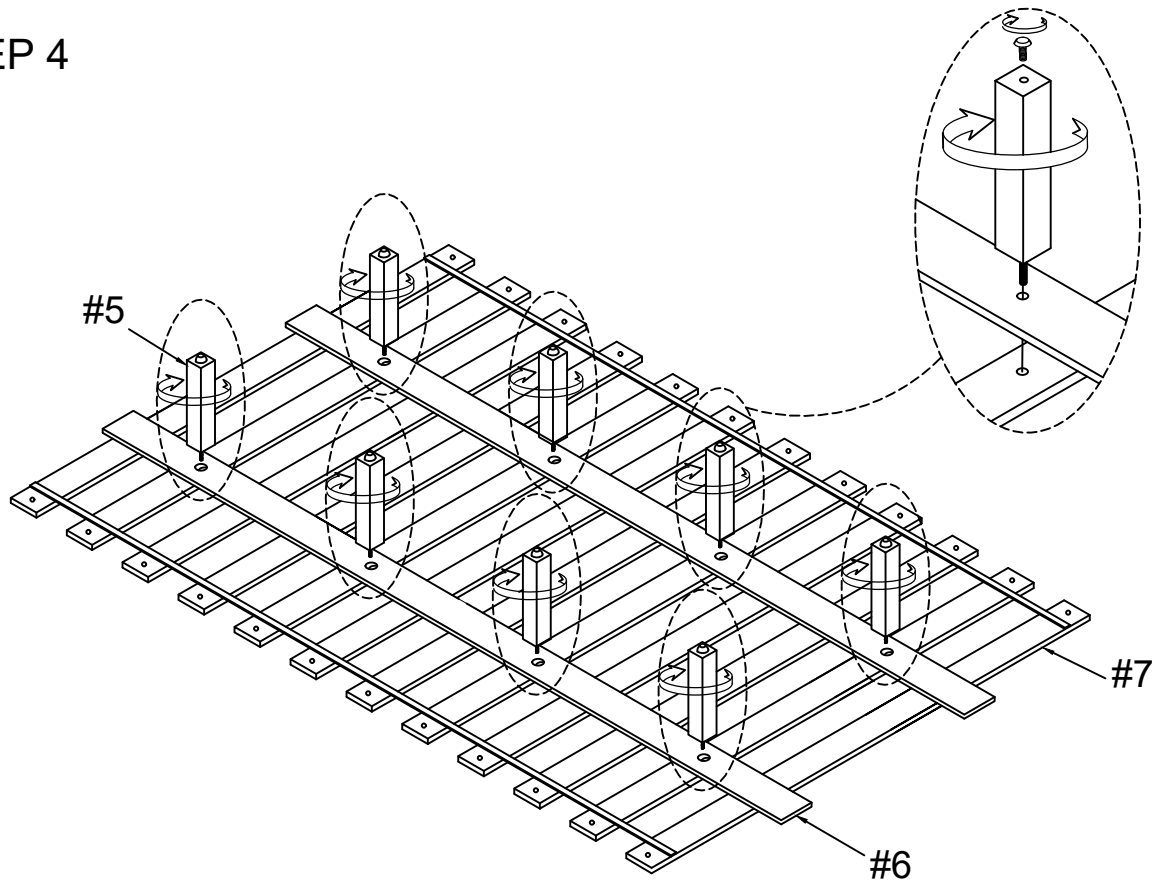

# ASSEMBLY INSTRUCTIONS

STEP 5

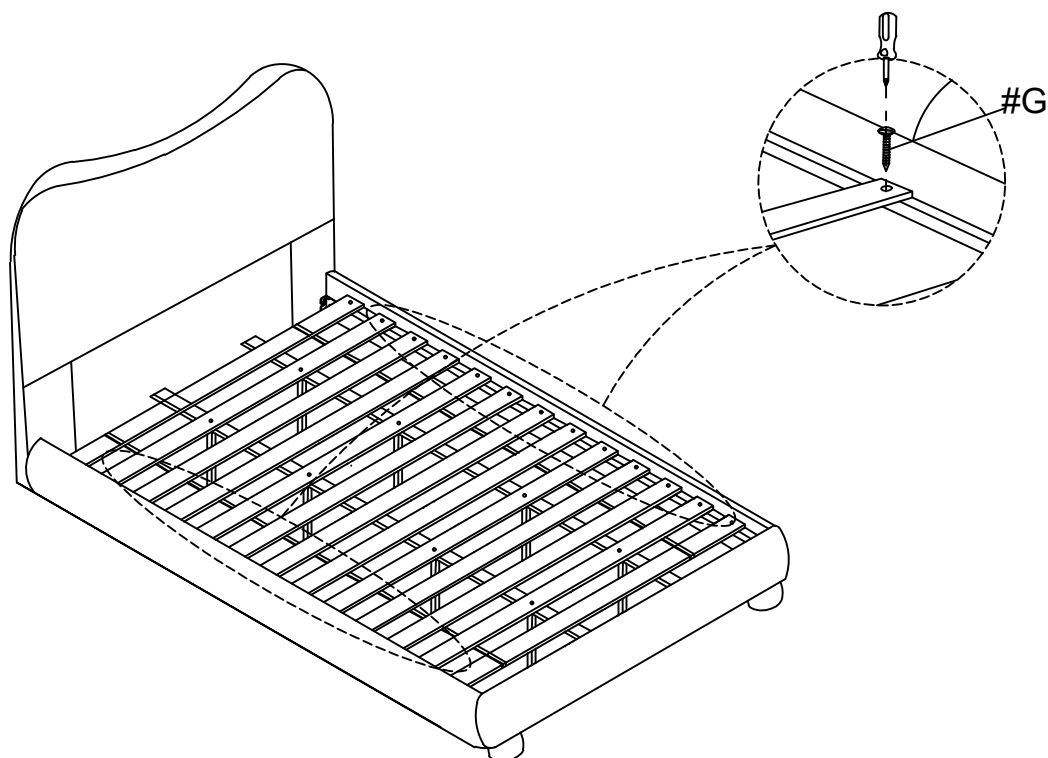

STEP 6

